

## MSI Safety controllers and safety relays

Safety at Leuze



# Safety at Leuze

The advance of automation in industry places increased demands on safety concepts. Automation continuously gives rise to new requirements aimed at ensuring the safety of persons. At the same time, the importance of smooth processes is growing constantly as a result of automation and networking.

Our driving force is the desire to guarantee you gapless safety, efficient material flow and maximum availability at all times. This is why we have bundled our expertise in work and machine safety into one portfolio so that together with you we can find optimum solutions to these challenges: Safety at Leuze.



### Experts for your application

Effective solutions begin with a comprehensive understanding of the relevant requirements. Our specialized application know-how and many years of experience in our core industries mean that we can offer a unique insight into safety-related applications. Coupled with extensive knowledge of norms and standards, we provide you with targeted answers that are able to solve even complex challenges effectively and efficiently.



### Everything from a single source

Individual requirements need flexible solutions. Our high-quality products and intelligent systems as well as competent technical advice and support form the basis of our safety portfolio. Benefit from our extensive range of products. The diversity of our portfolio means that we are able to provide you with all components, from sensor to control, from a single source – all with maximum user-friendliness and all optimally matched to each other.



### Experienced safety specialists

Sustainable machine safety begins with professional planning of the safety systems. It spans the entire lifecycle of a machine. Let our experienced and certified safety experts support you with competent advice. Take advantage of over 30 years of experience in machine safety and the passionate commitment of the Sensor People.



### Innovative safety

New challenges call for innovative approaches. We are constantly developing new products and system solutions in order to meet existing requirements even better and to meet new challenges effectively. Particularly in the area of optical sensors, new technological concepts mean that we are able to set milestones again and again. From the very first photoelectric sensor to concepts such as Smart Process Gating – we actively shape the advances made in industry.

## Safety controllers and relays

Regardless of whether you would like to integrate safety sensors, switches or command devices in the safety circuit of the machine control: the MSI safety controllers and safety relays ensure efficient integration of all safety devices.



### Safety controllers

For small- to medium-size machines, compact safety controls are increasingly being used for monitoring the safety circuit. They simultaneously evaluate multiple safety sensors and can easily be adapted to the respective requirements by means of their configurable safety functions.

With their simple commissioning, flexible configuration options and wide range of on-board functionality, the MSI 400 programmable safety controls offer optimum solutions. If necessary, the devices can be modularly expanded, and projects can be easily and efficiently designed using the license-free MSI.designer configuration software.



### Safety relays

For individual sensors, safety relays offer integration with minimum effort. Our extensive product range of individually tailored and universal devices offers efficient solutions for every requirement.

### Selection guide

Various requirements are to be taken into account when selecting the appropriate evaluation unit. Classic safety relays offer the simplest and most economical solution when using a small number of sensors. As the number of safety sensors increases and for more complex safety functions, the strengths of the safety controllers become apparent: they offer space and cost advantages and can be flexibly adapted to various requirements through their configurable safety functions.

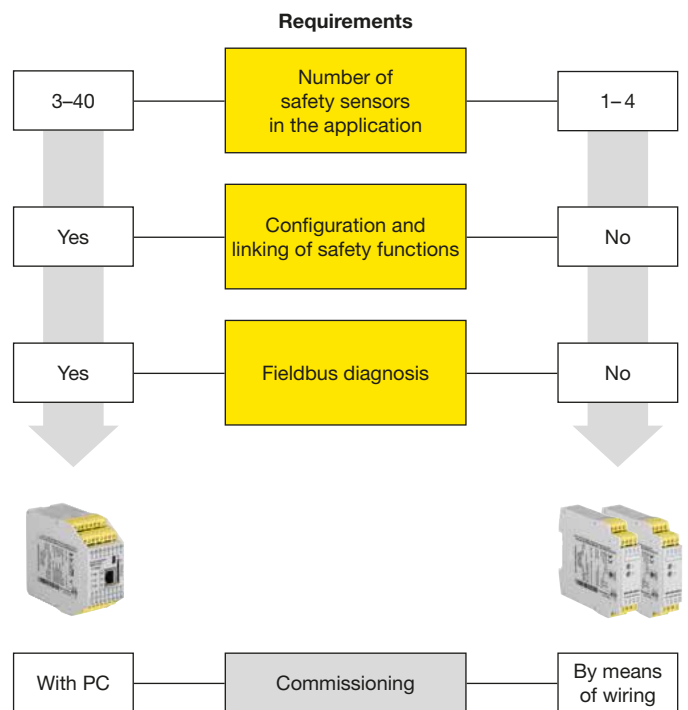



# Evaluation of safety sensors by safe control components

## Evaluation of multiple safety sensors with configurable safety functions

**Requirement:** Multiple safety sensors must be integrated into the machine or system control. Functions such as a time delay for releasing a locking device or signal connections are also to be configured.



**Solution:** The basic module of the MSI 400 expandable safety control already has 24 safe inputs/outputs as well as an Ethernet interface with Industrial Ethernet protocols. The safety control can be configured quickly and efficiently using the license-free configuration software MSI.designer.

## Safe monitoring of presses

**Requirement:** The specific requirements on the safety of presses defined mechanical and hydraulic presses in the EN ISO 16092 standards. The implementation of these requirements and the integration in the press operating sequence are to be supported and simplified by the configuration tool.

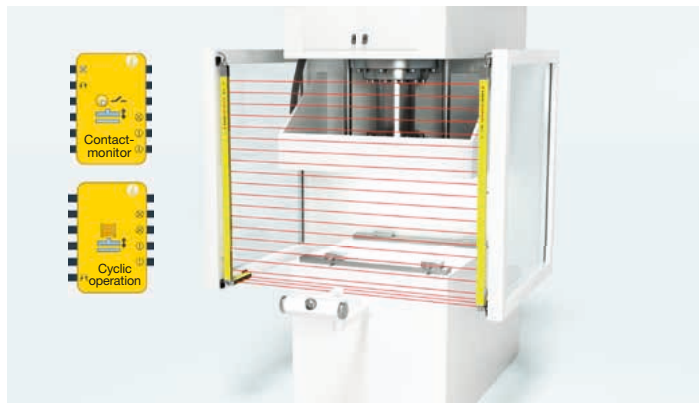

**Solution:** Especially well suited for use on eccentric and hydraulic presses the configuration tool MSI.designer offers a special function library. This contains tailored function blocks for the control and safeguarding of presses, and therefore make quick and easy configuration possible.

## Access guarding on conveyor lines, with muting function

**Requirement:** Access guarding on conveyor lines is to prevent persons from accessing the danger zone, while at the same time allowing the transported goods to pass through.



**Solution:** The muting function bridges the safety sensor in a controlled manner to allow the transported goods to pass through. Here, the special muting function blocks of the MSI 400 safety control or the MSI-MD-FB muting interface, which is designed as a field module, handle the control of the muting sequence.

## Evaluation of individual safety sensors

**Requirement:** For correct execution of the safety function, safety sensors must be integrated into the machine circuit using safe control components in accordance with the requirements defined in ISO 13849-1.

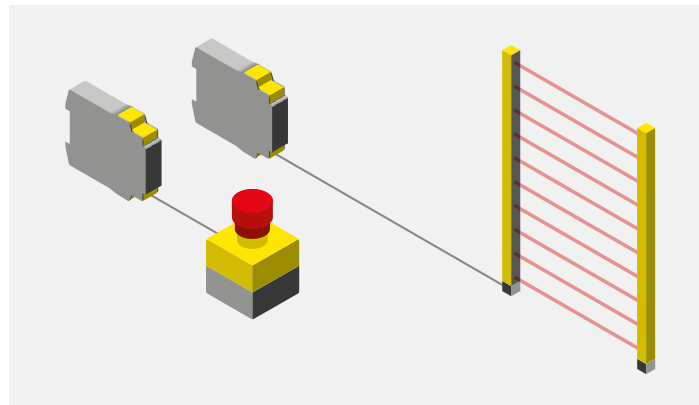

**Solution:** With the reliable MSI safety relays, individual safety sensors can be integrated quickly and easily into the safety circuit of machines and systems. Depending on the model, the relays are tailored to specific applications or can be used universally.

## Evaluation of two safety sensors with one safety relay

**Requirement:** If two safety sensors act on a common shutdown path, they are to be integrated in the machine circuit by means of an economical and space-saving safety relay.

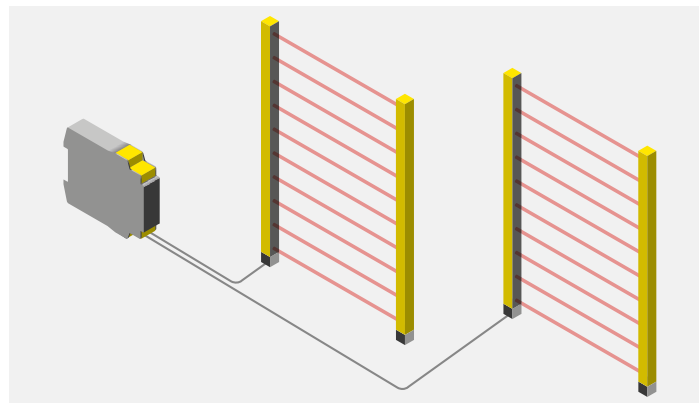

**Solution:** The MSI-SR5B safety relay monitors two safety sensors simultaneously. The common, two-channel shutdown path ensures the safe shutdown of a dangerous movement up to PL e in accordance with ISO 13849-1.

## Evaluation of single light beam safety devices through periodic testing

**Requirement:** Compact single light beam safety devices of type 2 and type 4 in accordance with IEC 61496-1/2 are not generally equipped with internal testing. To satisfy the requirements of electro-sensitive protective equipment, cyclical testing by an external evaluation unit is necessary.

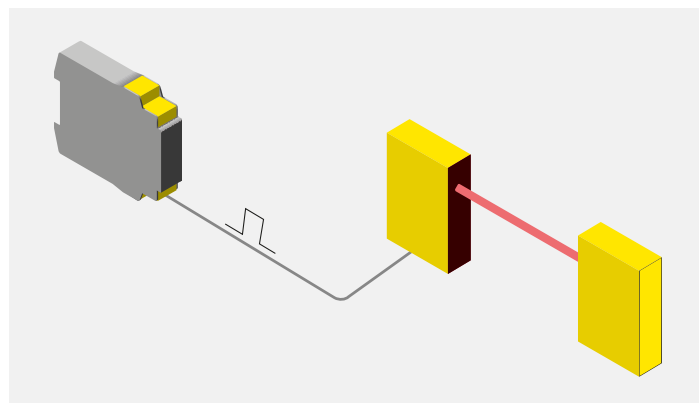

**Solution:** In combination with the type 4 SLS 46C single light beam safety devices, the MSI-TRM evaluation units are already certified as AOPD and achieve PL e in accordance with ISO 13849-1 and SIL<sub>CL</sub>3 in accordance with IEC 62061. The MSI-TR1/TR2 evaluation units are optimized for the evaluation of type 2 single light beam safety devices. PL c and SIL<sub>CL</sub>1 can thereby be achieved.

# Compact design and always suitable

Our MSI safety controls and extension modules provide solutions for a wide variety of different applications.



## You decide which model best suits your task

The safety controllers of the MSI 400 series provide efficient solutions for integrating multiple safety sensors in machines and systems. The compact design and the integrated Ethernet interface save space in the switch cabinet. Due to the high number of inputs, many standard tasks can be solved already with the MSI 410 base module.

In addition, the optional extension modules allow you to adapt the number of inputs and outputs flexibly to your specific requirements.

	MSI 410	MSI 420	MSI 430	
<b>Features</b>	Inputs	20	16	16
	Outputs	4	4	4
	Inputs/outputs, configurable		4	4
	Interfaces	USB mini	USB mini, Ethernet TCP/IP	USB mini, Ethernet TCP/IP
	Fieldbus protocols			Modbus TCP PROFINET IO EtherNet/IP
	I/O extension modules	X	X	X



## Perfect start – modularly expandable

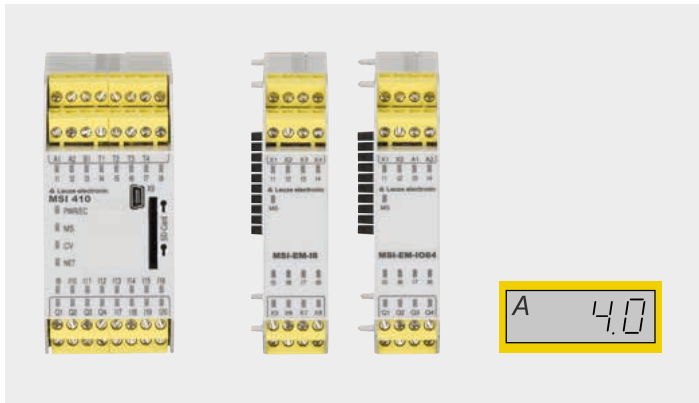

Even the MSI 410 entry-level model features 20 safe inputs and 4 safe outputs, thereby offering the perfect starting point for standard applications. If necessary, all MSI 400 base modules can be expanded with the I/O extension modules to up to 116 safe inputs and 56 safe outputs. Available at each output of the system is 4 A of wear-free switching power. This allows e.g. valves to be actuated directly and makes additional relays unnecessary.

## Integrated gateways

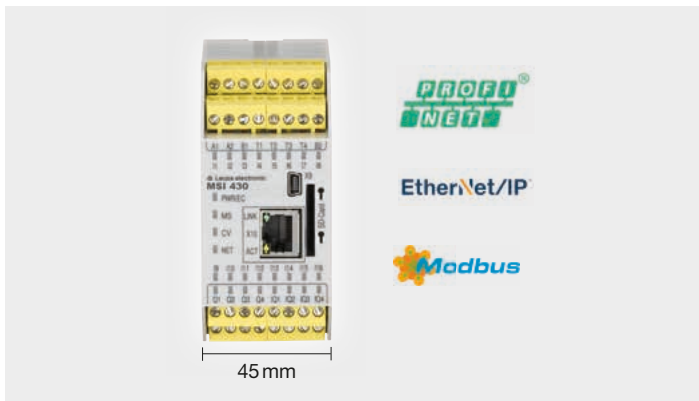

The MSI 400 safety controls can be integrated easily into industrial networks. With a width of just 45 mm, Ethernet interface and Industrial Ethernet protocols are already integrated.

## Gateway modules



Gateway modules are used for integration into other fieldbuses such as EtherCAT, PROFIBUS and CANopen.

## Flexible connection technologies

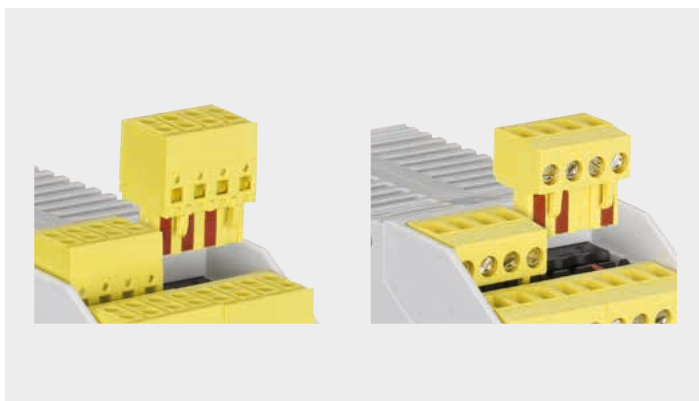

All modules are available with either pluggable screw-type terminals or with spring-force/push-in terminals – this means even better adaptation to your installation requirements.

### Removable program memory



The removable program memory in SD card format, which can be accessed from the front side, provides plenty of space for application programs and comments. This simplifies project handling and reduces the time required for commissioning, duplication and servicing. The cover fastened to the control protects the memory from unintended removal.

### Always quickly connected



Integrated USB and Ethernet interfaces enable flexible access to the system. As a result, status and diagnostic information is available quickly during configuration and operation.

### Optical function indicator via LEDs

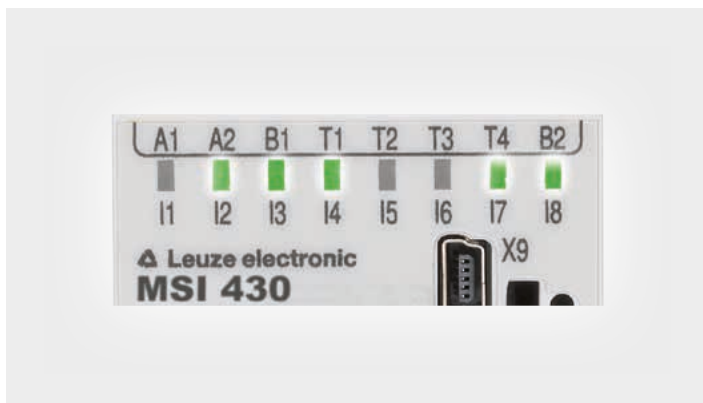

All inputs and outputs of the system feature clearly assigned LED indicators located above the connections. These are supplemented with other LEDs for displaying the module status. As a result, the operating state of a system can be identified quickly and unmistakably.

### Extensive function block library

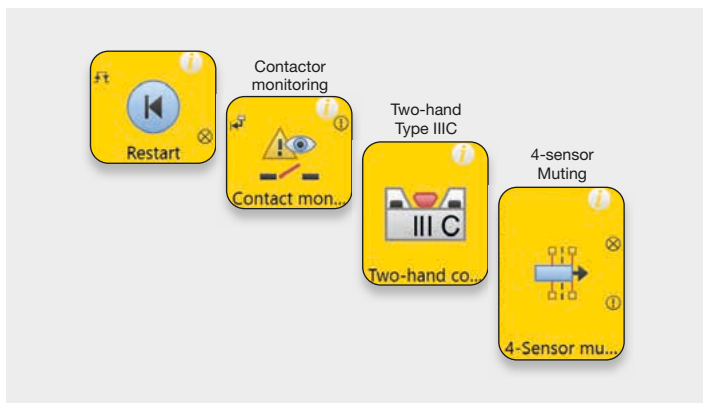

The library of the MSI.designer features more than 50 certified function blocks. Typical functions such as restart, the evaluation of two-hand controls and contactor monitoring as well as complex functions such as muting processes are already pre-configured and can be quickly implemented. Up to 300 function blocks can be integrated in one project.

## Efficient programming is this easy

With the graphical user interface of the MSI.designer software, all MSI devices can be programmed very quickly.



### Reach your goal quickly with simple configuration

With the new MSI.designer configuration tool, you can create projects for the MSI safety controls easily and efficiently. The license-free software supports you during the creation, testing and documentation of projects. For logic programming, an extensive library of certified function blocks is available. These can be arbitrarily arranged on freely definable logic pages by means of drag & drop. In addition, MSI.designer offers a great deal of flexibility for the creation and management of user elements. Programs can be created very quickly through the direct use of sensors and actuators in the logic editor. The assignment to the inputs and outputs of the modules takes place automatically in the background.

In addition to the comfortable simulation on a PC, the MSI 400 also features a force mode, with which you can assign the inputs fixed state values. This enables the targeted testing of processes directly on the machine. As a result, you are ideally prepared for all situations.

- Simple logic configuration
- Simulation and logic analysis for testing the safety function right from a PC
- Force mode for detailed function tests
- Configurable report for professional and well-organized documentation
- Online diagnosis for a fast state overview, including remote maintenance

# Graphic – intuitive – easy

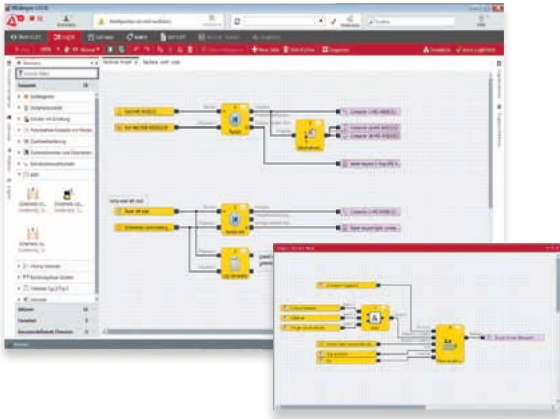

## Intuitive configuration

More than 50 certified function blocks are available for configuring the logic. The intuitive operation allows projects to be set up quickly. The summary of function blocks and arrangement of blocks on freely definable pages ensure a good overview, even with complex projects.

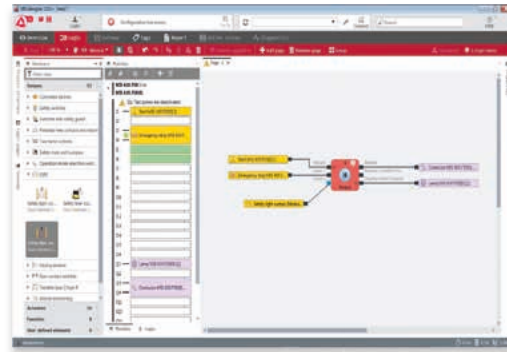

## Create logic quickly

It couldn't be faster: sensors and actuators can be used directly in the logic editor and connected to a function block in the same step. MSI.designer thereby automatically assigns the elements to the inputs and outputs of the modules. If necessary, the assignment can be optimized freely at any time and across modules.

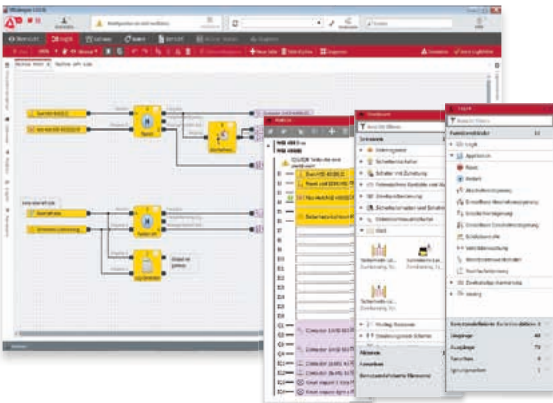

## Freely design views

Everyone works differently. For this reason, MSI.designer offers freely arrangeable windows. Whether across multiple monitors or docked to just one, you always see the elements that optimally support your work. It is even possible to view multiple logic pages in parallel.

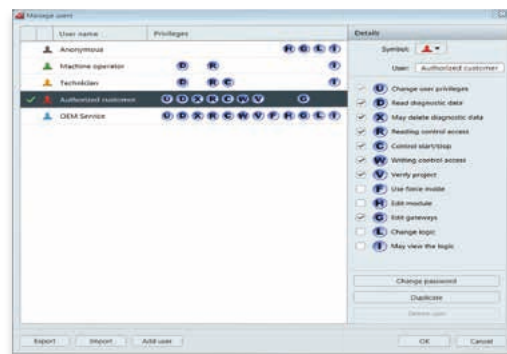

## Protect know-how

Expand the predefined libraries if necessary with application-specific sensors and function blocks. The project and the function blocks can be protected on various levels by means of passwords. With the flexible user management, you can adapt the access rights to the respective user.

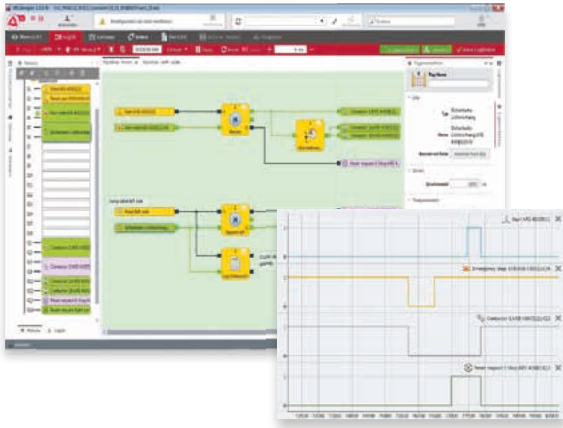

### Integrated simulation

The simulation function and the integrated logic analyzer allow the configured functions to be checked right from a PC. Any necessary modifications are already performed in the office, and not in the installation area on the machine. This saves considerable time during commissioning on site.

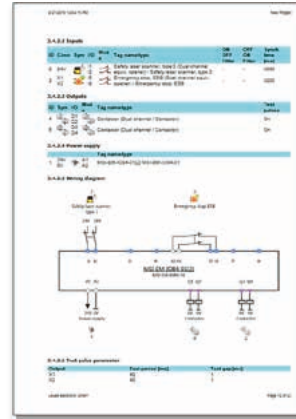

### Professional reports

The documentation function summarizes all project information in a detailed, well-structured report. The report can be configured by the user and thereby provides an important part of the directive-compliant documentation for a machine at the press of a button.

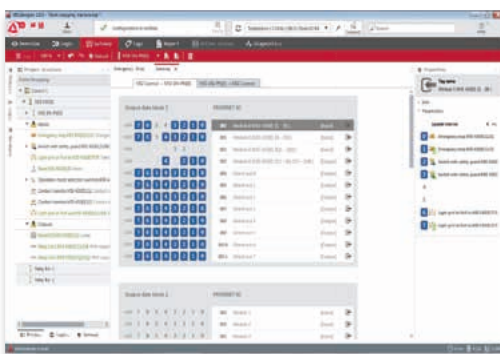

### Transfer important data

All industrial Ethernet and fieldbus protocols are easy to use thanks to the comfortable configuration.

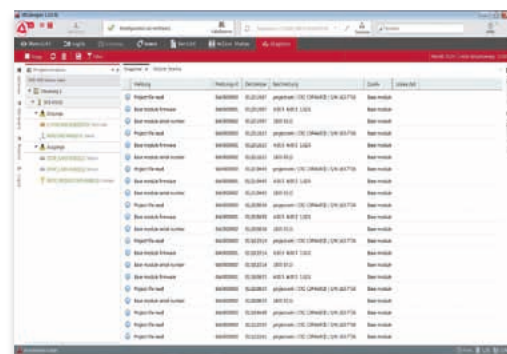

### Fast online diagnosis

The integrated online diagnosis and the system logbook provide a quick overview of the system status. Possible problems can thereby be quickly localized. Solutions for remote maintenance can also be implemented without additional effort, thereby often eliminating the need for expensive maintenance work.



# Base modules, gateways and I/O extensions



MSI 410

MSI 420

MSI 430

	MSI 410	MSI 420	MSI 430
<b>Device type / function</b>	Safety control	Safety control	Safety control
<b>Inputs/outputs</b>	20 inputs/4 outputs	16 inputs/4 outputs/ 4 configurable I/Os	16 inputs/4 outputs/ 4 configurable I/Os
<b>Test outputs</b>	4 (4 test signal generators)	4 (4 test signal generators)	4 (4 test signal generators)
<b>Cat. / Performance Level</b> (EN ISO 13849-1)	4 / PL e	4 / PL e	4 / PL e
<b>Safety Integrity Level</b> (IEC 61508/EN IEC 62061)	SIL 3 / SIL <sub>CL</sub> 3	SIL 3 / SIL <sub>CL</sub> 3	SIL 3 / SIL <sub>CL</sub> 3
<b>Interfaces</b>	USB mini	USB mini, Ethernet TCP/IP	USB mini, Ethernet TCP/IP
<b>Fieldbus protocols</b>	–	–	Modbus TCP PROFINET IO EtherNet/IP
<b>Interface functionality</b>	Configuration Diagnostics via PC	Configuration Diagnostics via PC Diagnostics via PLC	Configuration Diagnostics via PC Diagnostics via PLC Gateway functionality
<b>Maximum number of extension modules/gateways</b>	12 I/O extensions 2 gateways	12 I/O extensions 2 gateways	12 I/O extensions 2 gateways
<b>Configuration</b>	MSI.designer configuration software, license-free	MSI.designer configuration software, license-free	MSI.designer configuration software, license-free
<b>Function blocks</b>	300 blocks per project, free assignment	300 blocks per project, free assignment	300 blocks per project, free assignment
<b>Program memory</b>	Exchangeable, SD card format, 512 MB	Exchangeable, SD card format, 512 MB	Exchangeable, SD card format, 512 MB
<b>Function indicator</b>	24 green LEDs (1 × per I/O) 4 LEDs - green / red / yellow for module status	24 green LEDs (1 × per I/O) 4 LEDs - green / red / yellow for module status	24 green LEDs (1 × per I/O) 4 LEDs - green / red / yellow for module status
<b>Maximum switching power per output</b>	4 A, short-circuit proof	4 A, short-circuit proof	4 A, short-circuit proof
<b>Supply voltage</b>	24 VDC (16.8 ... 30 VDC)	24 VDC (16.8 ... 30 VDC)	24 VDC (16.8 ... 30 VDC)
<b>Power consumption</b>	3.5 W	3.5 W	3.5 W
<b>Dimensions</b> (W × H × L)	45 × 96 × 115 mm	45 × 96 × 115 mm	45 × 96 × 115 mm
<b>Ambient temperature</b>	–25 ... +65 °C	–25 ... +65 °C	–25 ... +65 °C
<b>Certifications</b>	TÜV, cUL <sub>US</sub>	TÜV, cUL <sub>US</sub>	cUL <sub>US</sub>



MSI-FB-ETHERCAT



MSI-FB-PROFIBUS



MSI-FB-CANOPEN

	MSI-FB-ETHERCAT	MSI-FB-PROFIBUS	MSI-FB-CANOPEN
<b>Device type / function</b>	Gateway	Gateway	Gateway
<b>Interfaces</b>	2 × RJ45 sockets	1 × RS485 (Sub-D, 9-pin)	Screw terminals, 5-pin
<b>Fieldbus protocols</b>	EtherCAT	PROFIBUS DP	CANopen
<b>Data transmission rate</b>	100 Mbit/s	12 Mbit/s	Up to 1 Mbit/s
<b>Function indicators</b>	5 LEDs	3 LEDs	3 LEDs
<b>Supply voltage</b>	24 VDC (16.8 ... 30 VDC)	24 VDC (16.8 ... 30 VDC)	24 VDC (16.8 ... 30 VDC)
<b>Power consumption</b>	Max. 2.4 W	Max. 2.4 W	Max. 2.4 W
<b>Dimensions (W × H × L)</b>	22.5 × 96.5 × 121 mm	22.5 × 96.5 × 121 mm	22.5 × 96.5 × 121 mm
<b>Ambient temperature, operation</b>	-25 ... +55 °C	-25 ... +55 °C	-25 ... +55 °C



MSI-EM-I8



MSI-EM-I084



MSI-EM-I084NP

	MSI-EM-I8	MSI-EM-I084	MSI-EM-I084NP
<b>Device type / function</b>	Safe extension module	Safe extension module	Non-safe extension module
<b>Inputs/outputs</b>	8 inputs	8 inputs/4 outputs	4 inputs/4 outputs/ 4 configurable I/Os
<b>Test outputs</b>	8 (2 test signal generators)	2 (2 test signal generators)	–
<b>Cat. / Performance Level</b>	4 / PL e	4 / PL e	–
<b>Safety Integrity Level</b>	SIL 3 / SIL <sub>CL</sub>	SIL 3 / SIL <sub>CL</sub>	–
<b>Function indicator</b>	8 green LEDs (1 × per I) 1 LED for module status	12 green LEDs (1 × per I/O) 1 LED for module status	12 green LEDs (1 × per I/O) 1 LED for module status
<b>Maximum switching power per output</b>	–	4 A	0.5 A
<b>Supply voltage</b>	24 VDC (16.8 ... 30 VDC)	24 VDC (16.8 ... 30 VDC)	24 VDC (16.8 ... 30 VDC)
<b>Power consumption</b>	Max. 1.4 W	Max. 1.1 W	Max. 0.5 W
<b>Dimensions (W × H × L)</b>	22.5 × 93.7 × 120.8 mm	22.5 × 93.7 × 120.8 mm	22.5 × 93.7 × 120.8 mm
<b>Ambient temperature, operation</b>	-25 ... +65 °C	-25 ... +65 °C	-25 ... +65 °C
<b>Certifications</b>	TÜV, cUL <sub>US</sub>	TÜV, cUL <sub>US</sub>	TÜV, cUL <sub>US</sub>

# Compact safety for your application

Our comprehensive safety relay portfolio always offers the right suitable link between safety device and machine.



## Compact and safe

The compact and reliable safety relays offer the right solution for the rapid integration of individual safety sensors into the safety circuit of machines and systems solution. Applications range from monitoring simple components such as EMERGENCY STOP or safety switches to integrating optoelectronic sensors and implementing time-delayed applications.

All relays are optionally available with pluggable screw or spring-loaded terminals. This means flexibility for the user during installation and enables quick replacement in case of service.

## Evaluation units

The portfolio includes both evaluation units tailored to different sensor types and technologies and evaluation units for universal use. Variants with time delays of up to 3 seconds and up to 30 seconds are used for applications with stop category 1.

## Contact expander relays

The contact expansion relays are suitable both as simple output expansions for OSSDs and for contact multiplication for evaluation units or safety controllers.

## Safe shutdown of a drive

The safety function ensures that the drive is switched off safely at all times. Drive at any time – when the sensor is triggered and when a fault is detected.

Generally speaking, the safety-related part of a control system according to ISO 13849-1 (SRP/CS – Safety Related Part of Control System) is the necessary central component for the execution of a safety function. It evaluates the signals coming from the sensor, detects cross circuits on the sensor side as well as faults in the contactor and ensures that the drive is switched off safely. A safety sensor alone cannot fulfill these tasks – rather, safety sensors are always part of a safety function. In the simplest case, a classic safety relay takes over the necessary tasks.



The safety function is usually triggered by a person, e.g. by interrupting a safety light curtain or activating a safety switch when opening a door or flap. The safety relay detects the signals coming from the sensor and disconnects the supply voltage to the contactor via its switch-off paths – and the contactor disconnects the energy supply to the drive.

### Monitoring functions of a Safety relay

#### Evaluation of the sensor outputs

For sensors with electro-mechanical contacts, cross-circuit detection by the safety relay is necessary.

#### EDM monitoring of external devices

The EDM function monitors the correct function of the contactor. This means that sticking of the switching contacts can be detected before a dangerous situation occurs. Without using the EDM function, maximum of performance level c can be achieved.



### Design of the safety function with a safety relay





#### Preventing an automatic restart

If an undetected stay of a person is possible in the area behind an access guarding, the machine must not be restarted automatically. In this case, the safety relay takes over the monitoring of a manual reset command.











#### Use of the shutdown paths





Safety relays offer several shutdown paths, the use of which has a direct influence on the achievable performance level (PL). With 1-channel use, a maximum of PL c can be achieved, with 2-channel use PL e.

# The right safety relay at a glance

Sensor		Relay						Product
Type	Outputs	Restart Manual / automatic	Contacts NO contact / NC contact	Release time $t_R$	Switching current	Performance Level / category		
	- 2-hand control device type III C	2x 1 NC/1 NO	M / A	2 / 1	50 ms	6 A	PL e / 4	<b>MSI-SR-2H21</b>
	- E-Stop button - Safety switches	1 NC or 2 NC	M / A	3 / 1	60 ms	8 A	PL d / 3	<b>MSI-SR-ES31</b>
			M / A	2 / 1	25 ms	6 A	PL e / 4	<b>MSI-SR-LC21</b>
			- / A	3 / 1	10 ms	8 A	PL e / 4	<b>MSI-SR-LC31AR</b>
			M / -	3 / 1	10 ms	8 A	PL e / 4	<b>MSI-SR-LC31MR</b>
		1 NC / 1 NO	M / A	2 / 1	20 ms	3 A	PL e / 4	<b>MSI-MC310</b>
		2 NC	M / A	3 / 1	10 ms	3 A	PL e / 4	<b>MSI-SR4</b>
		2x 2 NC	M / A	2 / 0	10 ms	2 A	PL e / 4	<b>MSI-SR5</b>
	- Safety proximity sensors (magnetic)	2 NC	M / A	2 / 1	25 ms	6 A	PL e / 4	<b>MSI-SR-LC21</b>
			- / A	3 / 1	10 ms	8 A	PL e / 4	<b>MSI-SR-LC31AR</b>
			M / -	3 / 1	10 ms	8 A	PL e / 4	<b>MSI-SR-LC31MR</b>
			M / A	3 / 1	10 ms	3 A	PL e / 4	<b>MSI-SR4</b>
		1 NC and 1 NO	M / A	2 / 1	20 ms	3 A	PL e / 4	<b>MSI-MC310</b>
	- Safety sensors with electronic out- puts (OSSD): - Safety light curtains - Safety laser scanners - Safety switches, e.g. with RFID technology	2 OSSDs	M / A	2 / 1	25 ms	6 A	PL e / 4	<b>MSI-SR-LC21</b>
			- / A	3 / 1	10 ms	8 A	PL e / 4	<b>MSI-SR-LC31AR</b>
			M / -	3 / 1	10 ms	8 A	PL e / 4	<b>MSI-SR-LC31MR</b>
			M / A	3 / 1	10 ms	3 A	PL e / 4	<b>MSI-SR4</b>
		2x 2 OSSDs	M / A	2 / 0	10 ms	2 A	PL e / 4	<b>MSI-SR5</b>

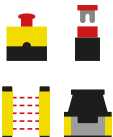
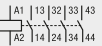
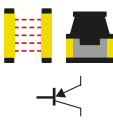

 Two-hand control	 Safety solenoid switches	 Safety switches with electr. outputs (OSSDs)	 Restart automatic/manual
 E-Stop	 Protective sensors / safety light curtains	 Type 2 safety sensor, testable	 Time delay
 Safety switches and safety locking devices	 Safety laser scanners	 Type 4 safety sensor, testable	

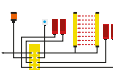
Sensor / application		Relay / contact extension				
Type	Outputs	Restart Manual / automatic	Contacts NO contact / NC contact	Additional functions	Performance Level / category	Product
<b>Evaluation units with time function</b>						
 <ul style="list-style-type: none"> <li>- E-Stop</li> <li>- Safety switches</li> <li>- Safety light curtains</li> <li>- Safety laser scanners</li> </ul>	2 NC or 2 OSSDs	M / A	2 / -	1 delayed contact 0,15 – 3 sec., PL d	PL e / 4	MSI-SR-LC21DT03
		M / A	2 / -	1 delayed contact 1,5 – 30 sec., PL d	PL e / 4	MSI-SR-LC21DT30
 <b>Contact extensions</b>						
 <ul style="list-style-type: none"> <li>- Safety light curtains</li> <li>- Safety laser scanners</li> <li>- Safety switches (e.g. with RFID technology)</li> </ul>	2 OSSDs	- / A	2 / 1		PL e / 4	MSI-RM2
		- / A	3 / 2		PL e / 4	MSI-SR-CM32
 <ul style="list-style-type: none"> <li>- Safety relays</li> <li>- Safety control</li> </ul>	Relay output or PNP output	- / A	4 / 3		PL d / 3	MSI-SR-CM43
		- / A	5 / 2		PL e / 4	MSI-CM52
		- / A	2x (2/1)		PL e / 4	MSI-SR-CM42R
<b>Evaluation units for periodic testing</b>						
 <ul style="list-style-type: none"> <li>- Type 2 safety sensor, testable</li> </ul>	PNP output	M / A	2 / 2		PL c / 2	MSI-TR1
		M / A	2 / 2	Filter time 130 ms	PL c / 2	MSI-TR2
 <ul style="list-style-type: none"> <li>- SLS 46C: Type 4 safety sensor, testable</li> </ul>	PNP output	M / A	2 / 2		PL e / 4	MSI-TRM
<b>Muting controller (field module)</b>						
 <ul style="list-style-type: none"> <li>- Protective sensors, muting sensors, diffuse sensors, ...</li> </ul>	-	M / -	OSSD outputs	Control of muting processes	PL e / 4	MSI-MD-FB

# Evaluation units



**MSI-SR-ES31**

**MSI-MC310**

**MSI-SR-2H21**

	MSI-SR-ES31	MSI-MC310	MSI-SR-2H21	
<b>General</b>	<b>Device type/function</b>	Evaluation unit	Evaluation unit	
	<b>Sensors/application</b>	E-STOP Safety switches with relay contacts	Safety solenoid switches	Two-hand control devices (type III C, EN 574)
	<b>Special function</b>	–	–	–
<b>Specifications</b>	<b>Cat./Performance Level</b> (EN ISO 13849-1)	3/PL d	4/PL e	4/PL e
	<b>Safety Integrity Level</b> (IEC 61508/EN IEC 62061)	SIL 2/SIL <sub>CL</sub> 2	–	SIL 3/SIL <sub>CL</sub> 3
	<b>Number of release contacts</b> (NO contact)	3	2	2
	<b>Number of signal contacts</b> (NC contact)	1	1	1
	<b>Inputs/actuation</b>	1- or 2-channel	1 NC contact, 1 NO contact	2-channel (1 NC and 1 NO per channel)
	<b>Start, restart</b>	Automatic, manual	Automatic, manual	Through synchronous actuation
	<b>Contact monitoring (EDM)</b>	X	X	X
	<b>Function indicator</b>	2 LEDs	3 LEDs	3 LEDs
	<b>Regression delay</b>	60 ms	20 ms	50 ms
	<b>Max. continuous current per path</b>	8 A	3 A	6 A
	<b>Mechanical life time</b>	1 × 10 <sup>7</sup>	1 × 10 <sup>7</sup>	1 × 10 <sup>7</sup>
	<b>Ambient temperature, operation</b>	–25 ... +55 °C	0 ... +55 °C	–25 ... +55 °C
	<b>Dimensions with screw terminals</b> (W × H × L)	96.5 × 22.5 × 107.6 mm	99.5 × 22.5 × 113.6 mm	96.5 × 22.5 × 114 mm
<b>Certifications</b>	TÜV, C UL <sub>US</sub>	TÜV, C UL <sub>US</sub>	TÜV, C UL <sub>US</sub>	
<b>Functions overview</b>				



**MSI-SR-LC21**

**MSI-SR-LC31AR  
MSI-SR-LC31MR**

**MSI-SR4B**

**MSI-SR5B**

Evaluation unit	Evaluation unit	Evaluation unit	Evaluation unit
E-STOP safety switches: - with relay contacts - with OSSD outputs - with magnetic contacts Safety light barriers Safety laser scanners	E-STOP safety switches: - with relay contacts - with OSSD outputs - with magnetic contacts Safety light barriers Safety laser scanners	E-STOP safety switches: - with relay contacts - with OSSD outputs - with magnetic contacts Safety light barriers Safety laser scanners	E-STOP safety switches: - with relay contacts - with OSSD outputs - with magnetic contacts Safety light barriers Safety laser scanners
-	-	-	Parallel evaluation of 2 sensors
4 / PL e	4 / PL e	4 / PL e	4 / PL e
SIL 3 / SIL <sub>CL</sub> 3	SIL 3 / SIL <sub>CL</sub> 3	SIL 3 / SIL <sub>CL</sub> 3	SIL 3 / SIL <sub>CL</sub> 3
2	3	3	2
1	1	1	-
1- or 2-channel	1- or 2-channel	1- or 2-channel	2 × (1- or 2-channel)
Automatic, manual	Automatic (AR), manual (MR)	Automatic, manual	Automatic, manual
X	X	X	X
3 LEDs	3 LEDs	4 LEDs	4 LEDs
25 ms	10 ms	10 ms	10 ms
6 A	8 A	3 A	2 A
1 × 10 <sup>7</sup>	1 × 10 <sup>7</sup>	1 × 10 <sup>7</sup>	1 × 10 <sup>7</sup>
-25 ... +55 °C	-25 ... +55 °C	0 ... +55 °C	0 ... +55 °C
99.5 × 22.5 × 114 mm	96.5 × 22.5 × 114 mm	99.5 × 22.5 × 111.5 mm	99.5 × 22.5 × 111.5 mm
TÜV, C <sub>UL</sub> <sub>US</sub>	TÜV, C <sub>UL</sub> <sub>US</sub>	TÜV, C <sub>UL</sub> <sub>US</sub>	TÜV, C <sub>UL</sub> <sub>US</sub>

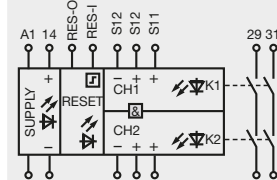
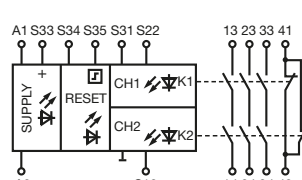
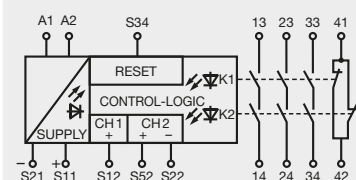
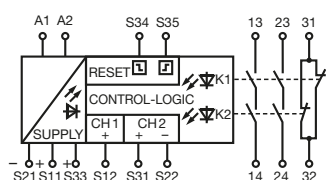

# Evaluation units / with time function, output extensions for OSSDs, contact extensions



**MSI-SR-LC21DT03**  
**MSI-SR-LC21DT30**

**MSI-DT30B**

**MSI-RM2B**

General	Device type/function	Evaluation unit with time delay	Evaluation unit with time delay	Evaluation unit
	Sensors/application	E-STOP safety switches: – with relay contacts – with OSSD outputs Safety light barriers Safety laser scanners	E-STOP safety switches: – with relay contacts – with OSSD outputs Safety light barriers Safety laser scanners	Safety light barriers Safety laser scanner Safety switch: – with OSSD outputs
	Special function	Delay: 0.15– 3 s (DT03) Delay: 1.5– 30 s (DT30)	Delay: 0.1– 30 s	–
Specifications	Cat. / Performance Level (EN ISO 13849-1)	4/PL e (3/PL d for delayed contact)	4/PL e	4/PL e
Safety Integrity Level (IEC 61508/EN IEC 62061)	SIL 3/SIL <sub>CL</sub> 3 (2/SIL <sub>CL</sub> 2 for delayed contact)	SIL 3/SIL <sub>CL</sub> 3	SIL 3/SIL <sub>CL</sub> 3	
Number of release contacts (NO contact)	2 + 1 delayed	2 + 2 delayed	2 (change-over contact)	
Number of signal contacts (NC contact)	–	–	1	
Inputs/actuation	1- or 2-channel	1- or 2-channel	2-channel OSSDs	
Start, restart	Automatic, manual	Automatic, manual	Automatic	
Contactor monitoring (EDM)	X	X	X	
Function indicator	3 LEDs	3 LEDs	2 LEDs	
Regression delay	25 ms	20 ms	10 ms	
Max. continuous current per path	6 A	6 A	3 A	
Mechanical life time	1 × 10 <sup>7</sup>	1 × 10 <sup>7</sup>	1 × 10 <sup>7</sup>	
Ambient temperature, operation	–25 ... +55 °C	–20 ... +55 °C	0 ... +50 °C	
Dimensions with screw terminals (W × H × L)	96.5 × 22.5 × 114 mm	99.5 × 22.5 × 111.5 mm	99 × 17.5 × 111.5 mm	
Certifications	TÜV, <sub>C</sub> UL <sub>US</sub>	TÜV, <sub>C</sub> UL <sub>US</sub>	TÜV, <sub>C</sub> UL <sub>US</sub>	
Functions	<p><b>Functions overview</b></p>			



**MSI-SR-CM42R**

**MSI-SR-CM43**

**MSI-SR-CM32**

**MSI-CM52B**

Contact extension	Contact extension	Evaluation unit	Contact extension
Extension for safety relays and safety PLCs	Extension for safety relays and safety PLCs	Safety light barriers Safety laser scanner Safety switch: – with OSSD outputs	Extension for safety relays and safety PLCs
2 extensions in one device	–	–	–
4/PL e	3/PL d	4/PL e	4/PL e
SIL 3/SIL <sub>CL</sub> 3	SIL 2/SIL <sub>CL</sub> 2	SIL 3/SIL <sub>CL</sub> 3	SIL 3/SIL <sub>CL</sub> 3
2 × 2	4	3	5
2 × 1	3	2	2
1- or 2-channel	1- or 2-channel	2-channel OSSDs	1- or 2-channel
Automatic	Automatic	Automatic	Automatic
–	–	X	–
2 LEDs	2 LEDs	2 LEDs	1 LED
15 ms	40 ms	20 ms	20 ms
6 A	2 A	6 A	6 A
1 × 10 <sup>7</sup>	1 × 10 <sup>7</sup>	1 × 10 <sup>7</sup>	1 × 10 <sup>7</sup>
–25 ... +65 °C	–25 ... +55 °C	–25 ... +55 °C	–20 ... +55 °C
96.5 × 22.5 × 114 mm	96.5 × 22.5 × 114 mm	96.5 × 22.5 × 114 mm	99.5 × 22.5 × 114.5 mm
TÜV, UL <sub>US</sub>	TÜV, UL <sub>US</sub>	TÜV, UL <sub>US</sub>	TÜV, UL <sub>US</sub>

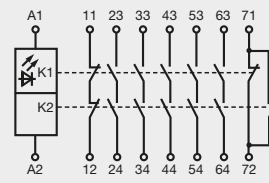
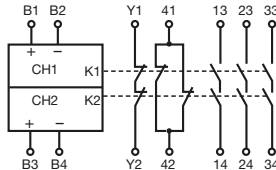
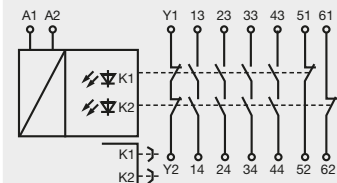
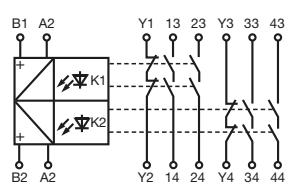



# Evaluation units for periodic testing



**MSI-TR1B  
MSI-TR2B**

**MSI-TRMB**

<b>General</b>	<b>Device type / function</b>	Evaluation unit for periodic testing	Evaluation unit for periodic testing
	<b>Sensors / application</b>	Testable optoelectronic protective devices of type 2	Testable optoelectronic protective devices of type 4
	<b>Special function</b>	– (TR1B) Filter time 130 ms (TR2B)	–
<b>Specifications</b>	<b>Cat. / Performance Level</b> (EN ISO 13849-1)	2 / PL e	4 / PL e
	<b>Safety Integrity Level</b> (IEC 61508/EN IEC 62061)	SIL 1 / SIL <sub>CL</sub> 1	SIL 3 / SIL <sub>CL</sub> 3
	<b>Number of release contacts</b> (NO contact)	2	2
	<b>Number of signal contacts</b> (NC contact)	2 (semiconductor)	2 (semiconductor)
	<b>Inputs / actuation</b>	1 or 2 input circuits, up to 3 sensors each	1 or 2 input circuits, up to 3 sensors each
	<b>Start, restart</b>	Automatic, manual	Automatic, manual
	<b>Contactor monitoring (EDM)</b>	X	X
	<b>Function indicator</b>	4 LEDs	6 LEDs
	<b>Regression delay</b>	20 ms	130 ms
	<b>Max. continuous current per path</b>	2 A	3 A
	<b>Mechanical life time</b>	1 × 10 <sup>7</sup>	1 × 10 <sup>7</sup>
	<b>Ambient temperature, operation</b>	–30 ... +60 °C	–25 ... +55 °C
	<b>Dimensions with screw terminals</b> (W × H × L)	99 × 22.5 × 111.5 mm	99 × 22.5 × 111.5 mm
<b>Certifications</b>	TÜV, <sub>C</sub> UL <sub>US</sub>	TÜV (in combination with SLS 46C)	
<b>Functions</b>	<b>Functions overview</b>		

# MSI-MD-FB

## Muting interface



### Areas of application

- Access guarding on conveyor lines with muting function

The MSI-MD-FB muting interface provides extensive muting functions in combination with the standard variants of the ELC and MLC safety light curtains as well as the MLD multiple light beam safety devices. As a field module, it is installed close to the protective device and combines all the necessary connections for sensors, muting indicators and reset buttons. Three muting operating modes and other detailed functions ensure optimal adaptation to the application. If short safety distances are necessary, the MSI-MD-FB, in combination with the ELC and MLC safety light curtains, offers a flexible muting solution.

### Advantages for you

- Configurable muting functions to allow flexible adaptation to the application
- The interface can be configured easily and without PC using the concealed DIP switches
- By using the muting interface, the same safety sensor model can be used in applications with and without muting. The variety of types is thereby reduced.

### Functions overview

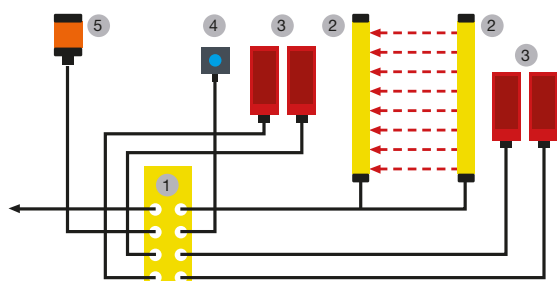

1 muting controller, 2 safety sensors, 3 muting sensors, 4 acknowledgment units, 5 muting indicators

### MSI-MD-FB

MSI-MD-FB		
Features	Muting interface for muting applications in combination with standard variants of the MLC and ELC safety light curtains and MLD multiple light beam safety devices	
	Muting operating modes: 2-sensor time-controlled, 2- and 4-sensor sequence controlled	
	Input signal 'muting enable'	
	Selectable muting timeout times: 20 sec., 2 min., 10 min., 100 hrs.	
	M12 connector, 5 and 8-pin	
Wide temperature range from -30 ... 60°C, degree of protection IP 67		
Specifications	Cat./Performance Level (EN ISO 13849-1)	4 / PL e
	Safety Integrity Level (IEC 61508 / EN IEC 62061)	SIL 3 / SIL <sub>CL</sub> 3
	Output	OSSD pair
	Inputs	Light barriers, muting sensors
	Start, restart	Manual
	Function indicator	7 segment, LEDs
	Ambient temperature, operation	-30 ... +60°C
	Dimensions	225 × 60 × 37 mm
Certifications	TÜV	

# Machine Safety Services

Sustainable machine safety begins with professional planning of the safety systems and spans the entire lifecycle of a machine. Our teams of experienced and certified experts offer the appropriate support here.

## Stages of a machine life cycle

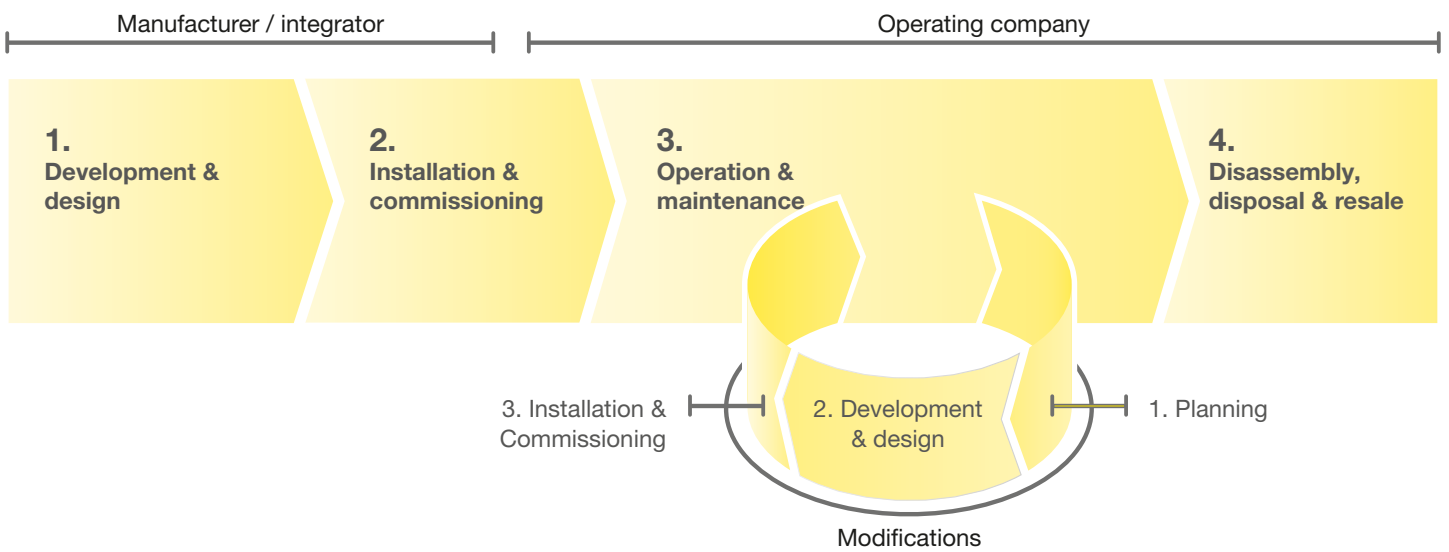

When designing and constructing machines, we create the safety-related concept together with you and support you in its realization. During operation, we regularly perform tests to ensure the permanent function of the safety systems. If changes are made to existing machines, we provide you with support on everything from the safety-related planning to renewed commissioning.

Through our services, you benefit from our many years of experience in the area of machine safety and our extensive industry and application knowledge. Efficient safety-related solutions for every phase of a machine's life cycle are thereby created together.

## Our service offerings



### Status check 'safety technology on machines and systems'

- Our experts analyze the safety-related condition of your machinery and check whether the current safety-related requirements are satisfied in accordance with the current state of the art.
- In the event of deviations, we provide recommendations on what corrections can be performed so as to comply with legal requirements.



### Risk assessment and hazard assessment

In accordance with applicable directives, the manufacturer of a machine is required to perform a risk assessment. This also applies in the case of significant modifications or extensions of machines.

The national regulations for the operation of machines require employers to conduct a hazard assessment before using work equipment and to update this assessment at regular intervals according to the current state of the art.

- Our experts support you in identifying the dangers, in assessing and evaluating the risks as well as in defining the risk-reducing measures.



### Inspection of protective devices

- Within the scope of the initial or regular inspection, we check the condition, mounting and correct function of the protective device as well as the correct integration in the safe part of the machine control
- We summarize the results of the tests in a detailed report.  
If necessary, this includes practically oriented suggestions on how deviations can be corrected.



### Stopping time measurement

For the correct placement of the protective device, the required minimum distance between protective device and dangerous movements is to be calculated. To do this, the stopping time of the machine must be known. With the stopping time measurement, we determine this value reliably.

- By measuring the stopping time within the scope of regular inspections, any wear, such in brake components, can be detected in good time.



### Status check: 'CE marking of machines'

During the development of machines, the specifications from the machinery directive must be adhered to and documented by the manufacturer. This is confirmed with the Declaration of Conformity and the CE marking.

- We check the documentation for completeness and give recommendations of how any deviations can be corrected.

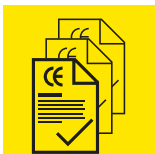

### Conformity assessment in accordance with the European machinery directive

The machinery directive defines the procedure for the design and construction of machines for satisfying the applicable safety and health protection requirements. This is a prerequisite for the Declaration of Conformity and the CE marking.

- We help you comply with and implement the legal requirements of the machinery directive.



### Safety concept and safety design

The measures necessary for risk minimization are known from the risk analysis.

The safety concept and the safety functions are developed on the basis of these requirements.

- With our extensive industry knowledge and our many years of safety-related experience, we create practically oriented concept proposals for you and support you during their implementation.



### Verification and validation

To avoid errors during the implementation of safety functions, both the hardware as well as the software must be checked to determine whether the requirements of the functional specification were met completely and correctly. The function test of all safety functions is to be performed according to the validation plan.

- We support you during the planning, development and execution of the function tests as well as with the creation of the required documentation.

# Safety from a single source

Individual requirements need flexible solutions. Our high-quality products and intelligent systems as well as competent technical services and support form the basis of our safety portfolio. Benefit from our extensive range of products. The diversity of our portfolio means that we are able to provide you with all components, from sensor to control, from a single source – all with maximum user-friendliness and all optimally matched to each other.

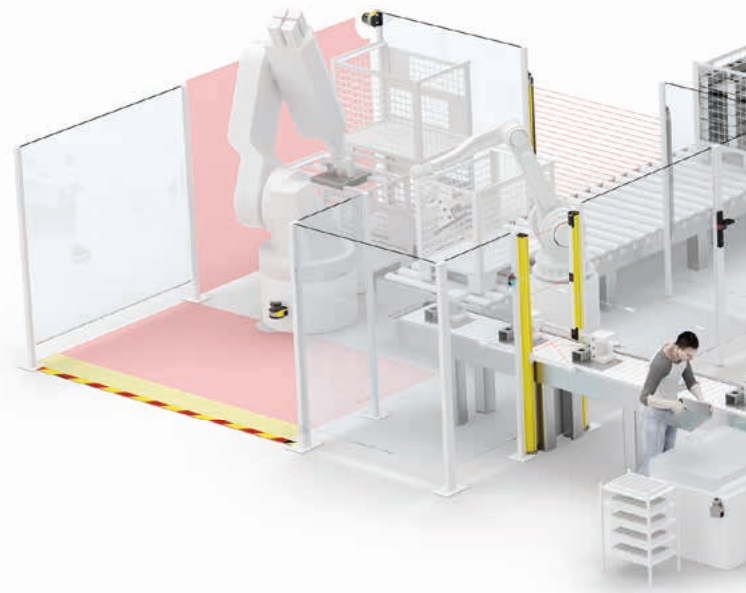

## Products



**Safety laser scanner**



**Safety light curtains / with Smart Process Gating**



**Multiple light beam safety devices / with muting**



**Single light beam safety devices**



**Safety radar sensors**



**Safety switches**



**Safety proximity sensors**



**Safety switches with guard locking**



**Safety controls and relays**



**Safety command devices**



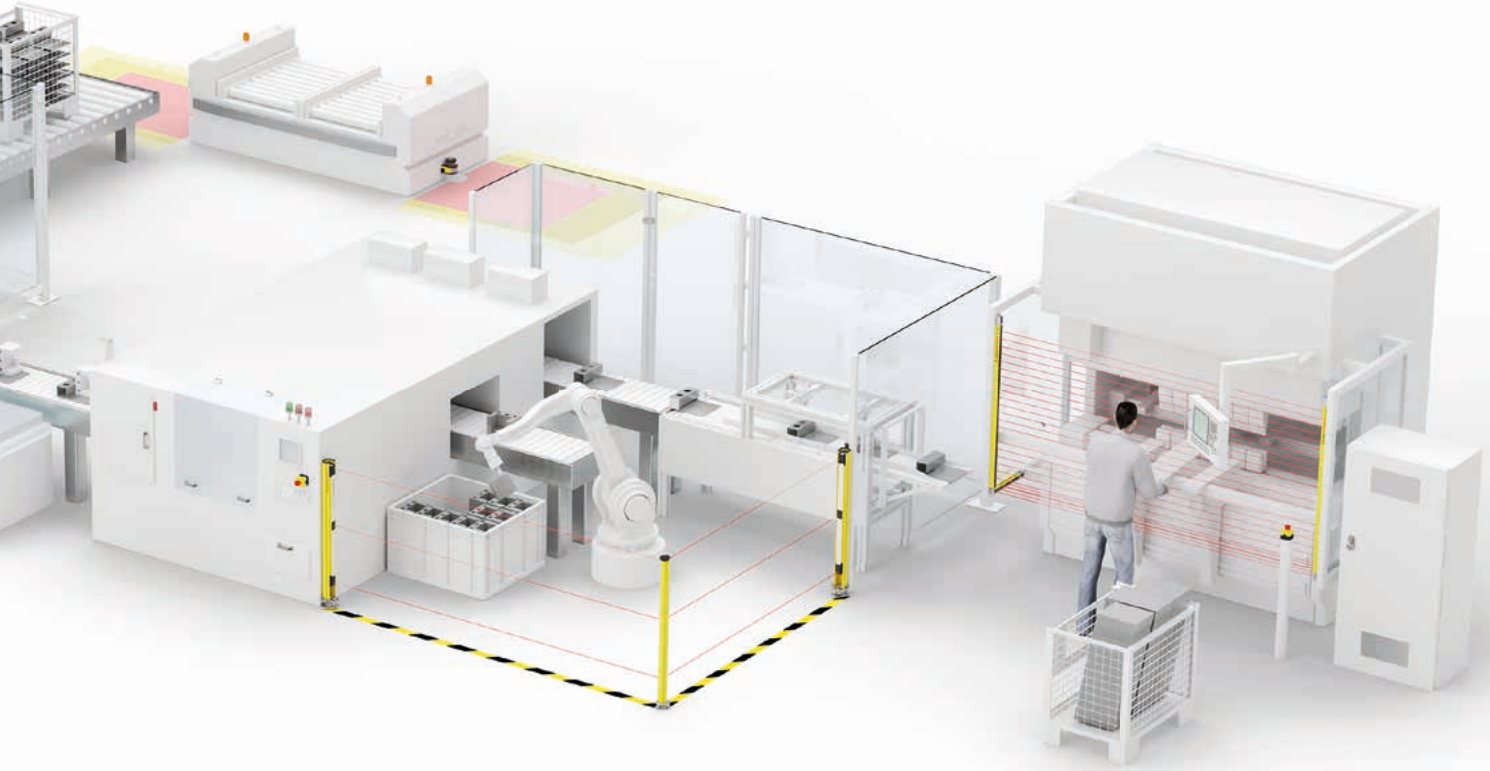

# Solutions

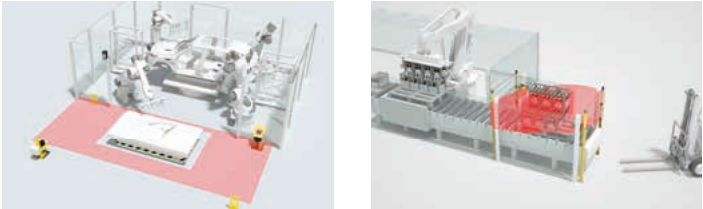

Safety solutions, e.g. for guarding transfer stations

# Services



Safety services, e.g. inspections, risk analysis and validation

# Our company

## Everything at a glance

In a constantly changing industrial world, we work together with our customers to find the best solution for their sensor applications: innovatively, precisely and efficiently.

### Key figures

<b>Foundation</b>	1963
<b>Company structure</b>	GmbH + Co. KG, wholly family-owned
<b>Executive management</b>	Ulrich Balbach
<b>Headquarters</b>	Owen, Germany
<b>Distribution companies</b>	21
<b>Production locations</b>	6
<b>Technological competence centers</b>	3
<b>Distributors</b>	40
<b>Employees</b>	> 1,200

### Product range

- Switching sensors
- Measuring sensors
- Safety
- Identification
- Data transmission
- Network and connection technology
- Industrial image processing
- Accessories and supplementary products

### Focus industries

- Intralogistics
- Packaging industry
- Machine tools
- Automotive industry
- Laboratory automation



### Leuze electronic GmbH + Co. KG

In der Braike 1  
73277 Owen  
Phone: +49 7021 573-0  
Fax: +49 7021 573-199  
E-mail: [info@leuze.com](mailto:info@leuze.com)  
[www.leuze.com](http://www.leuze.com)





# Our Locations

## At work for you around the world

Your success is our motivation. We therefore place great value on always being personally, quickly, and easily accessible to you. We produce on four continents, allowing us to offer you reliable product availability.

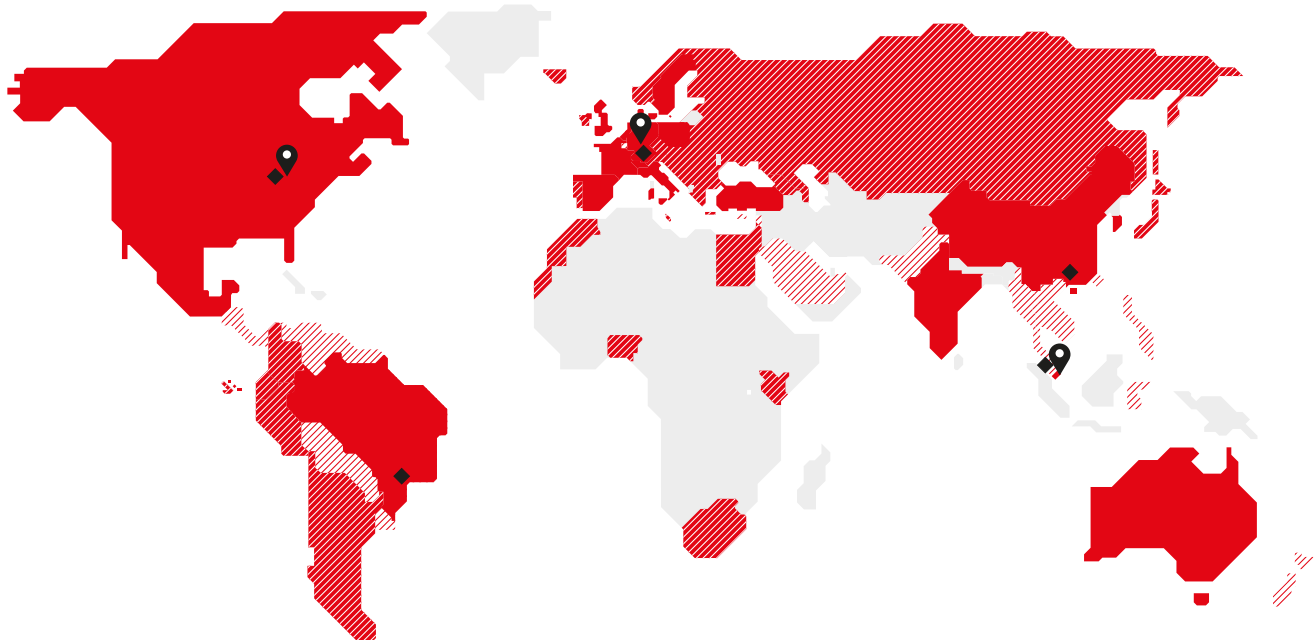

- 📍 Technological competence centers
- ◆ Production locations
- Distribution companies
- ▨ Distributor
- ▩ Distribution through neighboring country

### Technological competence centers

Owen, Germany  
New Hudson/Detroit, USA  
Singapore

### Production locations

Owen, Germany  
Unterstadion, Germany  
New Hudson/Detroit, USA  
Shenzhen, China  
São Paulo, Brazil  
Malacca, Malaysia

### Distribution companies

Australia/New Zealand  
Belgium  
Brazil  
China  
Denmark/Sweden  
France  
Germany – headquarters  
Germany – distribution company  
Great Britain  
Hong Kong  
India  
Italy  
Mexico  
Poland  
Singapore  
South Korea  
Spain  
Switzerland  
The Netherlands  
Turkey  
USA/Canada

## Our product range at a glance

### Switching sensors

- Optical Sensors
- Inductive Switches
- Capacitive Sensors
- Ultrasonic Sensors
- Fiber Optic Sensors
- Fork Sensors
- Light Curtains
- Special Sensors

### Measuring sensors

- Distance Sensors
- Sensors for Positioning
- 3D Sensors
- Light Curtains
- Bar Code Positioning Systems
- Fork Sensors

### Safety

- Safety Solutions
- Safety laser scanners
- Safety Light Curtains
- Single and Multiple Light Beam Safety Devices
- Safety Radar Systems
- Safe Locking Devices, Switches and Proximity Sensors
- Safety PLCs and Relays
- Machine Safety Services

### Identification

- Bar Code Identification
- 2D-Code Identification
- RF Identification

### Data Transmission

- Optical Data Transmission Systems

### Network and connection technology

- Connection technology
- Modular Connection Units

### Industrial image processing

- Light Section Sensors
- Smart Camera

### Accessories and Supplementary Products

- Signaling Devices
- Mounting Systems
- Reflectors

## Your contact with us

### Leuze electronic GmbH + Co. KG

In der Braike 1, 73277 Owen

Phone +49 7021 573-0

Fax +49 7021 573-199

info@leuze.com

[www.leuze.com](http://www.leuze.com)