



Area Scanning Distance Sensor rotoScan RS3 (-01, -05, -06)

Technical description



All rights reserved, especially the rights of production, distribution and translation. Duplication or reproduction in any form (print, photocopies, microfilm or data) may only be carried out with the expressed written consent of Leuze electronic GmbH & Co.

We reserve the right to make changes for the technical improvement of the product.

1	General Information	4
1.1	Explanation of Symbols	4
1.2	Declaration of Conformity	4
1.3	Short Description	5
1.4	rotoScan RS3 versions	5
1.5	Principle of Operation	6
1.6	Application examples	7
2	Safety Notices	11
2.1	Safety Standard	11
2.2	Intended use	11
2.3	Working Safely	12
2.4	Organisational Measures	12
3	Specifications.....	13
3.1	Personal safety field.....	13
3.2	Object safety field	13
3.3	Contour measurement	13
3.4	General Specifications	14
3.5	Measurement linearity of the rotoScan RS3	16
3.6	Dimensions	17
4	Delivery contents	18
5	Installation	19
5.1	Mounting to vehicles and for area safeguarding	20
5.2	Mounting neighbouring sensors	21
5.3	Mounting dimensions	22
6	Electrical connection	23
6.1	Pin assignments.....	23
6.2	Inputs/outputs	24
6.3	Wiring the plug	27
6.4	Connecting to the controller	27
7	Commissioning	29
7.1	Function control	29
	<i>Hardware and software requirements</i>	<i>29</i>
	<i>Test wiring.....</i>	<i>30</i>
	<i>Switching on the device</i>	<i>31</i>
7.2	Device configuration and device parameterisation	31
7.3	Mounting and setting up the device	32
7.4	Programming the object safety field on-site using the Teach function.....	33
8	Maintenance	34
8.1	Cleaning	34

8.2	Checking the safety fields	34
9	Status, Errors and Error Correction.....	35
9.1	Status display on the device	35
9.2	Error code output to the PC	36
9.3	Troubleshooting table	37
10	Description of the Hand-Held Terminal	38
10.1	Plug to the controller	39
10.2	Plug to the PC.....	39
11	Description of the Interface Data Packet	40
11.1	Measurement data output	40
11.2	Data packet structure	41
11.3	Data packet format.....	42
11.4	Data types.....	43

Figure 1.1:	Safety fields.....	5
Figure 1.2:	Principle of Operation.....	6
Figure 1.3:	Phase measurement.....	6
Figure 1.4:	Sidetracking skate.....	7
Figure 1.5:	DTS application.....	8
Figure 1.6:	Safeguarding danger areas.....	9
Figure 1.7:	Contour measurement.....	10
Figure 3.1:	Object size and reflectance versus distance.....	14
Figure 3.2:	Measurement linearity of the rotoScan RS3.....	16
Figure 3.3:	Dimensions.....	17
Figure 5.1:	Scanning plane.....	19
Figure 5.2:	Mounting height.....	20
Figure 5.3:	Shielding against direct irradiation.....	21
Figure 5.4:	Inclination setting to avoid direct irradiation.....	21
Figure 5.5:	Mounting kit BT - RS 3.....	22
Figure 5.6:	Mounting dimensions.....	22
Figure 6.1:	X1 pin assignments.....	23
Figure 6.2:	X2 pin assignments.....	24
Figure 6.3:	Input switching.....	24
Figure 6.4:	Output switching.....	25
Figure 6.5:	Wiring the plug.....	27
Figure 6.6:	Standard wiring.....	28
Figure 7.1:	Wiring the output contacts.....	30
Figure 7.2:	Test wiring.....	30
Figure 7.3:	Status LEDs.....	31
Figure 7.4:	Programming the object safety field using the Teach function.....	33
Figure 10.1:	Hand-Held Terminal.....	38
Figure 10.2:	Block schematic of the hand-held terminal.....	38
Figure 10.3:	Pin assignments: RS 485 interface to the controller.....	39
Figure 10.4:	Pin assignments: RS 232 interface to the PC.....	39
Figure 11.1:	Block schematic of the rotoScan.....	40
Figure 11.2:	Data packet structure.....	41
Figure 11.3:	Decoding with data type 2.....	43

1 General Information

1.1 Explanation of Symbols

The symbols used in this operating manual are explained below.



Attention!

This symbol appears in front of text which must be carefully observed. Failure to heed this information can lead to injuries to personnel or damage to the equipment.



Attention Laser!

This symbol warns of possible danger through hazardous laser radiation.



Notice!

This symbol indicates text which contains important information.

1.2 Declaration of Conformity

The distance sensor rotoScan RS 3 has been developed and produced in accordance with the applicable European standards and directives.



Notice!

The corresponding declaration of conformity can be requested from the manufacturer.

The manufacturer of the product, Leuze electronic GmbH + Co. in D-73277 Owen/Teck, possesses a certified quality assurance system in accordance with ISO 9001.

1.3 Short Description

The rotoScan device is an optical distance sensor. It could also be considered an optical, area radar unit. A laser beam scans a semicircular working field. If the beam hits a person or object, the diffuse, reflected light is detected. From the angle of radiation and the propagation time, the rotoScan unit calculates the exact coordinates of the "seen" objects.

The rotoScan can be used for the protection of persons and objects (safety category 1).

Two programmable safety fields make it possible, by means of the Teach-In process or using the supplied communication software, to adapt the safety areas to the on-site conditions, e.g. objects within the travel path boundaries of a transport system should not sound an alarm. The safety field is then simply reduced until the travel path lies outside of the safety field.

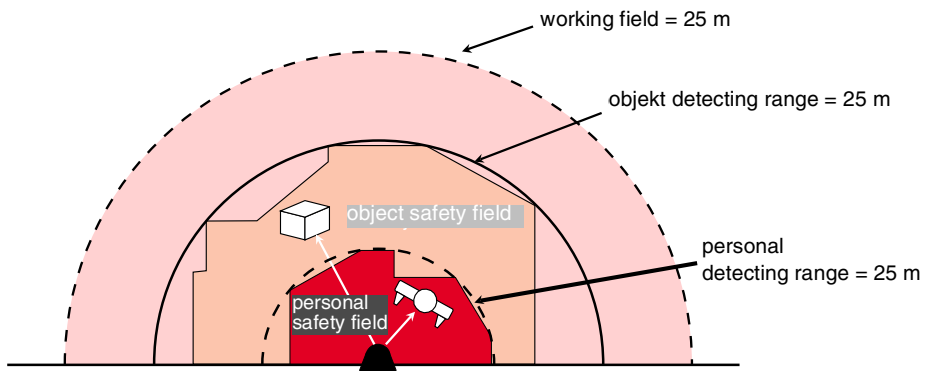

Figure 1.1: Safety fields

The safety fields can be programmed using convenient communication software or a hand-held terminal.

The rotoScan unit can be used for mobile (driverless transportation systems, sidetracking skates, ...) as well as for stationary applications (safeguarding machine danger areas, ...).

1.4 rotoScan RS3 versions

The rotoScan RS3 is offered in different model variations. These model variations are designed for various environments and have the following characteristics:

rotoScan version	Characteristic
rotoScan RS3	Standard version
rotoScan RS3 - 01	Version with safety-field changeover <ul style="list-style-type: none"> e.g. for sidetracking skates (high speed - large safety field, low speed - smaller safety field)
rotoScan RS3 - 05	Version with anti-static housing <ul style="list-style-type: none"> e.g. in very dusty environments
rotoScan RS3 - 06	Version with optics heating (-20° to +50°) <ul style="list-style-type: none"> e.g. for use in protected outdoor areas

1.5 Principle of Operation

A laser diode and transmission optic produce a directional light beam. The rotating mirror deflects the beam 90°. The rotation of the mirror scans the laser beam over a circular area. If the transmitted beam hits an object or person inside of the working field, it is reflected. Part of the reflected light is collected by the receiving mirror, reflected onto the receiving optic and focussed onto the receiving element.

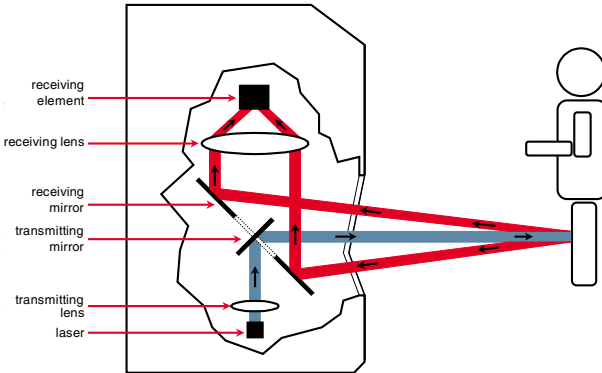

Figure 1.2: Principle of Operation

An incremental sensor gives the angular position.

The rotoScan unit works on the principle of phase measurement. The transmitted light of the laser diode is periodically modulated. The transmitted signal is then compared with the reflected signal from the receiver. The propagation time of the transmitted light to the object and back causes a phase shift between the transmitted and received signals. This phase shift is a direct measurement of the distance to the object.

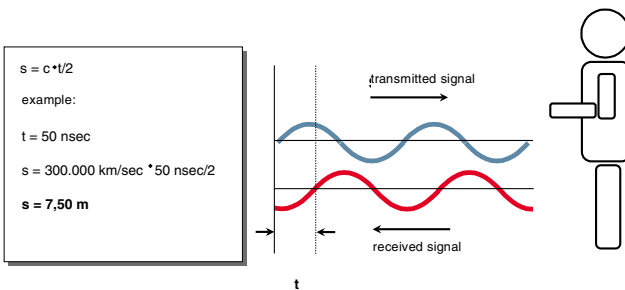

Figure 1.3: Phase measurement

1.6 Application examples

Example 1:

Sidetracking skate

There are two common requirements for industrial vehicles confined to tracks:

- Objects located in the transportation path must be recognised in time to prevent damage to the vehicle or to the load.
- Persons located in the transportation path must be protected.

These tasks are reliably solved using rotoScan.

Since industrial vehicles are frequently very wide, and persons or objects can be located in the middle as well as along the edges, the size of the effective safety field is an important factor. In order to also detect persons close to the side walls, a process has been developed that can differentiate between a person and a wall (see Chapter 7.4).

For this application, an evaluation process with "wall detection" must be used. After a safety field violation, a restart must be disabled. The activation element used to re-enable the system must be located outside of the safety field, but in view of the danger area as well as the safety field.

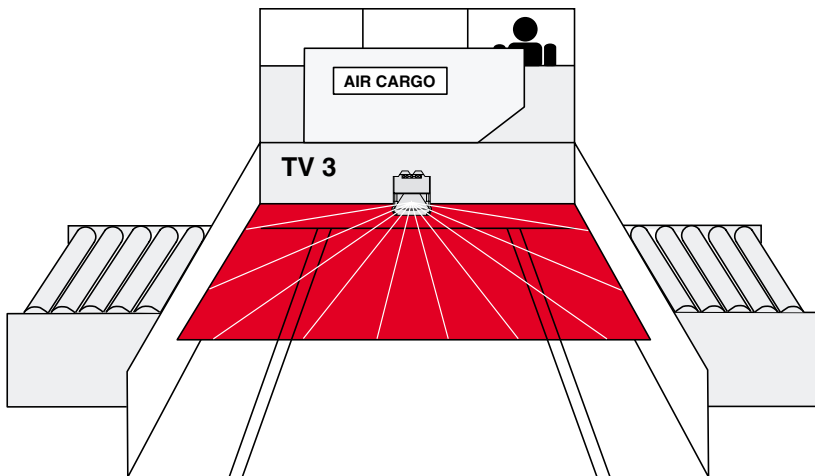

Figure 1.4: Sidetracking skate

Example 2:**DTS application**

Driverless transportation systems (DTS) must be protected so that persons who approach the vehicle are not endangered. Earlier types of protection systems such as bumpers, loop guards, etc. only allow limited vehicle speeds. Using the rotoScan unit as a 'leading bumper' results in a far larger safety area. Therefore the vehicles can drive at higher speeds. Furthermore, the rotoScan operates free from wear, thus reducing maintenance costs.

The continuous scanning of the environment and long range of the rotoScan unit allows it to be used for vehicle navigation. Objects are detected in time and can be avoided.

The process "Standard" is used with DTS applications.

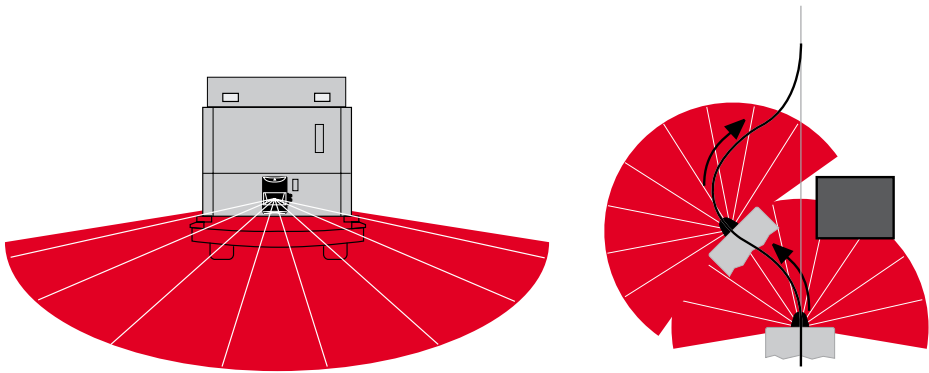

Figure 1.5: DTS application

Example 3:

Safeguarding danger areas

In modern production plants, danger areas often have to be entered by personnel. Efficient monitoring is essential to ensure that no risk is incurred from the operating machine or production plant while there is a person located in the danger area.

At the same time, the adopted safety measures should not obstruct the production process.

RotoScan fulfils this requirement.

The dual safety fields permit a graduated system of danger area safeguarding. If a person approaches the danger area and enters the object safety field, the rotoScan unit warns of the approaching danger. If the personal safety field is entered, the machine switches off.

As opposed to other solutions, the rotoScan unit also monitors danger areas having irregular contours. Adaptation to a changed environment can be made quickly.

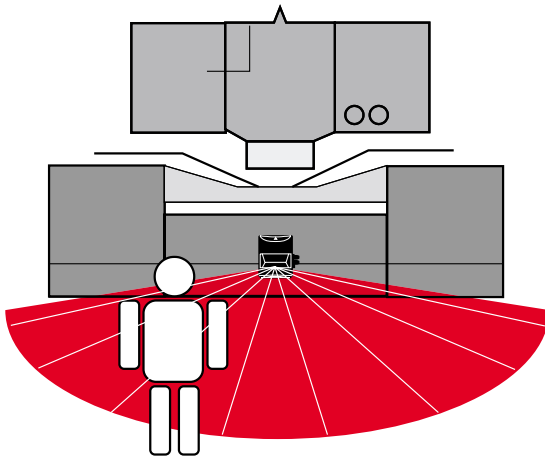

Figure 1.6: Safeguarding danger areas

Example 4:**Contour measurement**

The detection data of the rotoScan unit are continuously available at its serial interface. Using this data, the height, width and volume of the transported goods can be determined. This information can then be used to inspect or sort the goods.

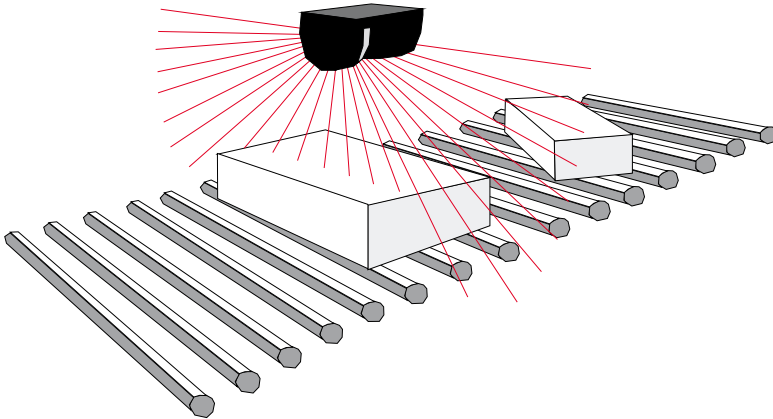

Figure 1.7: Contour measurement

2 Safety Notices

2.1 Safety Standard

The rotoScan unit has been developed, produced and tested subject to the applicable safety standards.

The rotoScan unit fulfills the technical safety requirements according to EN 954 T.1, Cat.1.

After performing a risk analysis, you may use the rotoScan RS3 in accordance with its safety category (SC1) for the protection of persons. The **operational safety** required for applications involving the protection of persons is ensured through several constructive measures.

- **Laser**

If the laser fails to function properly, the error output is immediately activated. The laser output power and the rotational speed of the rotating mirror is continuously monitored by the built-in controller to ensure that the requirements of laser protection class I are satisfied.

- **Reference measurement**

A reference measurement periodically checks the measurement function.

- Window monitoring

A separate light attachment checks the degree of soiling of the exit and entrance windows.

- **Two potential-free output contacts**

- **Software test**

The entire system is tested after switching on and during operation.

- **Personal protection**

The object alarm for the personal safety field is signaled via a forced relay.

2.2 Intended use

The rotoScan unit has been developed as a **switching protection device** (SC1) for protecting the danger areas of power-driven machinery.



Attention!

The protection of personnel and the device cannot be guaranteed if the device is operated in a manner not corresponding to its intended use.

The arrangement and integration of the machine control must conform to the local, applicable regulations for contactless protection devices used with power-driven machinery.

Areas of application

The rotoScan RS3 unit is suitable for the following applications:

- printing and paper processing machines
- sidetracking skates in continuous transport systems
- driverless transportation systems
- automated work areas
- safeguarding the operation of cranes
- overshoot controls
- automated parking systems

The following safety measures must be heeded when using the rotoScan unit.

- Use only in enclosed areas (does not apply to **rotoScan** version **RS3-06**).
- Only objects that are in clear view of the sensor can be detected.
- Objects such as glass panes and mirrors that do not reflect light back to the sensor cannot be reliably recognised.
- Pay attention to the response time when working with fast-moving objects.
- The rotoScan unit can be disturbed by direct and indirect sunlight.

Highly reflective objects with a reflectivity of $R > 95\%$ can cause faulty measurements (see Chapter 5). When using the rotoScan unit as a protection device on machines or DTS, false measurements can lead to dangers for persons.

2.3 Working Safely



Attention Laser!

The rotoScan RS 3 is a laser device of laser class 1.

Observe the applicable legal and local regulations for the operation of laser units.



Attention!

Access to or changes of the device, except where expressly described in this operating manual, is not authorized.

2.4 Organisational Measures

Documentation

All entries in this operating manual must be heeded, in particular those in the sections "Safety Notices" and "Commissioning".

Carefully store this operating manual where it is accessible at all times.

Safety regulations

Observe the locally applicable legal regulations and the rules of the employers' liability insurance association.

Qualified personnel

Mounting, commissioning and maintenance of the device must only be carried out by qualified personnel.

Electrical work must be carried out by a certified electrician.

Adjustment and change of the safety field for the protection of persons may only be carried out by an authorized person.

The **Password** must be kept locked up by the safety officer.

Repair

Repairs, in particular the opening of the housing, may only be carried out by the manufacturer or a person authorized by the manufacturer.

3 Specifications

3.1 Personal safety field

Detection area	0 - 4.5 m (relative to rotation point of the scanner) [see Page 19]
Reflectivity	≥ 1.5 % - 95 %
Object size	≥ 70 mm
Response time	100 - 1500 ms
Output	2 relay outputs, potential-free
Auxiliary output	Transistor output (PNP) 24 V/100 mA
Safety category	Safety category 1 acc. to EN 954 T.1

3.2 Object safety field

Detection area	0 - 15 m
Reflectivity	see diagram in Chap. 3.4
Object size	> 200 x 200 mm at 15 m, (see diagram in 3.4)
Response time	100 - 1500 msec, adjustable
Output	Transistor output (PNP) 24 V/100 mA

3.3 Contour measurement

Scanning range	0 - 25 m
Reflectance factor and object size	see diagram in Chap. 3.4
Output	serial interface RS 232 (9600 baud) (RS 422, RS 485, baud rate to 115 kbaud, additional analysis on request)

3.4 General Specifications

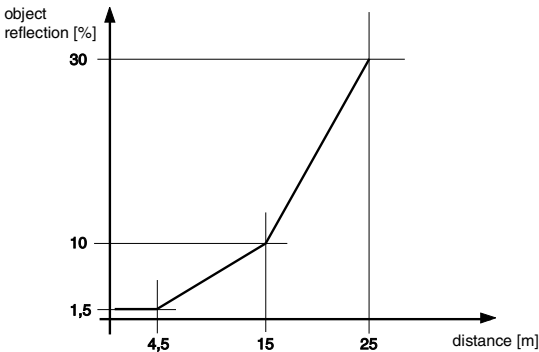
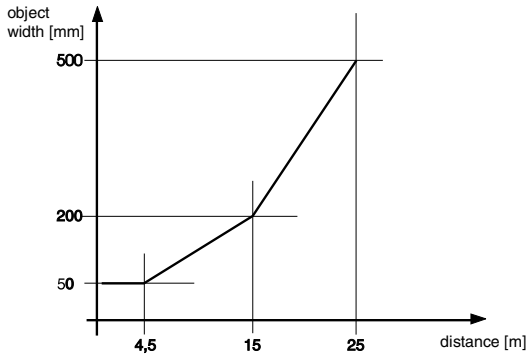

Figure 3.1: Object size and reflectance versus distance

Supply

Operating voltage	20 - 30 V DC
Residual ripple	10 %
Current consumption	approx. 800 mA (at 24 V DC)
Power consumption	20 W



Notice!

Power supply unit:

According to IEC 742, a power supply with an isolation transformer must be used. To protect against voltage interruptions, the rotoScan unit must be supplied using a suitable power supply.

Inputs

Active, Reset, Restart, Teach, Safety field switching galvanically isolated using optical coupler

Outputs

Personal safety field relay output, max. 2 A, 50 V (2 contacts) 4 *10⁵ switchings PNP transistor output, max. 100 mA
Output switching see Page 25

Object safety field PNP transistor output, max. 100 mA
Output switching see Page 25

Error PNP transistor output, max. 100 mA
Output switching see Page 25

Warning PNP transistor output, max. 100 mA
Output switching see Page 25

Interfaces

RS 232 9600 baud, no parity, 1 start bit, 1 stop bit, 8 data bits

RS 485 / RS 422 4.8 kbaud ... 115 kbaud on request

Optical properties

Angular range 180°

Angular resolution 0.25°

Scanning rate 100 ms (adjustable)

Laser safety class class 1 (eye safe), DIN EN 60825-1

General

Safety class II (all-insulated, measured at 50V)

Protection class IP 65

Operating temperature 0 ... + 50°C (RS3-06 with heating -20°C ... + 50°C)

Storage temperature - 20°C ... + 60°C

Humidity DIN 40040 table 10, code letter E (moderately dry)

Dimensions 200 x 295 x 173 (B x H x T) in mm

Connection 2 plugs (solder connection)

Cable length max. 10 m with conductor cross section 0.5 mm²

Transmitter infrared laser diode (830 nm)

Housing material PC DIN 7744 (Makrolon)

Mounting plate aluminum

Front cover PC DIN 7744 (Makrolon), scratch resistant coating

Weight approx. 5 kg

Vibration stress DIN IEC 68 part 2 - 6, 10 - 55 Hz max. 5 G

Shock DIN IEC 68 part 2 - 29, 10 G, 16 ms

Interference rejection EMC accord. to EN 61496-1

Rotating mirror drive brushless DC motor

Rotating mirror bearings maintenance-free ball bearings

3.5 Measurement linearity of the rotoScan RS3

Black object (~3% reflectance): 400 mm wide

distance (mm)	mean value (mm)	deviation (mm)
450	490	40
1050	1090	40
2050	2090	40
4460	4440	-20

White object (~90% reflectance): 400 mm wide

distance (mm)	mean value (mm)	deviation (mm)
450	520	70
1050	1110	60
2050	2090	40
4460	4440	-20

**Test object (~1.5% reflectance): 70 mm wide
background (slide projection screen with ~200% reflectance)**

distance (mm)	mean value (mm)	deviation (mm)
450	400	-50
1050	1010	-40
2050	2080	30
4050	4550	500

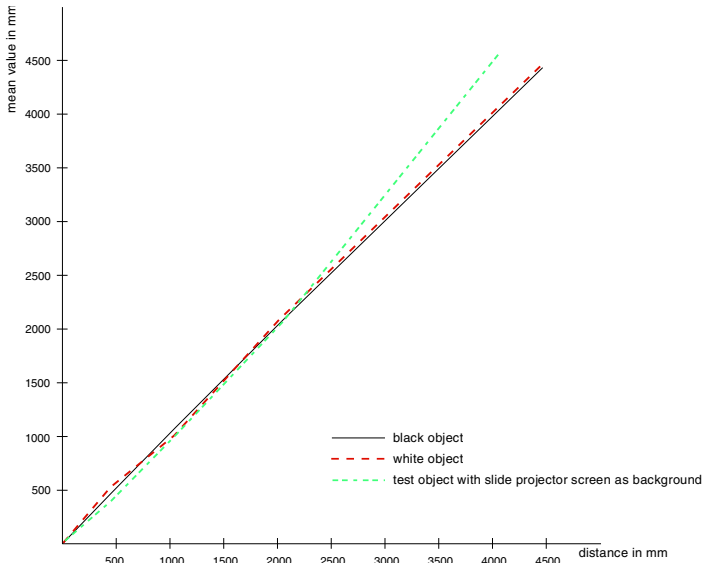

Figure 3.2: Measurement linearity of the rotoScan RS3

3.6 Dimensions

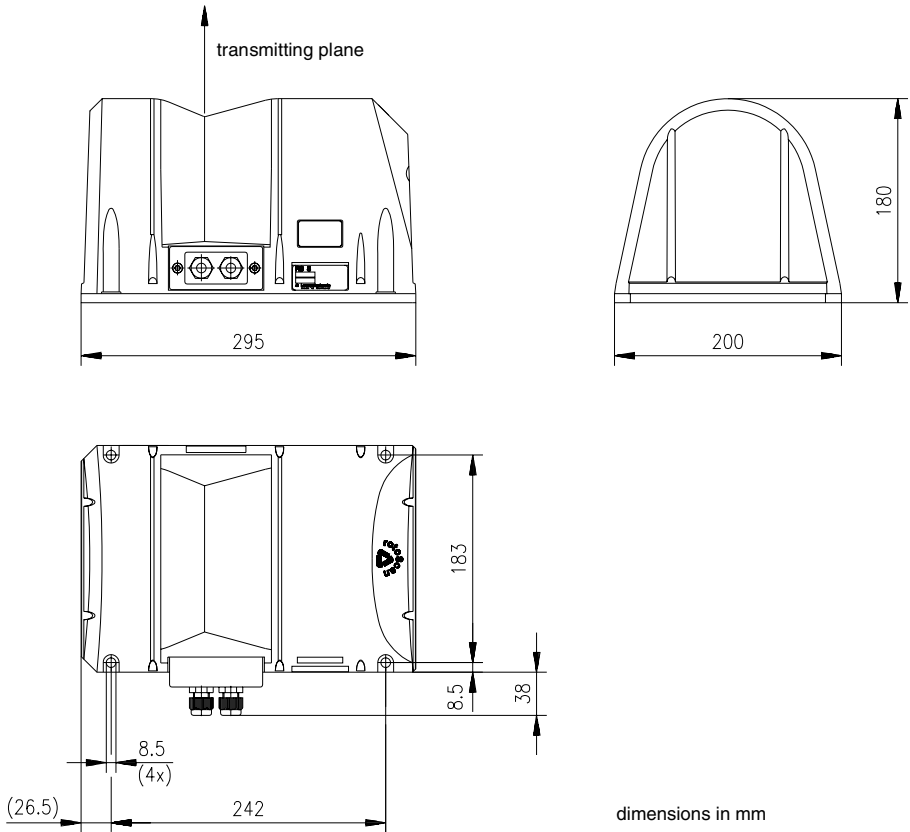

Figure 3.3: Dimensions

4 Delivery contents

The **basic unit** consists of:

- rotoScan RS 3
- plug cover with connection socket
- software CD with
 - communication software for MS DOS
 - communication software for MS Windows 9x/Me/NT/2000
 - operating instructions for both versions (DOS and Windows) in PDF format (in order to read the files, Adobe Acrobat Reader 3 or 4 is required)
- technical description/operating manual

The following **accessories** are also available:

- hand-held terminal PZ-RS3-HT
- interface cable KB-RS3-3000-S
- mounting kit BT - RS3
- RC spark suppression circuit ZF3
- integrated heating (temp. range -20°C - +50°C)
- antistatic coating of the housing

5 Installation

The rotoScan unit should be mounted so that the safety field which is to be monitored is covered by the corresponding sensor safety field.

The corresponding field for the protection of persons is a semi-circle (180°) with a radius of max. 4.5 m.

Because of the optical scanning principle, only objects with good reflective properties are detected directly in front of the sensor window. A **loop guard** or enclosure should be used to prevent persons from approaching within 40 mm of the sensor window (this corresponds to 120 mm distance from the rotation point of the scanner). Physical damage to the sensor (e.g. due to collision or climbing on) should be prevented by using a protective enclosure.

The following figure displays the relationship of the **scanning plane** with respect to the device housing. The zero point for distance measurements is taken to be the rotation point of the scanner.

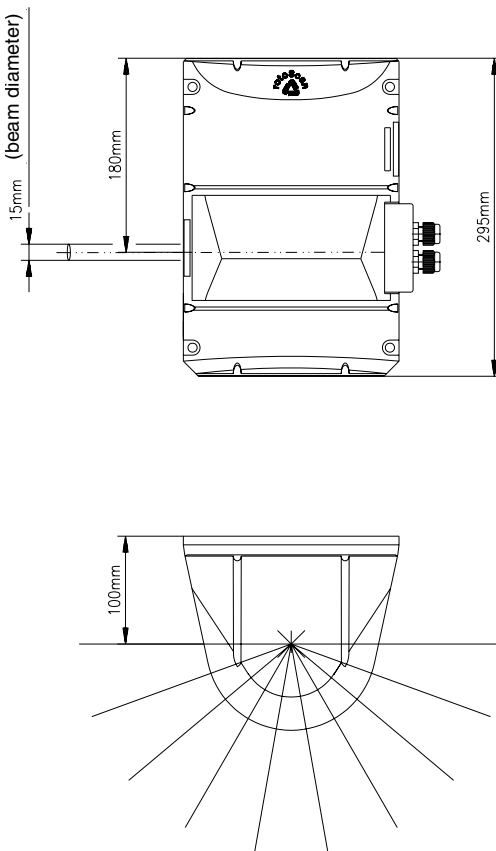

Figure 5.1: Scanning plane

Measurement accuracies of the rotoScan RS 3 for safety-related applications:

For all application examples, an industrial environment has been assumed when calculating the measurement error value (max. 95% reflectance factor, corresponding to a white wall).



Notice!

Under certain circumstances, a larger measurement inaccuracy (≥ 0.7 m) can occur with strongly reflective backgrounds such as retro-reflectors (size: 100/100 mm). The measurement inaccuracy occurs if:

- *the object distance is ≥ 3 m*
- *the size of the object to be detected is ≤ 70 mm,*
- *the retro-reflector surface lies in the scanning plane*
- *the glass is dirty*

5.1 Mounting to vehicles and for area safeguarding

In order to safeguard vehicles, the rotoScan unit is mounted to the front of vehicle so that it horizontally scans the transportation path.

Mounting height

The mounting height must be chosen so that an object with a height of 200 mm is safely detected.

A test must be carried out to ensure that a test body with a diameter of 200 mm situated in the transportation path is safely detected at the maximum scanning range distance.

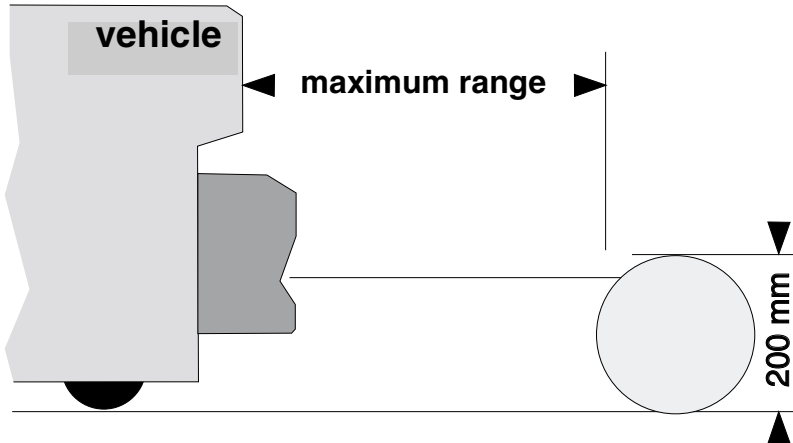

Figure 5.2: Mounting height

Installation depth

The detector unit must be mounted such that the distance between the measurement area and the vehicle does not exceed 50 mm. This is achieved either by mounting the scanner unit behind the leading edge of the vehicle, or by installing a loop guard.

When using the "wall detection" process, a dead area of 100 x 200 mm (width x depth) exists in the

area of the outer vehicle edges extending from the edge to the middle of the vehicle.



Notice!

In order to limit the laser light to the required working field, it is recommended that the rotoScan unit be mounted with a pitch of 3°.

5.2 Mounting neighbouring sensors

In order to prevent neighbouring sensors from influencing each other, the following steps should be taken:

Direct irradiation

Direct irradiation by a second, similar type sensor must be prevented by shielding the sensors from each other (e.g. using a shielding block).

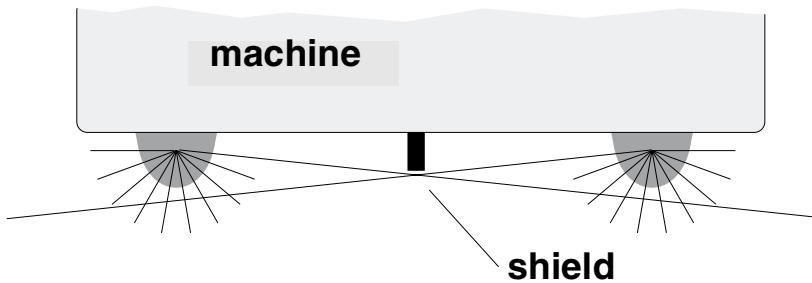

Figure 5.3: Shielding against direct irradiation

Indirect irradiation

Indirect irradiation due to light reflected from other objects in the immediate surroundings can lead to false measurements. In order to avoid these types of false measurements, the devices should be operated using different frequency channels. See Chapter 7.2.4 for instructions on setting the frequency channel.

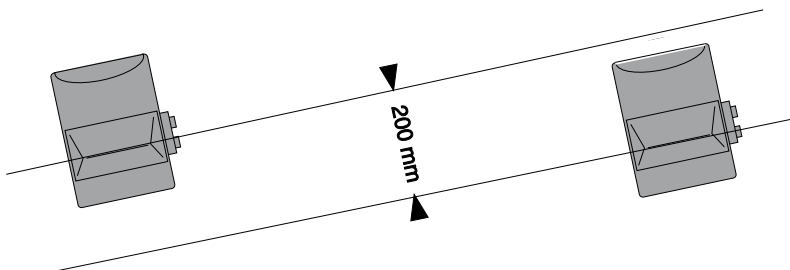

Figure 5.4: Inclination setting to avoid direct irradiation

5.3 Mounting dimensions

Mounting accessories

The rotoScan can be adjusted during commissioning using the RS 3 mounting kit.

Pitches of up to max. 7° down and 3° up are possible. The kit makes possible lateral inclination of +/- 5°. M8 x 20 screws are used to fasten.

One advantage of this mounting kit is that the set inclination angle is preserved when changing out the device.

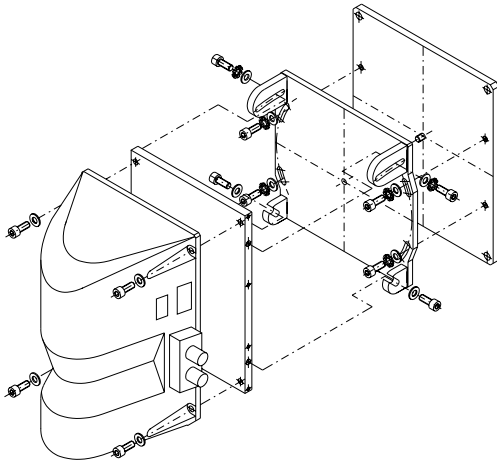

Figure 5.5: Mounting kit BT - RS 3

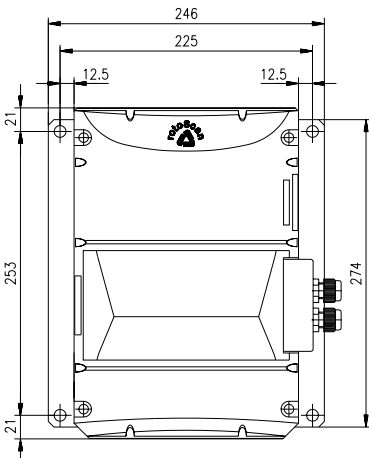

Figure 5.6: Mounting dimensions

6 Electrical connection

The power supply to the rotoScan must be protected using a 1.6 A semi-time lag fuse.

6.1 Pin assignments

Plug X1: voltage supply and interfaces

	Pin	Signal	Description
	1	GND	ground, op. voltage
	2	UB	20 ... 30 V DC
	3	Opto-GND	optical coupler ground
	4	**teach	teach-in safety fields
	5	**Switching	safety field preselection
	With the RS 3-01 , the safety field switching is made via PIN 5 . If +24 V DC is present at PIN 5 , the personal safety field is active; if, however 0 V DC is present, the object safety field is active.		
	6	COM_GND	interface ground
	7	R x D	RS 232 received data
	8		*
	9	RS 485A	RS 485 line A
	10	RS 485B	RS 485 line B
	11		* A/D input 0 ... 10 V
	12		* analogue input ground
	13		* D/A output 0 ... 10 V
	14	active	transmitter on (input)
	15	error	device error
	16	Object 1	personal safety field occupied
	17	Object 2	object safety field
	18	Warning	window soiling (output)
	19	T x D	RS 232 transmitted data
	20		*
	21	RESET	error reset and restart
	22		*
	23		*
	24		* increment alg.(input)
	25	** SF o.k.	pacing aid

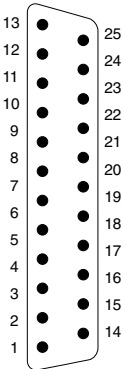

X1
soldering
side

Figure 6.1: X1 pin assignments

*) for customer-specific expansions only

**) necessary for the hand-held terminal only

Pin X2: output contacts

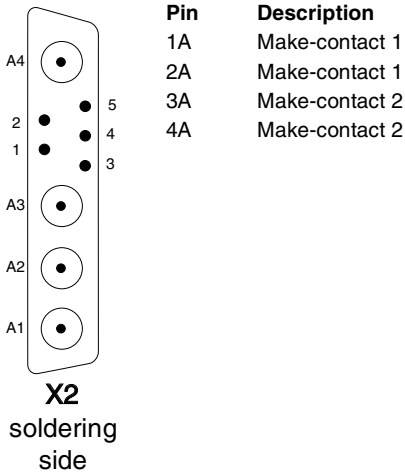

Figure 6.2: X2 pin assignments

6.2 Inputs/outputs

The operating voltage of 20 ... 30 V DC is applied between X1-2 and X1-1.

Input switching

The signal inputs are isolated via an optical coupler for potential-free coupling. The optical coupler ground X1-3 must, therefore, be grounded separately or bridged with the operating voltage ground X1-1.

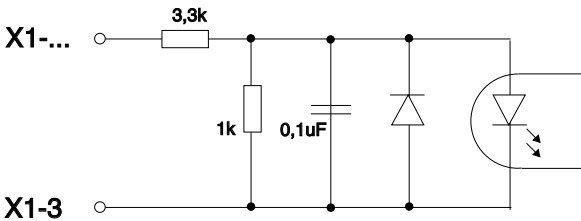

Figure 6.3: Input switching

"Active"

If the active input X1-14 is set to "1" (+UB), the device is operational (ready). If the input is set to "0", the laser is switched off (standby). This is indicated by the status display (Error and Warning LEDs on).

"RESET"

The reset input X1-21 has several functions depending on the operating status:

- Enable restart after a safety field violation.
- New-start after correcting a device error. A high signal of at least 3 s duration triggers a RESET.
- Reset all device parameters. This is done by carrying out a "RESET" during the device start-up. This resets the device to its default parameters (see Chapter 7.1.6).



Attention!

Protect the reset function against accidental activation using a suitable logic switching circuit if necessary.

This input must be set from a separate button and may not be connected to the rest of the vehicle controls in order to prevent unintentional enabling of the system. The restart button must be positioned so that it cannot be activated by a person standing in a safety field.

"Teach"

The teaching input X1-4 is only used from the hand-held terminal for starting a teaching process and should be bridged with the Opto_GND X1-3 in the customer plug.

"Switching"

The switching input X1-5 is only used from the hand-held terminal for selecting the safety field to be programmed and should be bridged with the Opto_GND X1-3 in the customer plug.

Output switching

The signal outputs are used to control indicator lamps or relays which indicate the device status. This is switched from a transistor output set to "active high" (operating voltage).

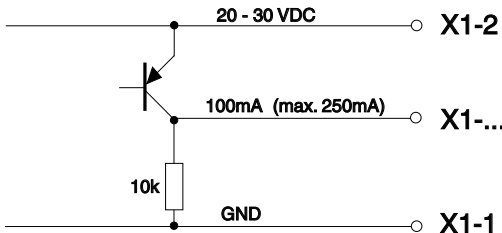

Figure 6.4: Output switching

"Error"

If X1-15 = "active high", this signals that the device is ready for operation. An output condition of "low" indicates one of the following conditions:

- device error
- unacceptable window soiling
- restart disabled
- operating status "Programming"
- standby

"Warning"

An output condition of "low" indicates:

- acceptable window soiling
- standby

"Object 1"

Low indicates: personal safety field occupied and restart disabled.

"Object 2"

Low indicates, object safety field occupied.

"Safety field o.k."

The output X1-25 is only used with special versions of the hand-held terminal.

Relay contacts

The two-channel relay contacts X2-A1 ... A4 can be connected directly to the safety circuit of the customer controller. Open contacts indicate that the personal safety field has been violated.

Serial interface

The RS 232C serial interface allows communication between a PC and the device and has a fixed data transfer rate of 9600 baud. The inputs and outputs are electrically isolated via an optical coupler and a DC-DC converter for the operating voltage. Distance measurement values are continuously sent to the output during measurement operation.

An additional serial interface (RS 485) for transferring data to the customer controller can be added on request.

6.3 Wiring the plug

The plug set shipped with the device must be used. The following components are included:

- Plug cover with sealing ring and fastening screws, hex size 3
- 2 PG cable glands (PG 9)
- SubD plug, 25 pin socket, solder connection
- SubD plug, 9 pin socket (4 high-current and 5 standard contacts), solder connection
- Ferrite sleeve type 742 7101 or similar (clamp to the supply cable directly behind the plug)

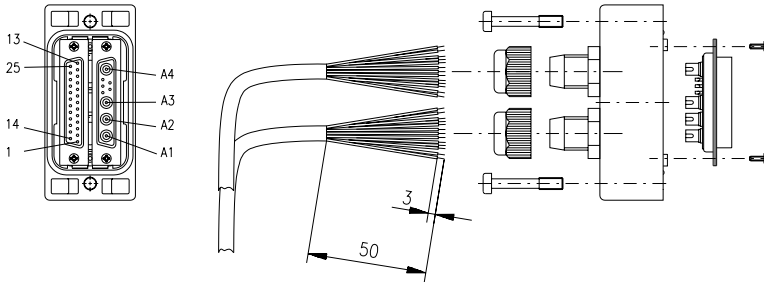

Figure 6.5: Wiring the plug

The following must be observed when wiring the plug:

Cable cross-section	= 0.14 - 0.5 mm ²
Cable outer diameter	= 5 - 9 mm
Cable length for RS 232	= 10 m
Cable length for RS 485	= 500 m

Use shielded cable. Connect the shielding in the controller to ground.

6.4 Connecting to the controller

The following examples show possibilities for connecting the sensor to the customer controller.

For technical safety applications, the serial switching must have the same level of protection. The cables to the output contacts must be run so that they are protected.

The device is ready for operation after connecting the operating voltage to pin 2 (+UB) and pin 1 (GND), and after activating the device by connecting pin 14 (active) with +UB and pin 3 (Opto_GND) with pin 1 (GND).

Standard wiring

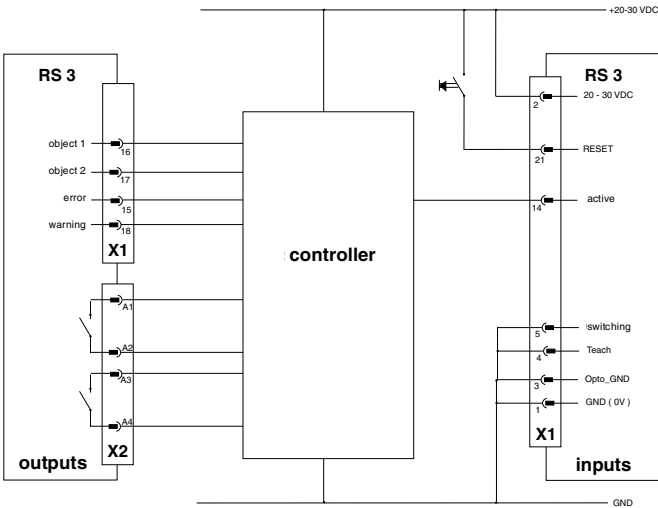

Figure 6.6: Standard wiring

If electrical isolation is not needed at the inputs, the Opto_GND pin 3 can be bridged with the supply GND.

When using automatic restart (self-enable after 100 ms of unoccupied safety field), the reset input is only used for resetting errors.

All unused inputs in the device plug should be connected to ground to avoid unwanted signals due to interference.

7 Commissioning

The device is set up by the customer in order to adapt its use to the respective application.

The programming for the protection of persons may only be carried out by safety officers. A six-character password is used for access restriction.

7.1 Function control

The following steps serve to familiarise the first-time user with the functions and programming possibilities.

7.1.1 Hardware and software requirements

When working with the device for the first time, the basic unit (see Chapter 4: "Delivery contents") and a hand-held terminal (accessory) with extension cable to the PC are required. A power supply with 20 ... 30 V DC, min. 1 A is required for the voltage supply; the requirements given in Chapter 3.4 also must be fulfilled.

For use under MS DOS, the PC to be used should meet the following requirements:

- 80386
- VGA screen
- 512 k main memory
- 300 k hard disk space
- CD-ROM drive
- RS 232 interface
- MS-DOS version 3.3 or later

For use under MS Windows 9x/Me/NT/2000, the PC to be used should meet the following requirements:

- A Pentium® or faster Intel® processor (or compatible model, e.g. AMD® or Cyrix®)
- At least 8 MB main memory (RAM)
- A CD-ROM drive
- A hard disk with at least 8 MB free memory.

If the safety-field values or configuration values are to be stored, you will require additional disk space.

- A mouse
- A free RS 232 interface (serial port)
- Microsoft® Windows 9x/Me/NT/2000

Wiring the output contacts

If only two wires are provided with the customer controller, the two make-contact outputs can be wired in series. If a break in one of the wires occurs, this condition will also be indicated.

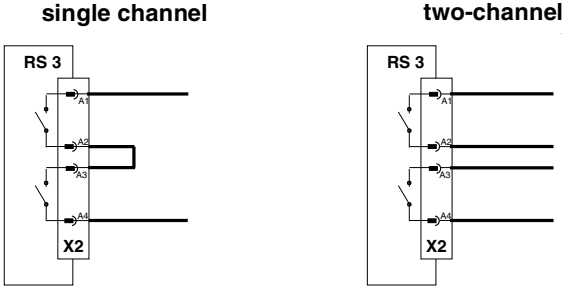

Figure 7.1: Wiring the output contacts

7.1.2 Test wiring

The following connections must be made to the plug shipped with the unit (see 6.1):

- X1-2 Operating voltage 20 ... 30 V DC
- X1-1 Operating voltage-GND (0 V)X1-14 signal input "active"
- X1-3 Signal input-GND (Opto-GND)

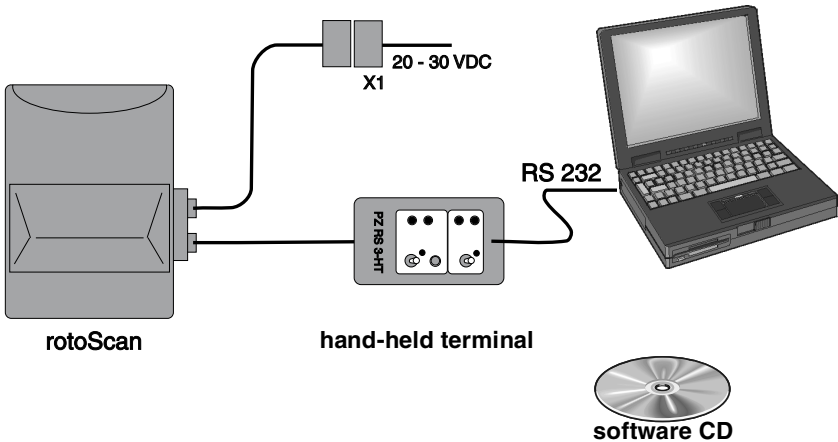

Figure 7.2: Test wiring

7.1.3 Switching on the device

There are 6 LEDs which indicate the device status. These can be seen through a transparent window next to the device plug.

After switching on, the device is initialised and the status display with the 6 LEDs in undefined for approx. 10 s. Afterwards, the yellow Error LED illuminates until the nominal rotational speed of the rotating mirror is achieved. Once the yellow Error LED goes out, the device is ready for operation. With devices having the basic configuration (restart-disable on), the Error LED illuminates and signals: "Restart disabled".

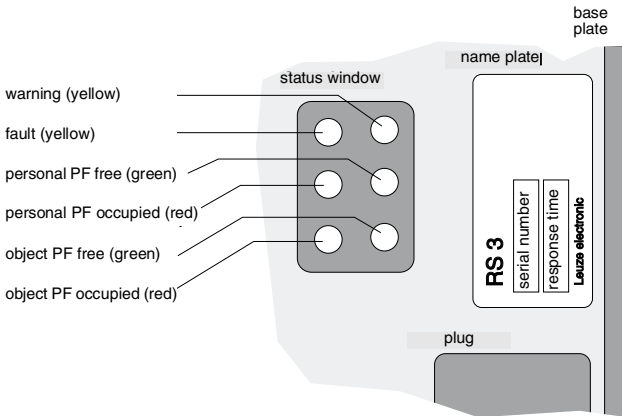

Figure 7.3: Status LEDs

7.2 Device configuration and device parameterisation

To perform the device configuration and parameterisation, you require the software program "RS3-Config", which is included in the delivery contents.



Notice!

A description of the program can be found in the software manual, which is also included in the delivery contents.



Attention!

We assume here, that you perform the application-specific configuration and parameterisation of the rotoScan RS3 using this software manual.

Proceed as follows:

- Install the program on your PC.
- Apply the supply voltage to the rotoScan RS3. The device now attempts to communicate with your PC. This procedure can be monitored on the screen.
- Once the connection between the rotoScan RS3 and the PC has been established, you can, after entering the appropriate password, change the safety fields and application-dependent parameters of the rotoScan RS4.

The default password of the rotoScan RS3 is "RS3LEU"

- After configuring, the rotoScan RS3 is ready for operation.

The "RS3-Config" software is responsible for the following tasks:

- setting the application-specific device parameters
- defining the safety fields for the protection of persons and the protection of objects



Attention!

*Before commissioning the device, you **must** adapt the device parameters to your application. To do this, configure the rotoScan RS3 using the software manual in such a way that the danger area which is to be protected is secured by the device.*

7.3 Mounting and setting up the device

Set up and check the mounted device according to the notices in Chapter 5.

Device pitch

When mounting the device on vehicles, it is advantageous to mount the device with a forward pitch that causes the transmitted beam to hit the floor at a distance twice that of the safety field depth. This prevents highly reflective objects at further distances from causing false readings.

When using the evaluation process "wall detection", the borders of the transportation path in the area of the scanning plane must satisfy the corresponding requirements. (see 7.4)

Inclination

The device may have a maximum sideways inclination of 1.5° with respect to the transportation borders.

7.4 Programming the object safety field on-site using the Teach function

The parameters can be programmed by inserting the hand-held terminal between the device and the customer plug.

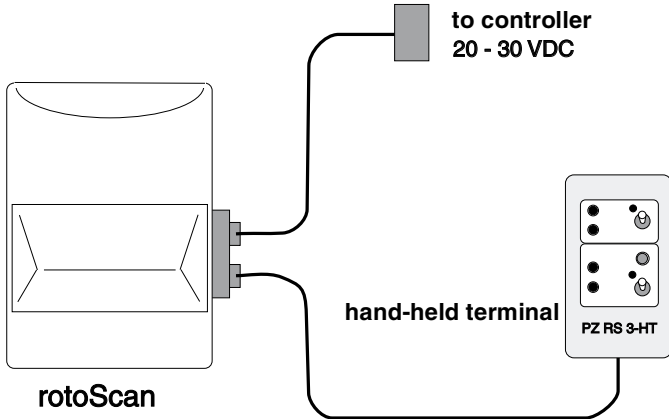

Figure 7.4: Programming the object safety field using the Teach function

The hand-held terminal can be used to define any safety field using the Teach function.

- Set-up the rotoScan unit in the desired surroundings and simulate any missing border surfaces with a temporary barrier (e.g. using a box).
- Switch the hand-held terminal to safety field 2.
- By pressing the Teach button (min. 3 s), the teaching process is started (yellow LED flashes), whereby the surroundings are scanned for 30 s and a safety field is calculated from the existing contour.
- After the yellow LED goes out, the safety field contour is saved and enabled. The defined safety field can then be changed by loading it into a PC and editing it in the "Object" window.

An error condition can be reset from the hand-held terminal by switching the "Safety field 1/2" switch. To do this, switch to position "2" for approx. 3 s and then back to position "1".

8 Maintenance

8.1 Cleaning

The optical window of the rotoScan unit must be cleaned monthly or as required (Warning LED). Use a soft cloth and cleaning agent (standard window cleaner) to clean the window.



Attention!

Do not use solvents or cleaning agents containing acetone. Use of improper cleaning agents can damage the optical window.

8.2 Checking the safety fields

The response of the personal safety field must be checked annually by a safety officer.

The response can be tested by violating the safety field using a vertical test body and comparing the response distance with safety field dimensions which were defined when the device was commissioned.

9 Status, Errors and Error Correction

9.1 Status display on the device

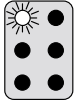

Error message
yellow flashing

- device error
- unacceptable window soiling

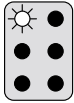

Error message
permanent yellow

- restart disabled
- Operating status "Programming"

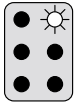

Warning message

- acceptable window soiling

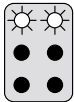

Standby

- laser switched off

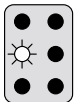

Personal safety field
(red LED)

- personal safety field violated

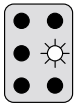

Personal safety field
(green LED)

- personal safety field free after restart

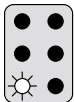

Object safety field
(red LED)

- safety field occupied

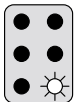

Object safety field
(green LED)

- safety field free

9.2 Error code output to the PC

If a device error occurs, the device status with error code is output instead of the distance data.

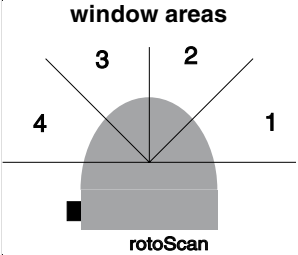
Error No.	Description of error	Corrective action
000 ... 449	internal device error 401 motor speed too low 402 motor speed too high 421 motor speed does not reach nominal speed	check operating voltage attempt a new-start after 10 min
450 ... 1999	device initialisation	switch device off and on or reset
2000 ... 3999	measurement operation 2518 ... 2525 under and over-voltage control of the internal supply	check operating voltage
2600 ... 2699	zero distance measurement	eliminate extraneous light radiation, if necessary from another sensor
3300 ... 3399	unacceptable window soiling 3310 window area 1 3311 window area 2 3312 window area 3 3313 window area 4 3314 reference - RK 3317 reference drift too large	clean window  window areas rotoScan
4000 ... 7999	dialog operation	
4000 ... 4099	serial communication 4007 wrong password 4008 " "	check interface; enter password
4500 ... 4599	safety field generation 4505 safety field too small 4506 safety field too large 4507 distance too large	check parameters check surroundings with Teach function $r = 4.5 \text{ m}$ exceeded
5000 ... 5099	parameter check 5002 safety field too small 5003 safety field too large	check parameters
10000 ... 11999	internal device errors	

9.3 Troubleshooting table

Status display	Possible cause	Corrective action
all LEDs out	missing or reversed operating voltage	control operating voltage and plug wiring (see 6.1)
LEDs undefined	faulty initialisation	RESET
restart	restart disabled after a violation of the personal safety field	press restart button (see 6.2)
error	window soiled device error	clean window (see 8.1)(see 9.2)
	simultaneous warning (standby)	check input "active" (see 6.2)
safety field free, in spite of object	- safety field too small - object reflection insufficient - object size too small	check safety field with PC see diagram in 3.4
safety field always occupied	- safety field too large - strongly reflecting objects - wall detection surroundings violated	check safety field with PC cover objects, tilt device if necessary (see 5.1-4) check application requirements

10 Description of the Hand-Held Terminal

The hand-held terminal PZ rotoScan-HT is built into an easy-to-handle unit.

Functions:

- programming the safety field contours of the two safety fields
- function control during commissioning
- allows connection of the device to a PC

The hand-held terminal is inserted as a plug adapter between the rotoScan unit and the device plug (customer controller). An RS 232 interface cable can be plugged into the front of the terminal (1:1 connection, 9 pin).

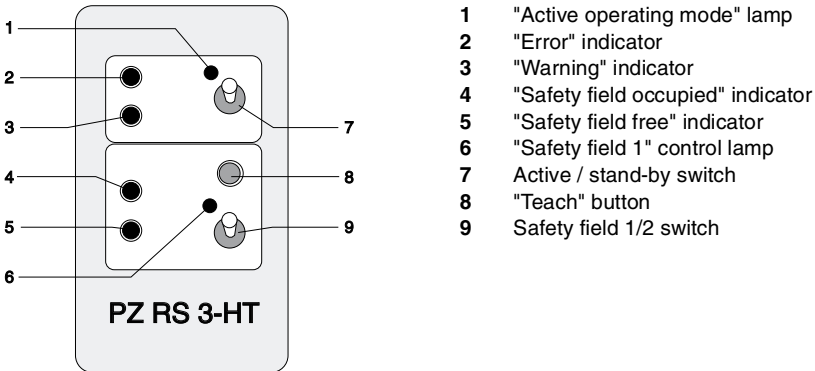

Figure 10.1: Hand-Held Terminal

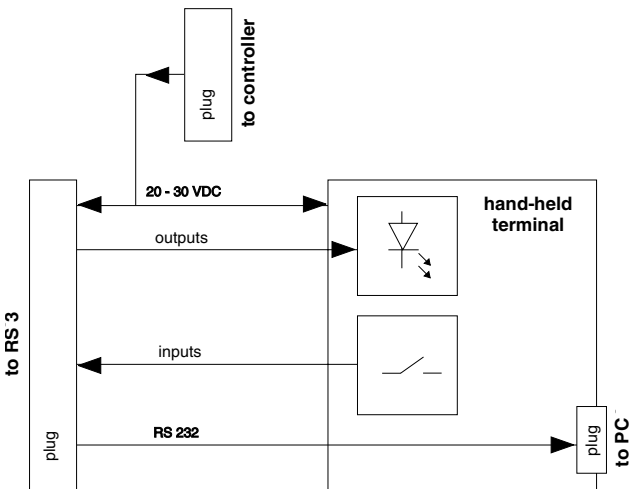
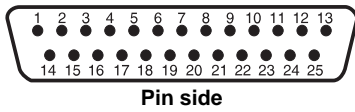

Figure 10.2: Block schematic of the hand-held terminal

10.1 Plug to the controller



PIN	Signal	Description
1	GND	Ground/operating voltage
2	U _B	20 ... 30 V DC
9	RS 485A	
10	RS 485	

Figure 10.3: Pin assignments: RS 485 interface to the controller

10.2 Plug to the PC

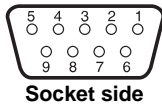

PIN	Signal	Description
2	TxD	RS 232 transmitted data
3	RxD	RS 232 receiver data
5	GND	Ground/interface

Figure 10.4: Pin assignments: RS 232 interface to the PC

11 Description of the Interface Data Packet

In this chapter, the data packet and data formats which are output by the rotoScan to the serial interface are explained.

11.1 Measurement data output

The output of the current distance measurement values takes place in parallel with the measurement and safety field analysis.

object

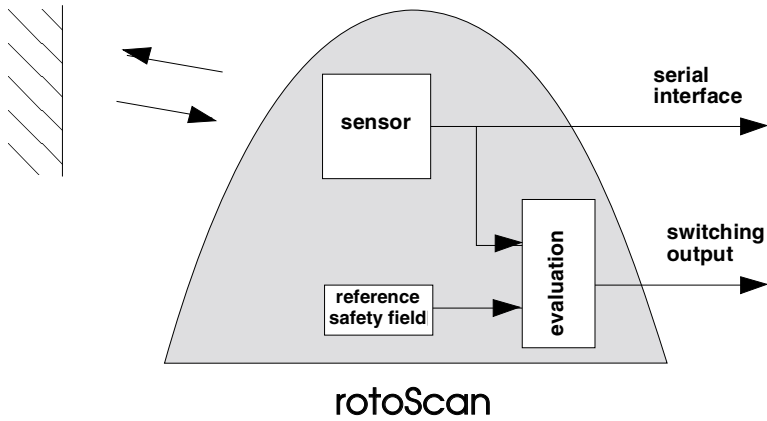

Figure 11.1: Block schematic of the rotoScan

The measurement data are configured using the communication software in the window "RS 232" (see separate instructions).

11.2 Data packet structure

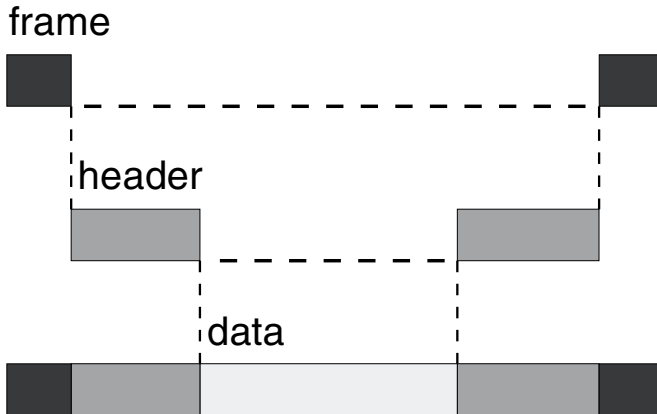

Figure 11.2: Data packet structure

Frame:

The data packet begins with the control characters "STX" to signal the beginning of the data packet and ends with the characters "ETX".

Header:

The header contains information about the type and length of data contained in the data packet. The type of data indicates the contents of the data which follow the header.

Following the data are information concerning the device status the segment number and a checksum byte.

User data:

The data contains either distance measurement values for each sector in increasing order or the device parameters.

Transmission:

ASCII characters are used with the following specifications:

- characters with values 0 ... 32 = control characters for protocol
- characters with values 128 ... 255 = information

Format of the data bits:

the following settings are used for the data bytes during transfer:

- no parity
- 1 startbit
- 8 data bits
- 1 stop bit

11.3 Data packet format

Position	Character	ASCII value	Description
0	STX	2	Start of frame
1	Type	128 ... 255	Data type
2	Length (i / 2) *	128 ... 255	Number of user data in word
3 ... (2+i) *	User data	128 ... 255	Measurement values, parameters or error code
3+i *	Status	128 ... 255	Status of the switching inputs
4+i *	Segment	128 ... 255	Segment number
5+i *	Checksum byte	128 ... 255	
6+i *	ETX	3	End of frame

*) i = length in bytes

Format of the status byte

Bit	Name	Description
0	Switching state personal SF	0 = output contacts closed (SF free) 1 = output contacts open (SF violated)
1	Switching state object SF	0 = safety field free 1 = safety field occupied
2	Error	0 = device ready 1 = device error
3	Warning	0 = no window soiling 1 = window cleaning required
4	Active	0 = standby (laser switched off) 1 = all functions active
5	Reserved	
6	Request confirmation	1 = dialog request obtained
7	Constant	1

11.4 Data types

After subtraction from 128, the following order for the data type is valid:

Type	Comment	Number of user data [bytes]
1	Current distance measurement values, resolution 60 mm, range 8 m	45 per 90° segment
2 *		90 per 90° segment
11	Device parameters: Personal safety field, Application values	254
12	Device parameters:	254
13	Device parameters: Object safety field	254
14	Device parameters:	254
15	Device status after error	

*) note concerning decoding data type 2:

Output of the distance measurement values with data type follows with the high byte first, then the low byte last.

For decoding, the MSB of each byte is removed and then combined into a 14 bit word. The two highest value bits are set to zero. The LSB of the resultant word corresponds to a distance difference of 4 mm.

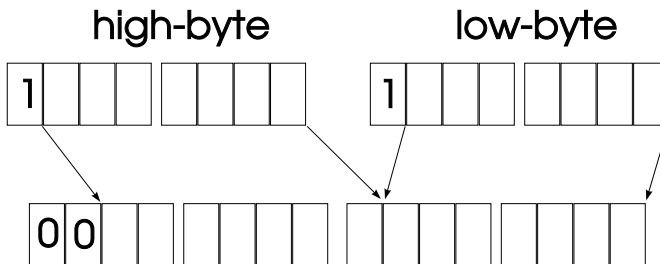

Figure 11.3: Decoding with data type 2