

the sensor people

## AMS 3007*i* SSI Optical Laser Measurement System

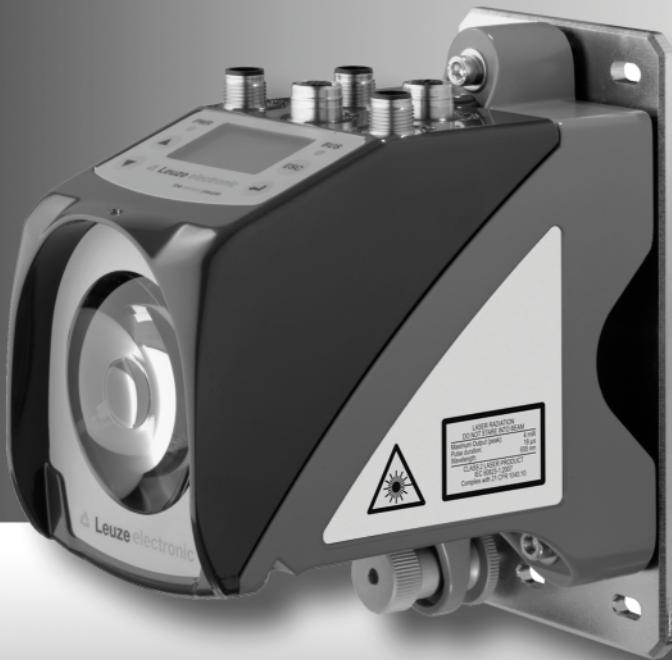

en 01-2015/08\_50130339  
We reserve the right to  
make technical changes

© 2015

Leuze electronic GmbH + Co. KG

In der Braike 1

D-73277 Owen / Germany

Phone: +49 7021 573-0

Fax: +49 7021 573-199



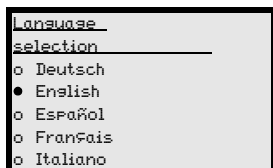
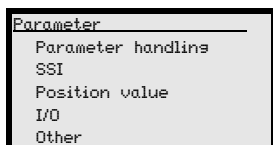
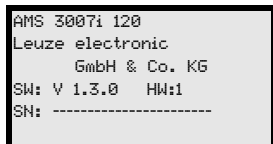

<http://www.leuze.com>

[info@leuze.de](mailto:info@leuze.de)

**The main menus**



**Device buttons:**

-  Navigate upward/laterally
-  Navigate downward/laterally
-  **ESCAPE** leave
-  **ENTER** confirm

**Input of values**

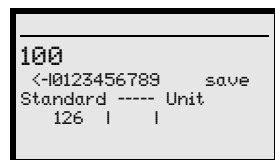

-  Delete character
-  Enter digit
-  Save input

**Device information - main menu**

This menu item contains detailed information on

- Device model,
- Manufacturer,
- Software and hardware version,
- Serial number.

No entries can be made via the display.

**Status and measurement data - main menu**

- Display of status-, warning-, and error messages.
- Status overview of the switching inputs/outputs.
- Bar graph for the reception level.
- Activated interface.
- Measurement value.

No entries can be made via the display.  
See "Indicators in the display" on page 39.

**Parameter - main menu**

Configuration of the SSI interface is performed via the "SSI" menu item.

**Language selection - main menu**

- Selection of the display language.
- See "Language selection menu" on page 48.

**Service - main menu**

- Display of status messages.
  - Display of diagnostic data.
- No entries can be made via the display.  
See "Service menu" on page 48.

<b>1</b>	<b>General information</b>	<b>4</b>
1.1	Explanation of symbols	4
1.2	Declaration of conformity	4
1.3	Description of functions AMS 3007i	5
<b>2</b>	<b>Safety</b>	<b>6</b>
2.1	Intended use	6
2.2	Foreseeable misuse	7
2.3	Competent persons	7
2.4	Exemption of liability	7
2.5	Laser safety notices	8
<b>3</b>	<b>Fast commissioning / operating principle</b>	<b>11</b>
3.1	Mounting the AMS 3007i	11
3.1.1	Mounting the device	11
3.1.2	Mounting the reflector	11
3.2	Connecting the voltage supply	12
3.3	Display	12
3.4	SSI interface	12
<b>4</b>	<b>Technical data</b>	<b>13</b>
4.1	Specifications of the laser measurement system	13
4.1.1	General specifications AMS 3007i	13
4.1.2	Dimensioned drawing AMS 3007i	15
4.1.3	Type overview AMS 3007i	16
<b>5</b>	<b>Installation and mounting</b>	<b>17</b>
5.1	Storage, transportation	17
5.2	Mounting the AMS 3007i	18
5.2.1	Optional mounting bracket	20
5.2.2	Parallel mounting of the AMS 3007i	21
5.2.3	Parallel mounting of AMS 3007i and DDLS optical data transmission	22
5.3	Mounting the AMS 3007i with laser beam deflector unit	23
5.3.1	Mounting the laser beam deflector unit with integrated mounting bracket	23
5.3.2	Dimensioned drawing of US AMS 01 deflector unit	24
5.3.3	Mounting the US 1 OMS deflector unit without mounting bracket	25

<b>6</b>	<b>Reflectors</b>	<b>26</b>
6.1	General information	26
6.2	Description of the reflective tape	26
6.2.1	Specifications of the self-adhesive foil	27
6.2.2	Specifications of the reflective tape on a metal plate	27
6.2.3	Dimensioned drawing of reflective tape on a metal plate	28
6.2.4	Specifications of heated reflectors	29
6.2.5	Dimensioned drawing of heated reflectors	30
6.3	Selecting reflector sizes	31
6.4	Mounting the reflector	32
6.4.1	General information	32
6.4.2	Mounting the reflector	32
6.4.3	Table of reflector pitches	35
<b>7</b>	<b>Electrical connection</b>	<b>36</b>
7.1	Safety notices for the electrical connection	36
7.2	PWR – voltage supply / switching input/output	37
7.3	SSI	37
7.4	Service	38
<b>8</b>	<b>Display and control panel AMS 3007i</b>	<b>39</b>
8.1	Structure of the control panel	39
8.2	Status display and operation	39
8.2.1	Indicators in the display	39
8.2.2	LED status displays	41
8.2.3	Control buttons	42
8.3	Menu description	43
8.3.1	The main menu	43
8.3.2	Parameter menu	44
8.3.3	Language selection menu	48
8.3.4	Service menu	48
8.4	Operation	49
<b>9</b>	<b>SSI interface</b>	<b>52</b>
9.1	Principle functionality of the SSI interface	52
9.1.1	SSI sequence diagram	53
9.1.2	Cable length as a function of the data rate	54

9.2	SSI - electrical connection .....	54
9.3	Default settings of the SSI interface .....	55
9.3.1	Changing the SSI settings via the display .....	55
<b>10</b>	<b>Diagnostics and troubleshooting .....</b>	<b>56</b>
10.1	Service and diagnostics in the display of the AMS 3007i .....	56
10.1.1	Status messages .....	56
10.1.2	Diagnostics .....	57
10.1.3	Expanded diagnostics .....	57
10.2	General causes of errors .....	58
10.2.1	Power LED .....	58
10.3	Interface errors .....	58
10.3.1	BUS LED .....	58
10.4	Status display in the display of the AMS 3007i .....	59
<b>11</b>	<b>Type overview and accessories .....</b>	<b>60</b>
11.1	Part number code .....	60
11.2	Type overview AMS 3007i (SSI) .....	60
11.3	Overview of reflector types .....	60
11.4	Accessories .....	61
11.4.1	Accessory mounting bracket .....	61
11.4.2	Accessory deflector unit .....	61
11.4.3	Accessory M12 connector .....	61
11.4.4	Accessory ready-made cables for voltage supply .....	62
11.4.5	Accessory ready-made cables for the SSI interface .....	63
<b>12</b>	<b>Maintenance .....</b>	<b>65</b>
12.1	General maintenance information .....	65
12.2	Repairs, servicing .....	65
12.3	Disassembling, packing, disposing .....	65

## 1 General information

### 1.1 Explanation of symbols

The symbols used in this operating manual are explained below.



**Attention!**

*This symbol precedes text messages which must strictly be observed. Failure to comply with this information results in injuries to persons or damage to the equipment.*



**Attention Laser!**

*This symbol warns of possible danger caused by hazardous laser radiation.*



**Notice!**

*This symbol indicates text passages containing important information.*

### 1.2 Declaration of conformity

The AMS 3007*i* absolute measuring optical laser measurement system was designed and manufactured in accordance with applicable European directives and standards.



**Notice!**

*The Declaration of Conformity for these devices can be requested from the manufacturer.*

The manufacturer of the product, Leuze electronic GmbH + Co. KG in D-73277 Owen/Teck, possesses a certified quality assurance system in accordance with ISO 9001.



### **1.3 Description of functions AMS 3007*i***

The AMS 3007*i* optical laser measurement system calculates distances to fixed as well as moving system parts. The distance to be measured is calculated according to the principle of the propagation time of radiated light. Here, the light emitted by the laser diode is reflected by a reflector onto the receiving element of the laser measurement system. The AMS 3007*i* uses the "propagation time" of the light to calculate the distance to the reflector. The high absolute measurement accuracy of the laser measurement system and the fast integration time are designed for position control applications.



## 2 Safety

This sensor was developed, manufactured and tested in line with the applicable safety standards. It corresponds to the state of the art.

### 2.1 Intended use

The AMS 30xx*i* is an absolute measuring optical laser measurement system which allows distance measurement of up to 200m against a reflector.

#### **Areas of application**

The AMS 30xx*i* is designed for the following areas of application:

- Positioning of automated, moving plant components
- Travel and lifting axes of high-bay storage devices
- Repositioning units
- Gantry crane bridges and their trolleys
- Elevators
- Electroplating plants



#### **CAUTION**

##### **Observe intended use!**

- ↳ Only operate the device in accordance with its intended use. The protection of personnel and the device cannot be guaranteed if the device is operated in a manner not complying with its intended use.  
Leuze electronic GmbH + Co. KG is not liable for damages caused by improper use.
- ↳ Read the technical description before commissioning the device. Knowledge of this technical description is an element of proper use.

#### **NOTICE**

##### **Comply with conditions and regulations!**

- ↳ Observe the locally applicable legal regulations and the rules of the employer's liability insurance association.

## 2.2 Foreseeable misuse

Any use other than that defined under "Intended use" or which goes beyond that use is considered improper use.

In particular, use of the device is not permitted in the following cases:

- Rooms with explosive atmospheres
- For medical purposes

<b>NOTICE</b>
<p><b>Do not modify or otherwise interfere with the device.</b></p> <p> Do not carry out modifications or otherwise interfere with the device.                      The device must not be tampered with and must not be changed in any way.                      The device must not be opened. There are no user-serviceable parts inside.                      Repairs must only be performed by Leuze electronic GmbH + Co. KG.</p>

## 2.3 Competent persons

Connection, mounting, commissioning and adjustment of the device must only be carried out by competent persons.

Prerequisites for competent persons:

- They have a suitable technical education.
- They are familiar with the rules and regulations for occupational safety and safety at work.
- They are familiar with the technical description of the device.
- They have been instructed by the responsible person on the mounting and operation of the device.

### ***Certified electricians***

Electrical work must be carried out by a certified electrician.

Due to their technical training, knowledge and experience as well as their familiarity with relevant standards and regulations, certified electricians are able to perform work on electrical systems and independently detect possible dangers.

In Germany, certified electricians must fulfill the requirements of accident-prevention regulations BGV A3 (e.g. electrician foreman). In other countries, there are respective regulations that must be observed.

## 2.4 Exemption of liability

Leuze electronic GmbH + Co. KG is not liable in the following cases:

- The device is not being used properly.
- Reasonably foreseeable misuse is not taken into account.
- Mounting and electrical connection are not properly performed.
- Changes (e.g., constructional) are made to the device.

## 2.5 Laser safety notices



### ATTENTION LASER RADIATION – LASER CLASS 2

#### Never look directly into the beam!

The device satisfies the requirements of IEC 60825-1:2007 (EN 60825-1:2007) safety regulations for a product in **laser class 2** as well as the U.S. 21 CFR 1040.10 regulations with deviations corresponding to "Laser Notice No. 50" from June 24th, 2007.

- ↖ Never look directly into the laser beam or in the direction of reflecting laser beams. If you look into the beam path over a longer time period, there is a risk of injury to the retina.
- ↖ Do not point the laser beam of the device at persons!
- ↖ Interrupt the laser beam using a non-transparent, non-reflective object if the laser beam is accidentally directed towards a person.
- ↖ When mounting and aligning the device, avoid reflections of the laser beam off reflective surfaces!
- ↖ CAUTION! The use of operating or adjusting devices other than those specified here or carrying out of differing procedures may lead to dangerous exposure to radiation.
- ↖ Observe the applicable statutory and local laser protection regulations.
- ↖ The device must not be tampered with and must not be changed in any way. There are no user-serviceable parts inside the device. Repairs must only be performed by Leuze electronic GmbH + Co. KG.

### NOTICE

#### Affix laser information and warning signs!

Laser information and warning signs are attached to the device (see figure 2.1):

In addition, self-adhesive laser warning and information signs (stick-on labels) are supplied in several languages (see figure 2.2).

- ↖ Affix the laser information sheet to the device in the language appropriate for the place of use. When using the device in the U.S.A., use the stick-on label with the "Complies with 21 CFR 1040.10" notice.
- ↖ Affix the laser information and warning signs near the device if no signs are attached to the device (e.g., because the device is too small) or if the attached laser information and warning signs are concealed due to the installation position. Affix the laser information and warning signs so that they are legible without exposing the reader to the laser radiation of the device or other optical radiation.

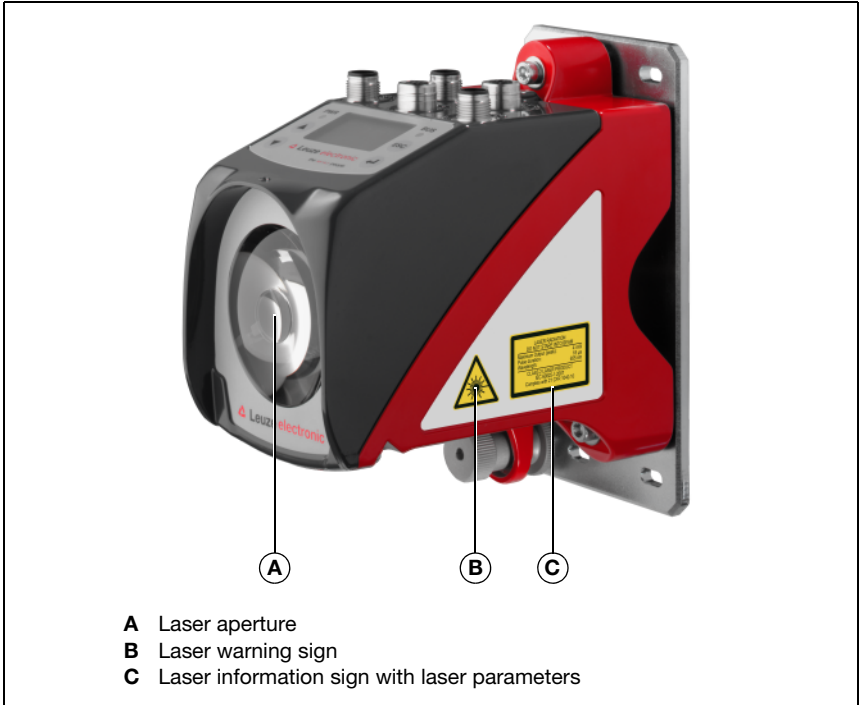

Figure 2.1: Laser apertures, laser warning signs

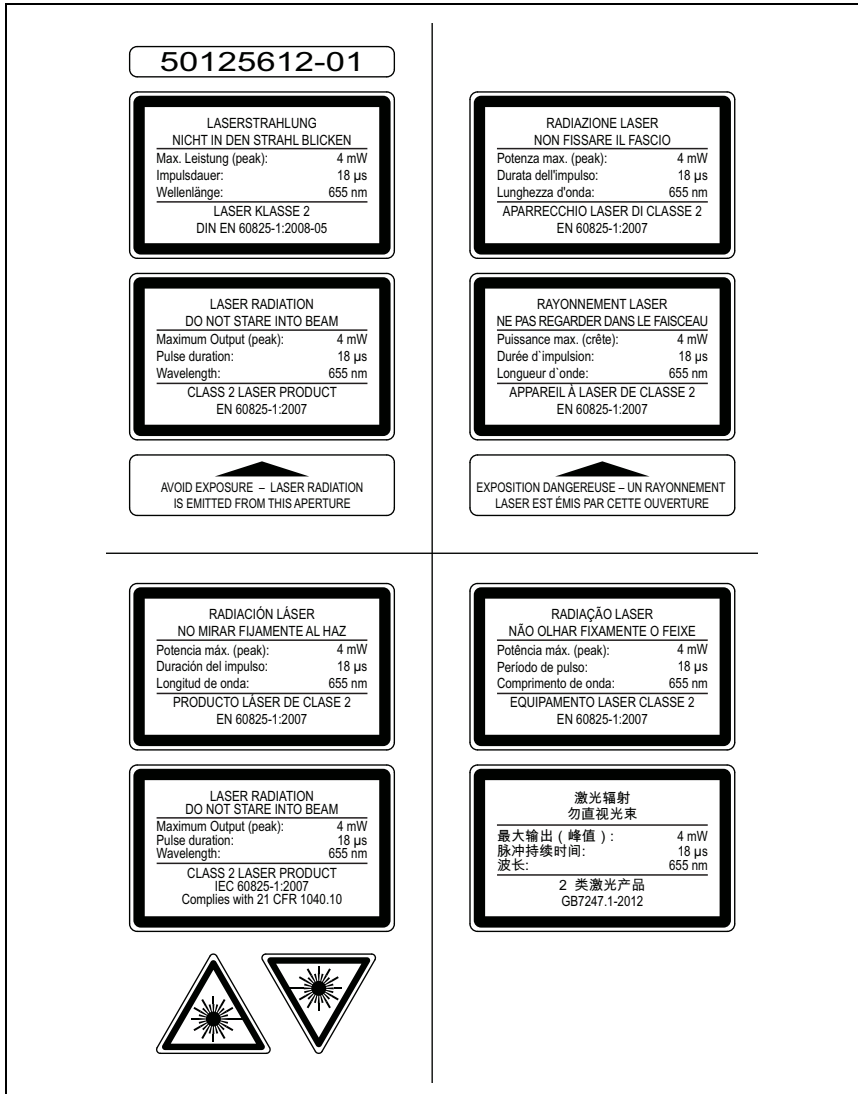

Figure 2.2: Laser warning and information signs – supplied stick-on labels

### 3 Fast commissioning / operating principle

**Notice!**

Below, you will find a **short description of the initial commissioning** of the AMS 3007*i*. Detailed explanations of the listed points can be found throughout the handbook.

#### 3.1 Mounting the AMS 3007*i*

The AMS 3007*i* and the corresponding reflector are mounted on two mutually opposing, plane-parallel, flat walls.

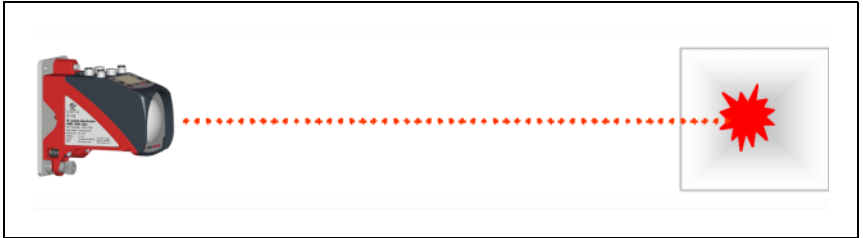

Figure 3.1: Schematic illustration of mounting

**Attention!**

For error-free position measurement, there must be an unobstructed line-of-sight between the AMS 3007*i* and the reflector.

##### 3.1.1 Mounting the device

The laser is mounted using 4 screws (M5).

Alignment is performed using 2 adjustment screws. Adjust so that the laser light spot is positioned at the center of the reflector. The alignment is to be secured with the knurled nut and locked with the M5 nut.

**Further information can be found in chapter 5.2 and chapter 5.3.**

##### 3.1.2 Mounting the reflector

The reflector is mounted using 4 screws (M5). The reflector is angled using the spacer sleeves included. Incline the reflector by approx. 1°.

**Detailed information can be found in chapter 6.4.**



### 3.2 Connecting the voltage supply

The laser measurement system is connected using M12 connectors. The voltage supply is connected via the PWR M12 connection.

**Detailed information can be found in chapter 7.**

### 3.3 Display

Once the laser measurement system is supplied with voltage, the device status as well as the measured position values can be read on the display. The display automatically switches to the display of the measurement values.

Use the up/down buttons   to the left of the display to read and change a wide range of data and parameters.

**Detailed information can be found in chapter 8.**

### 3.4 SSI interface

For correct data exchange between frequency inverter and AMS 3007*i*, both devices must have the same settings for the following parameters.

- Coding
- Number of data bits
- Resolution
- Error bit on/off

**For further information, see also chapter 9 "SSI interface" on page 52 and display menu structure level 2, menu item "SSI" in the appendix of the manual.**

## 4 Technical data

### 4.1 Specifications of the laser measurement system

#### 4.1.1 General specifications AMS 3007*i*

Measurement data	AMS 3007 <i>i</i> 40	AMS 3007 <i>i</i> 120	AMS 3007 <i>i</i> 200
Measurement range	0.2 ... 40 m	0.2 ... 120 m	0.2 ... 200 m
Accuracy	± 2 mm	± 2 mm	± 3 mm
Consistency <sup>1)</sup>	0.3 mm	0.5 mm	0.7 mm
Light spot diameter	≤ 40 mm	≤ 100 mm	≤ 150 mm
Measurement value output		1.7 ms	
Integration time		8 ms	
Resolution	adjustable, see chapter 9 "SSI interface"		
Temperature drift		≤ 0.1 mm/K	
Ambient temperature sensitivity		1 ppm/K	
Air pressure sensitivity		0.3 ppm/hPa	
Traverse rate		≤ 10 m/s	
<b>Electrical data</b>			
Supply voltage $V_{in}$		18 ... 30VDC	
Current consumption		≤ 250 mA / 24VDC	
<b>Optical data</b>			
Transmitter		laser diode, red light	
Laser class	2 in accordance with IEC 60825-1:2007, CDRH		
Wavelength		655 nm	
Impulse duration		18 μs	
Max. output power (peak)		4 mW	
<b>Interfaces</b>			
SSI clock rate		50 kHz ... 800 kHz	
<b>Operating and display elements</b>			
Keyboard		4 buttons	
Display	monochromatic graphical display, 128 x 64 pixels		
LED		2 LEDs, two-colored	



Inputs/outputs

Quantity	2, programmable
Input	protected against polarity reversal
Output	max. 60mA, short-circuit proof

**Mechanical data**

Housing	cast zinc and aluminum
Optics	glass
Weight	approx. 2.45kg
Degree of protection	IP 65 acc. to EN 60529 <sup>2)</sup>

**Environmental conditions**

Operating temperature	-5°C ... +50°C
Storage temperature	-30°C ... +70°C
Air humidity	max. 90% rel. humidity, non-condensing

**Mechanical/electrical loading capacity**

Vibration	acc. to EN 60068-2-6
Noise	acc. to EN 60060-2-64
Shock	acc. to EN 60068-2-27
EMC	acc. to EN 61000-6-2 and EN 61000-6-4 <sup>3)</sup>

- 1) Statistical error: 1 sigma; minimum switch-on time: 2 min.
- 2) With screwed-on M12 plugs or mounted caps.
- 3) This is a Class A product. In a domestic environment this product may cause radio interference, in which case the operator may be required to take adequate measures.



The AMS 3007*i* is designed in accordance with safety class III for supply with PELV (protective extra-low voltage).

**4.1.2 Dimensioned drawing AMS 3007*i***

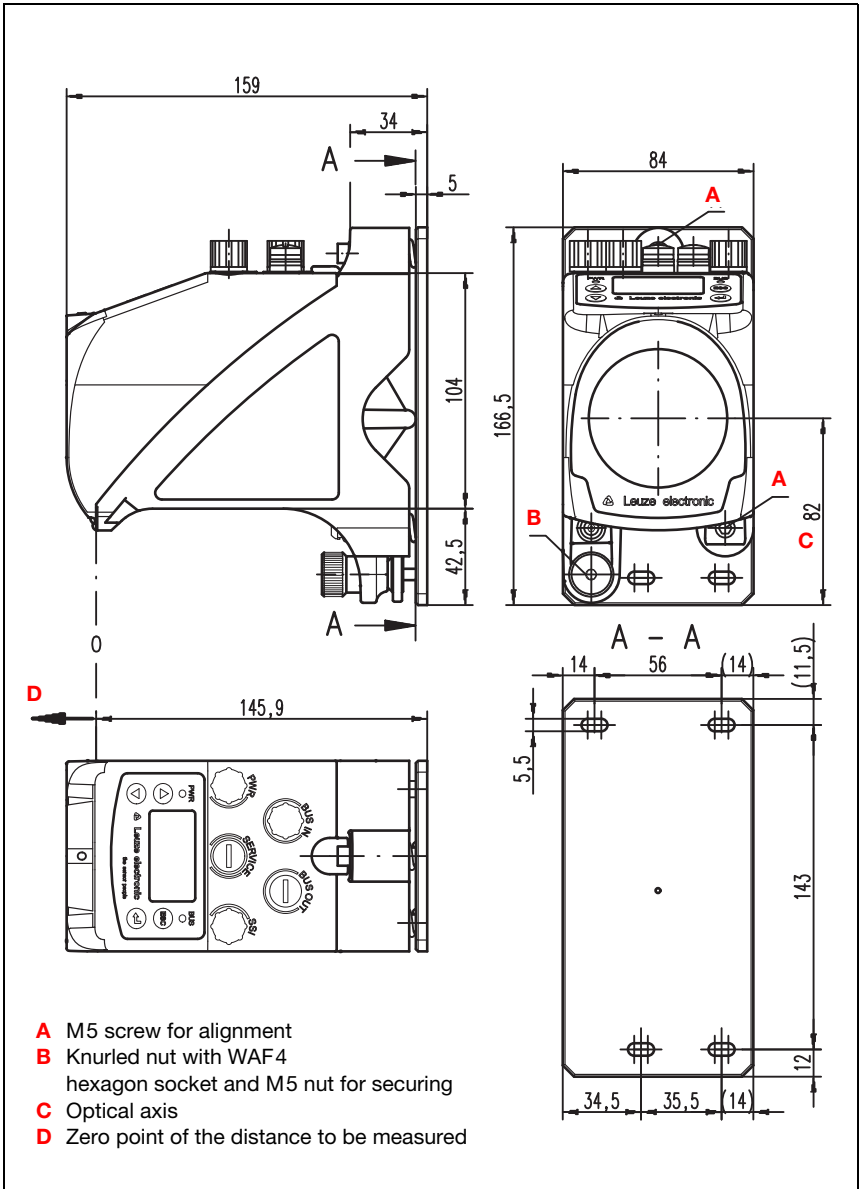

Figure 4.1: Dimensioned drawing AMS 3007*i*

4.1.3 Type overview AMS 3007*i*

**AMS 3007*i***

Type designation	Description	Part no.
AMS 3007 <i>i</i> 40	40m operating range, SSI interface	50130196
AMS 3007 <i>i</i> 120	120m operating range, SSI interface	50130197
AMS 3007 <i>i</i> 200	200m operating range, SSI interface	50130198

Table 4.1: Type overview AMS 3007*i*

## 5 Installation and mounting

### 5.1 Storage, transportation



**Attention!**

Package the device for transport and storage in such a way that is protected against shock and humidity. The original packaging offers optimum protection. Heed the required environmental conditions specified in the technical data.

**Unpacking**

- ↪ Check the packaging for any damage. If damage is found, notify the post office or shipping agent as well as the supplier.
- ↪ Check the delivery contents using your order and the delivery papers:
  - Delivered quantity
  - Device type and model as indicated on the name plate
  - Brief manual

The name plate provides information as to what AMS 3007*i* type your device is. For specific information, please refer to chapter 11.2.

**Name plates**

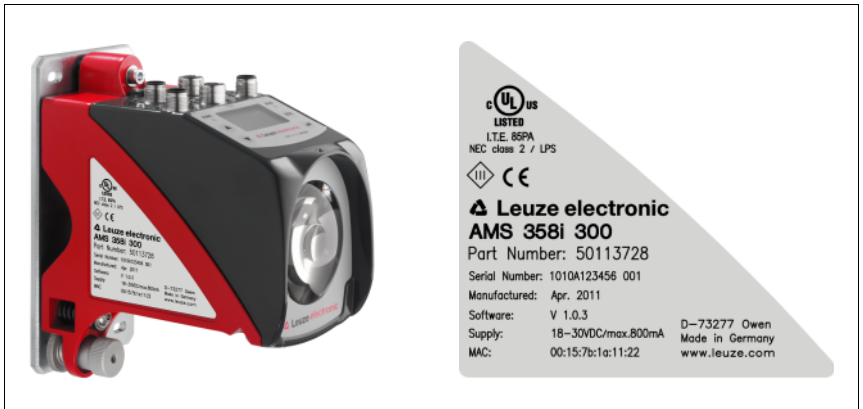

Figure 5.1: Device name plate using the AMS 358i as an example



**Notice!**

Please note that the shown name plate is for illustration purposes only; the contents do not correspond to the original.

- ↪ Save the original packaging for later storage or shipping.

If you have any questions concerning your shipment, please contact your supplier or your local Leuze electronic sales office.

 Observe the applicable local regulations when disposing of the packaging materials.

## 5.2 Mounting the AMS 3007*i*

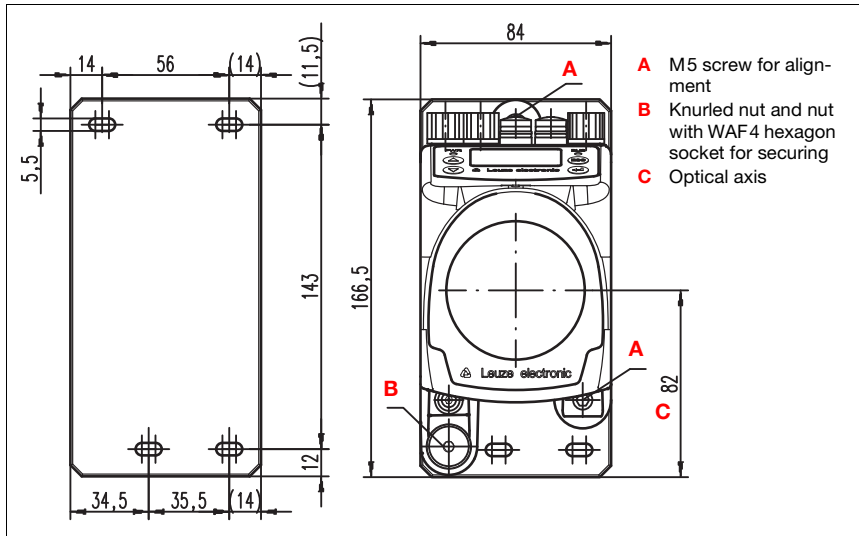

Figure 5.2: Mounting the device

The AMS 3007*i* and the corresponding reflector are mounted on two mutually opposing, plane-parallel, flat walls or system parts. For error-free position measurement, there must be an unobstructed line-of-sight connection between the AMS 3007*i* and the reflector.

Use M5 screws to fasten the laser measurement system. Secure the screws with a toothed lock washer to protect against loosening caused by vibrations.

***Aligning the laser light spot in the center of the reflector***

The laser light spot has to be aligned so that it always hits the center of the opposing reflector, both at close range as well as at the maximum measurement distance. **To align, use the two M5 Allen screws** ("A" in figure 5.2). When aligning please ensure that the knurled nut and the lock nut ("B" in figure 5.2) are opened wide.

***Attention!***

*To prevent the laser measurement system from moving out of alignment during continuous operation, subsequently hand-tighten the knurled nut and counterlock with the nut with WAF4 hexagon socket ("B" in figure 5.2). Knurled nut and nut must not be tightened until alignment has been completed.*

***Attention!***

*The device must not be opened. Failure to comply will render the guarantee void. Warranted features cannot be guaranteed after the device has been opened.*

### 5.2.1 Optional mounting bracket

A mounting bracket for mounting the AMS 3007*i* on a flat, horizontal surface is available as an optional accessory.

Type designation: MW OMS/AMS 01

Part no.: 50107255

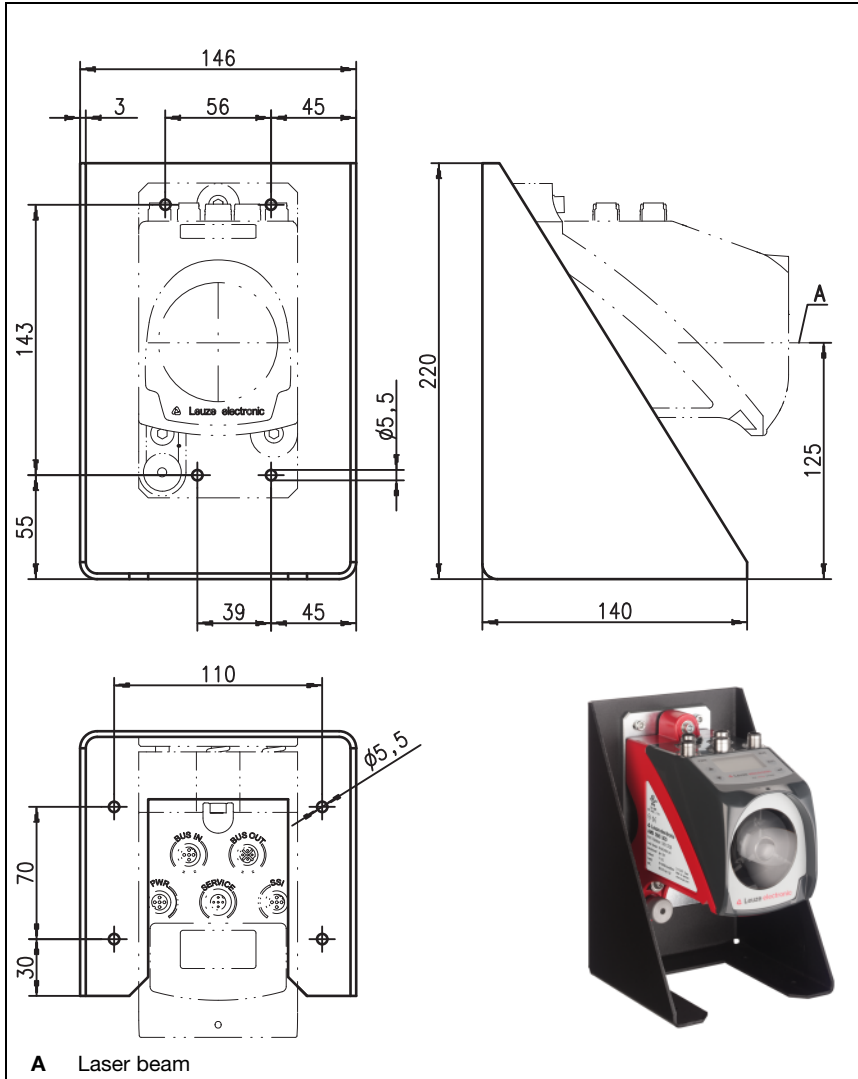

Figure 5.3: Optional mounting bracket

5.2.2 Parallel mounting of the AMS 3007*i*

**Definition of the term "parallel spacing"**

As shown in figure 5.4, dimension X describes the "parallel spacing" of the inner edges of the two laser light spots on the reflector.

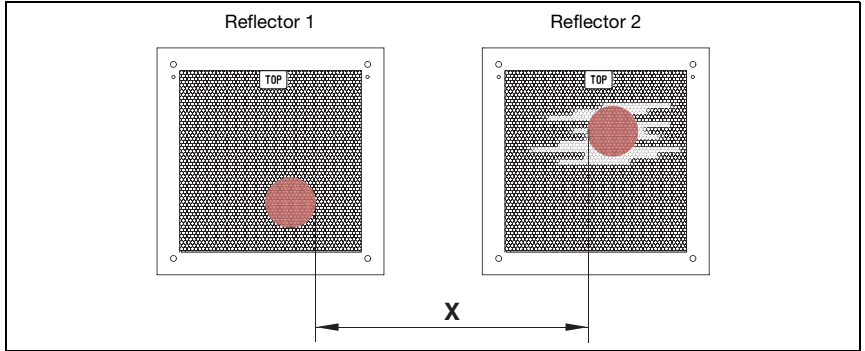

Figure 5.4: Minimum parallel spacing X between adjacent AMS 3007*i*

The diameter of the light spot increases with distance.

	AMS 3007 <i>i</i> 40	AMS 3007 <i>i</i> 120	AMS 3007 <i>i</i> 200
Max. measurement distance	40m	120m	200m
Light spot diameter	≤ 40mm	≤ 100mm	≤ 150mm

Thus, the center-to-center spacing of the two AMS 3007*i* devices with respect to one another can be calculated as a function of the maximum measurement distance.

To define the minimum parallel spacing between two AMS 3007*i*, it is necessary to distinguish between three different arrangements of AMS 3007*i* and reflectors.

**The AMS 3007*i* are mounted stationary and in parallel on one plane. Both reflectors move independently of one another at different distances to the AMS 3007*i*.**

Minimum parallel spacing X of the two laser light spots:

$$X = 100\text{mm} + (\text{max. measurement distance in mm} \times 0.01)$$

**The AMS 3007*i* are mounted stationary and in parallel on one plane. Both reflectors move in parallel at the same distance to the AMS 3007*i*.**

Measurement distance up to 120m: minimum parallel spacing X ≥ 600mm

Measurement distance up to 200m: minimum parallel spacing X ≥ 750mm



***The reflectors are mounted stationary and in parallel on one plane.***

***Both AMS 3007*i* move independently of one another at different or the same distances to the reflectors.***

Measurement distance **up to 120m**: minimum parallel spacing **X ≥ 600mm**

Measurement distance **up to 200m**: minimum parallel spacing **X ≥ 750mm**



**Notice!**

*Please note that when the AMS 3007*i* are mounted in a mobile manner, travel tolerances could cause the two laser light spots to move towards each other.*

*Take the travel tolerances of the vehicle into account when defining the parallel spacing of adjacent AMS 3007*i*.*

### 5.2.3 Parallel mounting of AMS 3007*i* and DDLS optical data transmission

The optical data transceivers of the DDLS series and the AMS 3007*i* do not interfere with one another. Depending on the size of the used reflector, the DDLS can be mounted with a minimum parallel spacing of 100mm to the AMS 3007*i*. The parallel spacing is independent of the distance.

### 5.3 Mounting the AMS 3007*i* with laser beam deflector unit

#### General information

The two available deflector units are used for the 90° deflection of the laser beam, see "Accessory deflector unit" on page 61.



#### Attention!

The deflector units are designed for a maximum range of 40m. Longer distances on request.

#### 5.3.1 Mounting the laser beam deflector unit with integrated mounting bracket

The AMS 3007*i* is screwed onto the mechanism of the US AMS 01 deflector unit. The mirror can be mounted for three deflection directions:

1. Upward beam deflection
2. Beam deflection to the left
3. Beam deflection to the right

The deflector unit is mounted on plane-parallel, flat walls or plant components. For error-free position measurement, there must be an interruption-free line-of-sight between the AMS 3007*i*... and the deflection mirror as well as between the mirror and the reflector.

Use the M5 screws to mount the deflector unit. Secure the screws with a toothed lock washer to protect against loosening caused by vibrations.

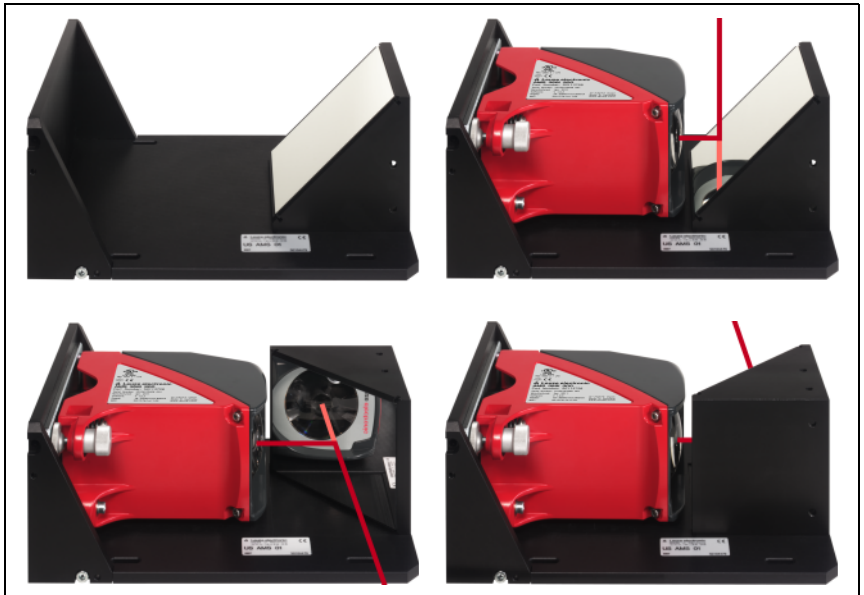

Figure 5.5: Mounting variants of the US AMS 01 laser beam deflector unit

5.3.2 Dimensioned drawing of US AMS 01 deflector unit

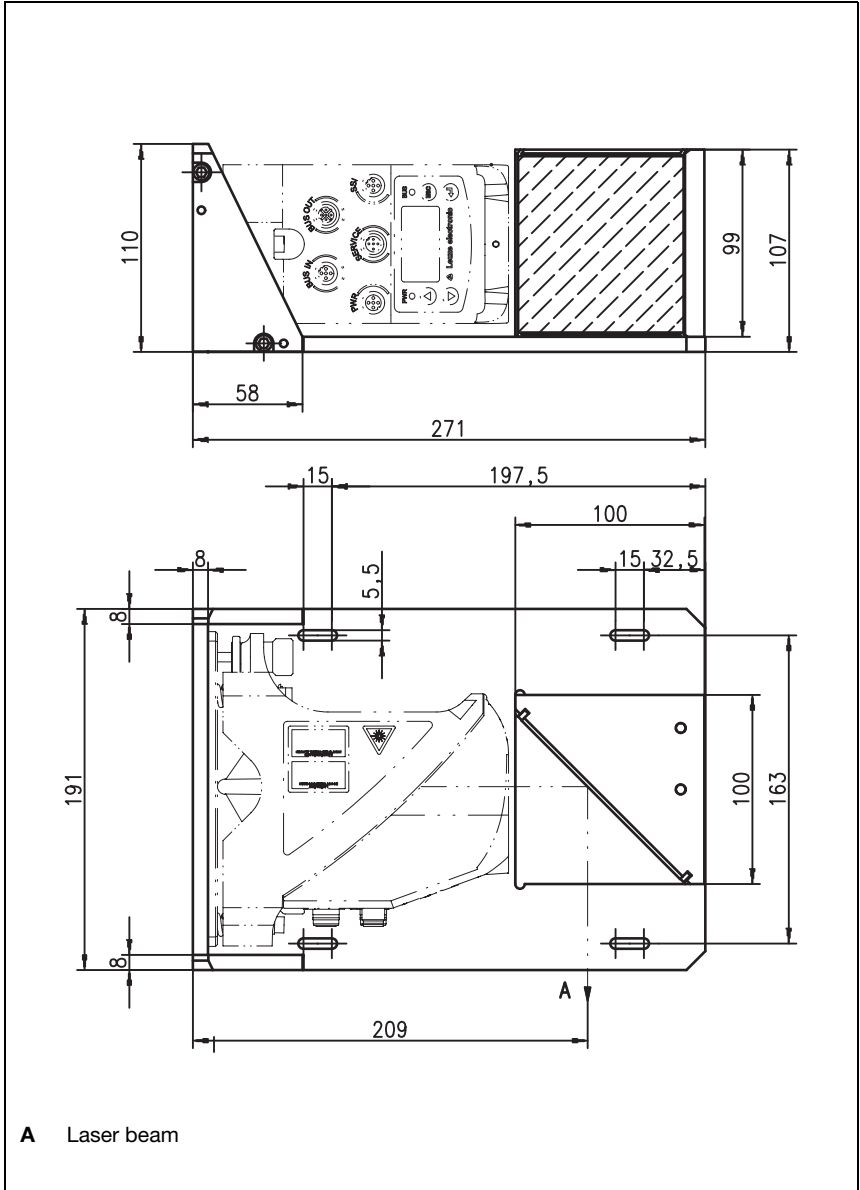

Figure 5.6: Dimensioned drawing of US AMS 01 deflector unit

5.3.3 Mounting the US 1 OMS deflector unit without mounting bracket

The US 1 OMS deflector unit and the AMS 3007*i* are mounted separately.



**Notice!**

When mounting, make certain that the laser light spot of the AMS 3007*i* is aligned in the center of the deflection mirror.

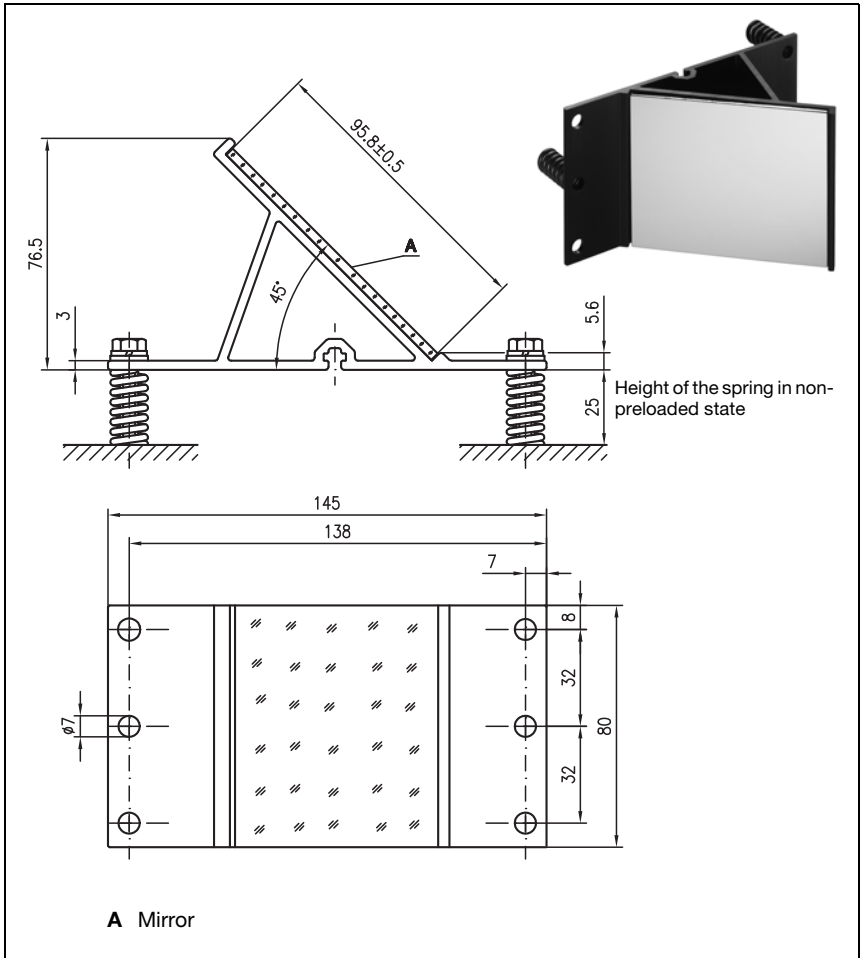

Figure 5.7: Photo and dimensioned drawing of the US 1 OMS deflector unit

Alignment of the laser light spot on the reflector is performed as described in chapter 5.2.

## 6 Reflectors

### 6.1 General information

The AMS 3007*i* measures distances against a reflective tape specified by Leuze electronic. All provided specifications for the AMS 3007*i*, such as the operating range or accuracy, can only be achieved with the reflective tape specified by Leuze electronic.

The reflective tapes are available as adhesive tapes, affixed to a metal plate and with an integrated heater especially for use at low temperatures. Reflective tapes with heating have the designation "**Reflective tape ...x...-H**", where "**H**" is an abbreviation for the heating variant.

The reflective tapes/reflectors must be ordered separately. The choice of size is left to the user. In chapter 6.3, recommendations on reflector size are provided as a function of the distance that is to be measured. In any case, the user must check to determine whether the recommendation is suitable for the respective application.

### 6.2 Description of the reflective tape

The reflective tape consists of a white, microprism-based reflective material. The microprisms are protected with a highly transparent, hard protective layer.

Under certain circumstances, the protective layer may lead to surface reflections. The surface reflections can be directed past the AMS 3007*i* by positioning the reflective tape at a slight incline. The inclination of the reflective tape/reflectors is described in chapter 6.4.2. The required pitch can be found in table 6.1 "Reflector pitch resulting from spacer sleeves" on page 35.

The reflective tapes are provided with a protective foil that can easily be pulled off. This must be removed from the reflector before the complete system is put into operation.

**6.2.1 Specifications of the self-adhesive foil**

	<b>Part</b>		
Type designation	<b>Reflective tape 200x200-S</b>	<b>Reflective tape 500x500-S</b>	<b>Reflective tape 914x914-S</b>
Part no.	50104361	50104362	50108988
Foil size	200x200mm	500x500mm	914x914mm
Recommended application temperature for adhesive tape	+5°C ... +25°C		
Temperature resistance, affixed	-40°C ... +80°C		
Mounting surface	The mounting surface must be clean, dry and free of grease.		
Cutting the tape	Cut with a sharp tool, always on the side of the prism structure.		
Cleaning	Do not use any agents that act with a grinding effect. A conventional household detergent can be used as a cleaning agent. Rinse with clear water and dry the surface.		
Storing the foil	Store in a cool and dry place.		

**6.2.2 Specifications of the reflective tape on a metal plate**

The reflective tape is affixed to a metal plate. Included with the metal plate are spacers for positioning at an incline - for avoiding surface reflections - (see chapter 6.4.2 "Mounting the reflector").

	<b>Part</b>		
Type designation	<b>Reflective tape 200x200-M</b>	<b>Reflective tape 500x500-M</b>	<b>Reflective tape 914x914-M</b>
Part no.	50104364	50104365	50104366
Foil size	200x200mm	500x500mm	914x914mm
Outer dimensions of the metal plate	250x250mm	550x550mm	964x964mm
Weight	0.8kg	4kg	25kg
Cleaning	Do not use any agents that act with a grinding effect. A conventional household detergent can be used as a cleaning agent. Rinse with clear water and dry the surface.		
Storing the reflector	Store in a cool and dry place.		

6.2.3 Dimensioned drawing of reflective tape on a metal plate

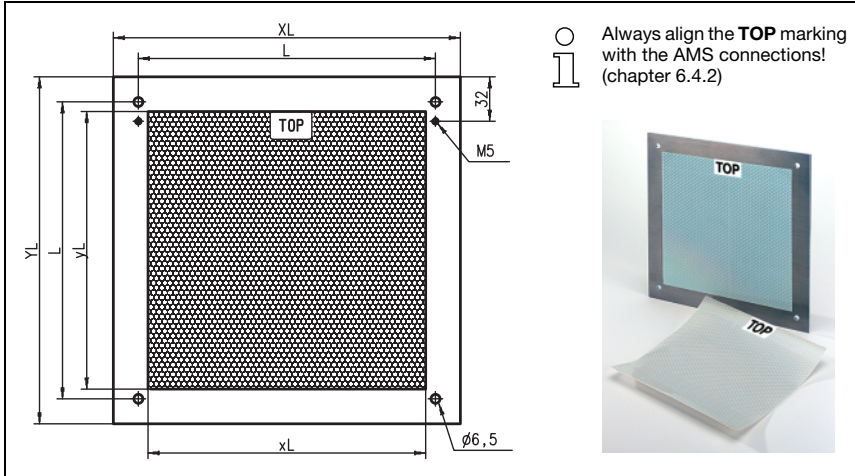

Figure 6.1: Dimensioned drawing of reflectors

Part	Reflective tape (mm)		Reflector plate (mm)		
	xL	yL	XL	YL	L
Reflective tape 200x200-M	200	200	250	250	214
Reflective tape 500x500-M	500	500	550	550	514
Reflective tape 914x914-M	914	914	964	964	928

**6.2.4 Specifications of heated reflectors**

The reflective tape is affixed to a heated, thermally insulated base. The insulation results in a very high energetic efficiency.

Only the reflective tape is kept at the specified temperature by the integrated heater. Through the insulation on the back, the generated heat cannot be transferred via the steel construction. Energy costs are greatly reduced in the case of continuous heating.

	<b>Part</b>		
Type designation	<b>Reflective tape 200x200-H</b>	<b>Reflective tape 500x500-H</b>	<b>Reflective tape 914x914-H</b>
Part no.	50115020	50115021	50115022
Voltage supply	230VAC		
Power	100W	600W	1800W
Current consumption	~ 0.5A	~ 3A	~ 8A
Length of the supply line	2 m		
Size of the reflective tape	200x200mm	500x500mm	914x914mm
Outer dimensions of the base material	250x250mm	550x550mm	964x964mm
Weight	0.5kg	2.5kg	12kg
Temperature control	Controlled heating with the following switch-on and switch-off temperatures, measured at the reflector surface.		
Switch-on temperature	~ 5°C		
Switch-off temperature	~ 20°C		
Operating temperature	-30°C ... +70°C		
Storage temperature	-40°C ... +80°C		
Air humidity	Max. 90%, non-condensing.		
Cleaning	Do not use any agents that act with a grinding effect. A conventional household detergent can be used as a cleaning agent. Rinse with clear water and dry the surface.		
Storing the reflector	Store in a cool and dry place.		



**6.2.5 Dimensioned drawing of heated reflectors**

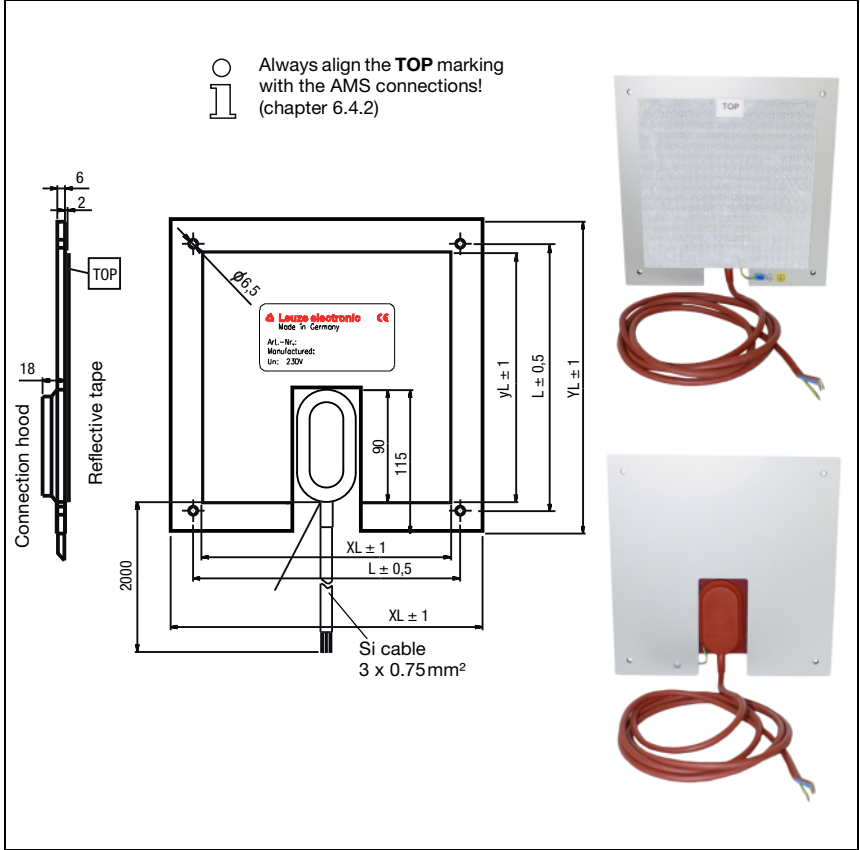

Figure 6.2: Dimensioned drawing of heated reflectors

Part	Reflective tape (mm)		Insulated base plate (mm)		
	xL	yL	XL	YL	L
Reflective tape 200x200-H	200	200	250	250	214
Reflective tape 500x500-H	500	500	550	550	514
Reflective tape 914x914-H	914	914	964	964	928

### 6.3 Selecting reflector sizes

Depending on system design, the reflector can be mounted so that it travels on the vehicle or it can be mounted at a fixed location.



**Attention!**

The reflector sizes shown below are a recommendation from Leuze electronic for on-vehicle mounting of the AMS 3007*i*. For stationary mounting of the AMS 3007*i*, a smaller reflector is generally sufficient for all measurement distances.

On the basis of the system planning and design, always check whether mechanical travel tolerances may require the use of a reflector larger than that which is recommended. This applies, in particular, when the laser measurement system is mounted on a vehicle. During travel, the laser beam must reach the reflector without interruption. For on-vehicle mounting of the AMS 3007*i*, the reflector size must accommodate any travel tolerances that may arise and the associated "wandering" of the light spot on the reflector.

**Overview of reflector types**

Recommended reflector sizes			
AMS 3007 <i>i</i> selection (Operating range in m)	Recommended reflector size (H x W)	Type designation ...-S = Self-adhesive ...-M = metal plate ...-H = heating	Part no.
AMS 3007 <i>i</i> 40 (max. 40m)	200x200mm	Reflective tape 200x200-S Reflective tape 200x200-M Reflective tape 200x200-H	50104361 50104364 50115020
AMS 3007 <i>i</i> 120 (max. 120m)	500x500mm	Reflective tape 500x500-S Reflective tape 500x500-M Reflective tape 500x500-H	50104362 50104365 50115021
AMS 3007 <i>i</i> 200 (max. 200m)	749x914mm 914x914mm	Reflective tape 749x914-S Reflective tape 914x914-M Reflective tape 914x914-S Reflective tape 914x914-H	50104363 50104366 50108988 50115022

## 6.4 Mounting the reflector

### 6.4.1 General information

#### **Self-adhesive reflective tapes**

The reflective tapes of the "Reflective tape ...x...-S" self-adhesive series must be affixed to a flat, clean and grease-free surface. We recommend using a separate metal plate, which is to be provided on-site.

As described in table 6.1, the reflective tape must be angled.

#### **Reflective tapes on metal**

The reflective tapes of the "Reflective tape ...x...-M" series are provided with corresponding mounting holes. Spacer sleeves are provided in the packet for achieving the necessary pitch angle. For further information see table 6.1.

#### **Heated reflectors**

The reflective tapes of the "Reflective tape ...x...-H" series are provided with corresponding mounting holes. Due to the voltage supply affixed on the rear, the reflector cannot be mounted flat. Included in the package are four distance sleeves in two different lengths. Use the distance sleeves to achieve a base separation to the wall as well as the necessary pitch for avoiding surface reflection. For further information see table 6.1.

The reflector is provided with a 2m-long connection cable for supplying with 230VAC. Connect the cable to the closest power outlet. Observe the current consumptions listed in the specifications.



#### **Attention!**

*Connection work must be carried out by a certified electrician.*

### 6.4.2 Mounting the reflector

The combination of laser measurement system and reflective tape/reflector is mounted so that the laser light spot hits the tape as centered as possible and without interruption.

For this purpose, use the alignment elements provided on the AMS 3007*i*... (see chapter 5.2 "Mounting the AMS 3007*i*"). If necessary, remove the protective foil from the reflector.



#### **Attention!**

The "TOP" label mounted on the reflectors should be aligned the same as the connections of the AMS 3007*i*.

#### **Example:**

*If the AMS 3007*i* is mounted so that the M12 connections are on the top, the "TOP" label of the reflector is also on the top. If the AMS 3007*i* is mounted so that the M12 connections are on the side, the "TOP" label of the reflector is also on the side.*



**Notice!**

The reflector must be angled. To do this, use the spacer sleeves. Angle the reflectors so that the surface reflections of the foil seal are deflected to the left, right or upwards. chapter 6.4.3 gives the correct pitch with respect to the reflector size and, thus, the length of the spacers.

**Reflective tapes ...-S and ...-M**

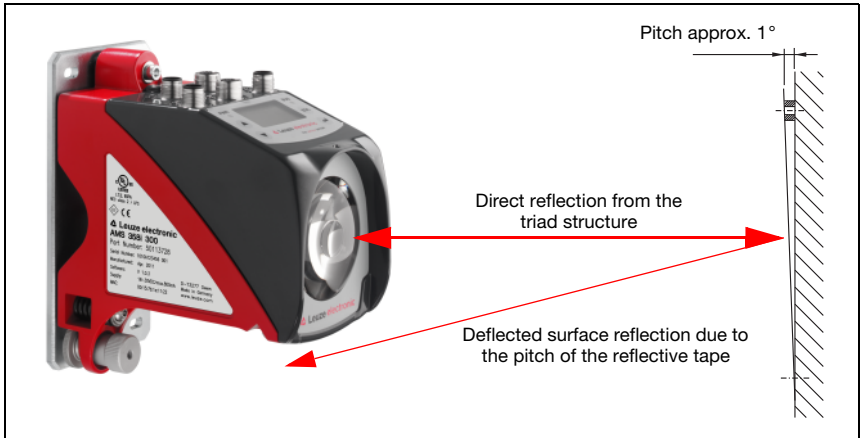

Figure 6.3: Mounting the reflector

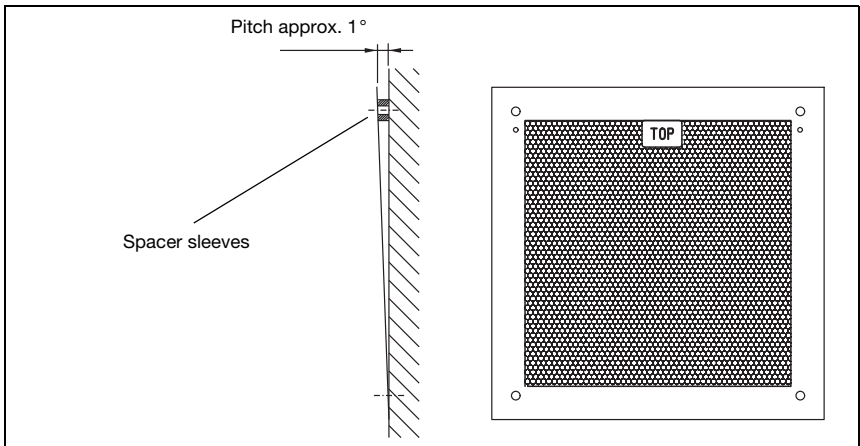

Figure 6.4: Pitch of the reflector

**Reflective tapes ...-H**

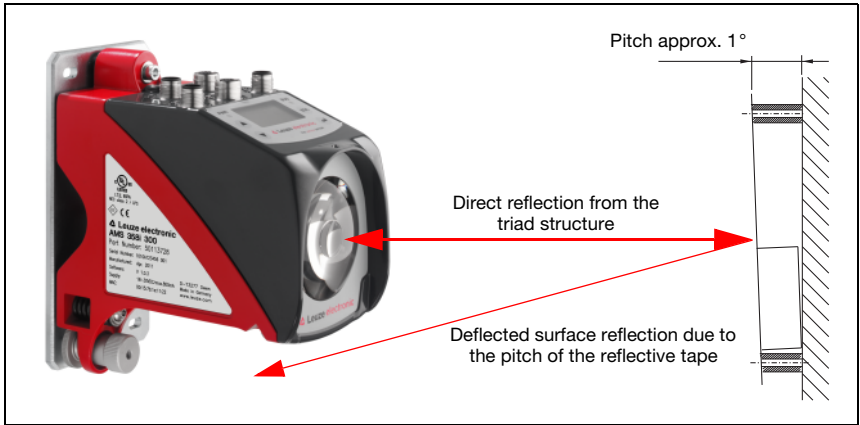

Figure 6.5: Mounting of heated reflectors

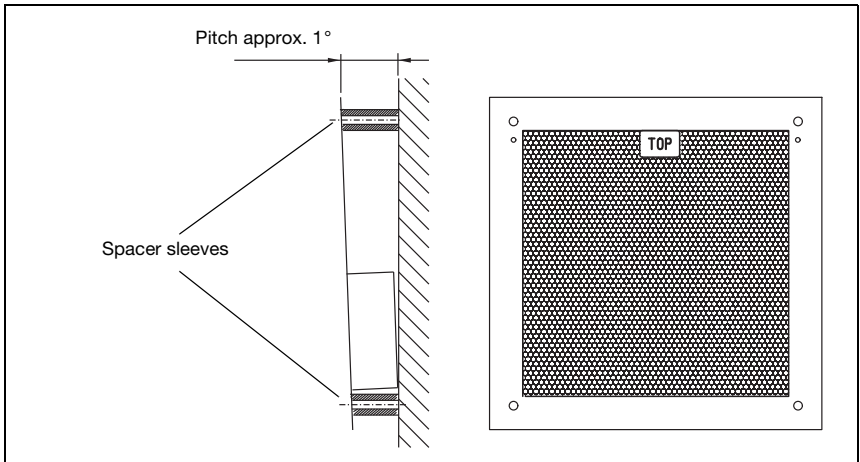

Figure 6.6: Pitch of the heated reflector

**6.4.3 Table of reflector pitches**

<b>Reflector type</b>	<b>Pitch resulting from spacer sleeves <sup>1)</sup></b>	
Reflective tape 200x200-S Reflective tape 200x200-M	<b>2 x 5mm</b>	
Reflective tape 200x200-H	<b>2 x 15mm</b>	<b>2 x 20mm</b>
Reflective tape 500x500-S Reflective tape 500x500-M	<b>2 x 10mm</b>	
Reflective tape 500x500-H	<b>2 x 15mm</b>	<b>2 x 25mm</b>
Reflective tape 749x914-S	<b>2 x 20mm</b>	
Reflective tape 914x914-S Reflective tape 914x914-M	<b>2 x 20mm</b>	
Reflective tape 914x914-H	<b>2 x 15mm</b>	<b>2 x 35mm</b>

1) Spacer sleeves are included in the delivery contents of reflective tape ...-M and ...-H

Table 6.1: Reflector pitch resulting from spacer sleeves



**Notice!**

*Reliable function of the AMS 3007i and, thus, max. operating range and accuracy can only be achieved with the reflective tape specified by Leuze electronic. No function can be guaranteed if other reflectors are used!*

## 7 Electrical connection

The AMS 3007*i* laser measurement systems are connected using variously coded M12 connectors. This ensures unique connection assignments.



### Notice!

The corresponding mating connectors and ready-made cables are available as accessories for all cables. For further information, see chapter 11 "Type overview and accessories".



Figure 7.1: Connections of the AMS 3007*i*

### 7.1 Safety notices for the electrical connection



#### Attention!

Before connecting the device, be sure that the supply voltage agrees with the value printed on the name plate.

The device may only be connected by a qualified electrician.

Ensure that the functional earth (FE) is connected correctly. Unimpaired operation is only guaranteed when the functional earth is connected properly.

If faults cannot be corrected, the device should be removed from operation and protected against possible use.



The laser measurement systems are designed in accordance with safety class III for supply by PELV (protective extra-low voltage with reliable disconnection).



### Notice!

Degree of protection IP65 is achieved only if the connectors and caps are screwed into place!

Described in detail in the following are the individual connections and pin assignments.

### 7.2 PWR – voltage supply / switching input/output

PWR (5-pin plug, A-coded)			
	Pin	Name	Remark
	1	VIN	Positive supply voltage +18 ... +30VDC
	2	I/O 1	Switching input/output 1
	3	GND	Negative supply voltage 0VDC
	4	I/O 2	Switching input/output 2
	5	FE	Functional earth
Thread	FE	Functional earth (housing)	

Table 7.1: PWR pin assignment

Further information on configuring the input/output can be found in display menu structure level 2, menu item "I/O" in the appendix of the manual.

### 7.3 SSI

SSI (5-pin plug, B-coded)			
	Pin	Name	Remark
	1	DATA+	+ Data line SSI (output)
	2	DATA-	- Data line SSI (output)
	3	CLK+	+ Clock line SSI (input electrically insulated)
	4	CLK-	- Clock line SSI (input electrically insulated)
	5	FE	Functional earth
Thread	FE	Functional earth (housing)	

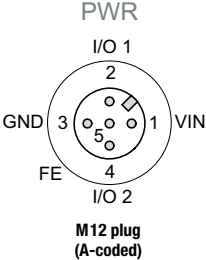
Table 7.2: SSI pin assignment



## 7.4 Service

Service (5-pin socket, A-coded)			
	Pin	Name	Remark
 <p> <b>SERVICE</b>            RS232-TX            2            NC 1 3 GND            4 NC            RS232-RX            5  <b>M12 socket</b>  <b>(A-coded)</b> </p>	1	NC	Not used
	2	RS232-TX	Transmission line RS 232/service data
	3	GND	Voltage supply 0VDC
	4	RS232-RX	Receiving line RS 232/service data
	5	NC	Not used
	Thread	FE	Functional earth (housing)

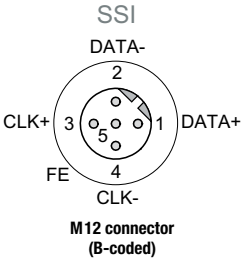
Table 7.3: Service pin assignment



### **Notice!**

*The service interface is designed only for use by Leuze electronic!*

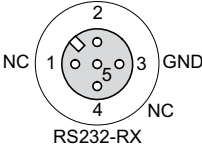
## 8 Display and control panel AMS 3007i

### 8.1 Structure of the control panel

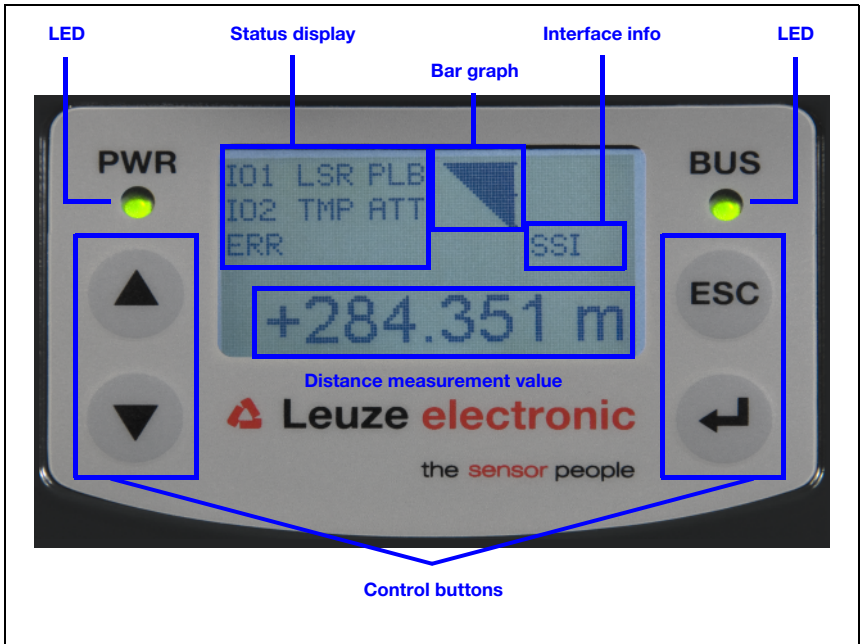

Figure 8.1: Structure of the control panel

### 8.2 Status display and operation

#### 8.2.1 Indicators in the display

##### *Status and warning messages in the display*

- I01 **Input 1 or output 1 active:**  
Function depending on configuration.
- I02 **Input 2 or output 2 active:**  
Function depending on configuration.
- LSR **Warning - laser prefailure message:**  
Laser diode old, device still functional, exchange or have repaired.
- TMP **Warning - temperature monitoring:**  
Permissible internal device temperature exceeded / not met.

- PLB **Plausibility error:**  
Implausible measurement value. Possible causes: light beam interruption, outside of measurement range, permissible internal device temperature considerably exceeded or traverse rate >10m/s.  
Depending on the configuration, either zero or the last valid measurement value is output at the interfaces.
- ATT **Warning received signal:**  
Laser outlet window or reflector soiled or fogged by rain, water vapor or fog. Clean or dry surfaces.
- ERR **Internal hardware error:**  
The device must be sent in for inspection.

**Bar graph**



Indicates the **strength of the received laser light**.  
The center bar represents the **ATT** warning threshold. The distance value remains valid and is output at the interfaces.  
If no bar graph is available, the **PLB** status information appears at the same time. The measurement value has thus been assessed as being implausible. Depending on the configuration, either zero or the last valid measurement value is output at the interfaces.

**Interface info**

The abbreviation "SSI" stands for the activated SSI interface.

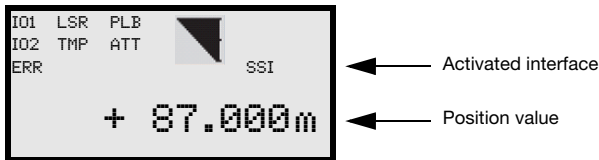

**Position value**

- The measured position value is displayed in the configured unit of measurement.
- +87.000m With the **metric** setting, the measurement value is always displayed in meters with **three decimal places**.
  - +87.0in With the **inch** setting, the measurement value is always displayed in inches with **one decimal place**.

### 8.2.2 LED status displays

#### **PWR LED**

PWR



**Off**

**Device OFF**

- No supply voltage

PWR



**Flashing green**

**Power LED flashes green**

- No measurement value output
- Voltage connected
- Self test running
- Initialization running
- Parameter download running
- Boot process running

PWR



**Green continuous light**

**Power LED green**

- AMS 3007*i* ok
- Measurement value output
- Self test successfully finished
- Device monitoring active

PWR



**Red flashing**

**Power LED flashes red**

- Device ok but warning message (ATT, TMP, LSR) set in display
- Light beam interruption
- Plausibility error (PLB)

PWR



**Red continuous light**

**Power LED red**

- No measurement value output; for details, see Display

PWR



**Orange continuous light**

**Power LED orange**

- Parameter enable active
- No data on the host interface

#### **BUS LED**

BUS



**Off**

**BUS LED off**

- No supply voltage (Power)
- SSI interface deactivated

BUS



**Green continuous light**

**BUS LED green**

- SSI interface is activated

BUS



**Flashing green**

**BUS LED flashes green**

- SSI interface is being initialized

### 8.2.3 Control buttons



**Up**

Navigate upward/laterally.



**Down**

Navigate downward/laterally.



**ESC**



Exit menu item.





**ENTER**

Confirm/enter value, change menu levels.

#### ***Navigating within the menus***

The menus within a level are selected with the up/down buttons  .

The selected menu item is activated with the enter button .

Press the ESC button  to move up one menu level.

When one of the buttons is actuated, the display illumination is activated for 10min.

#### ***Setting values***

If input of a value is possible, the display looks like this:

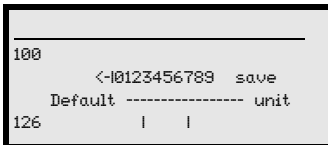





Delete character





Enter digit



Save

Use the   and  buttons to set the desired value. An accidental, incorrect entry can be corrected by selecting <-| and then pressing .

Then use the   buttons to select *save* and save the set value by pressing .

**Selecting options**

If options can be selected, the display looks like this:

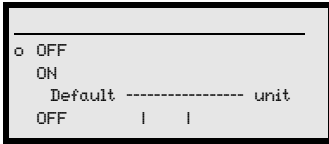

Select the desired option with the buttons. Activate the option by pressing .

**8.3 Menu description**

**8.3.1 The main menus**

After voltage has been applied to the laser, device information is displayed for several seconds. The display then shows the measurement window with all status information.

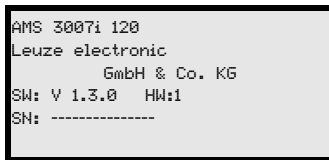

**Device information - main menu**

This menu item contains detailed information on

- Device model,
- Manufacturer,
- Software and hardware version,
- Serial number.

No entries can be made via the display.

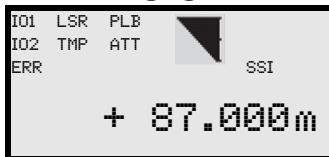

**Status and measurement data - main menu**

- Display of status-, warning-, and error messages.
- Status overview of the switching inputs/outputs.
- Bar graph for the reception level.
- Measurement value.

No entries can be made via this mask.

See "Indicators in the display" on page 39.

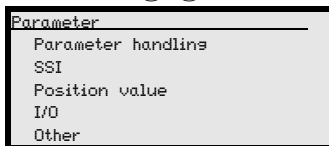

**Parameter - main menu**

- Configuration of the AMS.

See "Parameter menu" on page 44.



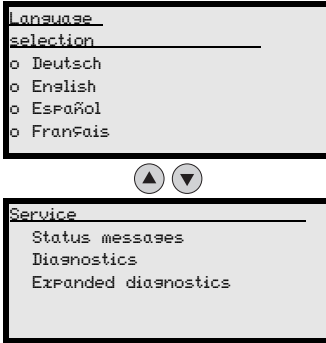

Language selection - main menu

- Selection of the display language. See "Language selection menu" on page 48.

Service - main menu

- Display of status messages.
  - Display of diagnostic data.
- No entries can be made via the display. See "Service menu" on page 48.



**Notice!**

**The rear cover of this manual includes a fold-out page with the complete menu structure. It describes the menu items in brief.**

**8.3.2 Parameter menu**

**Parameter handling submenu**

The following functions can be called up in the Parameter handling submenu:

- Lock and enable parameter entry
- Set up a password
- Reset the AMS 3007i to default settings.

Table 8.1: Parameter handling submenu

Level 3	Level 4	Level 5	Selection/configuration option Description	Standard
Parameter enabling			ON / OFF The standard setting (OFF) prevents unintended parameter changes. With parameter enabling activated (ON), the display is inverted. In this state, it is possible to change parameters manually.	OFF
Password	Activate password		ON / OFF To enter a password, parameter enabling must be activated. If a password is assigned, changes to the AMS 3007i can only be made after the password is entered. The master password 2301 bridges the individually set password.	OFF
	Password entry		Configuration option of a four-digit numerical password	
Parameters to default			By pressing the enter button (↵) after selecting Parameters to default, all parameters are reset to their standard settings without any further security prompts. In this case, English is selected as the display language.	

Additional important information on parameter handling can be found at the end of the chapter.

**SSI submenu**

Table 8.2: SSI submenu

Level 3	Level 4	Level 5	Selection/configuration option Description	Standard
Activation			ON / OFF Activates or deactivates the AMS 3007i as an SSI participant.	ON
Coding			Binary/gray Specifies the output format of the measurement value.	Gray
Number of data bits			24-bit/25-bit/26-bit The measurement value can be displayed on the SSI interface in this data width.	24 bit
SSI resolution			0.001 mm / 0.01 mm / 0.1 mm / 1 mm / 10 mm / free resolution The measurement value can be displayed in these resolutions.	0.1 mm
Error bit			ON/OFF This parameter determines whether an error bit is also attached to the "number of data bits". The error bit is the LSB and is not converted in the case of gray representation of the measurement value.	ON
Error bit function			The error bit can be set with the following status messages: Overflow / intensity (ATT) / temperature (TMP) /laser (LSR) / plausibility (PLB) / hardware (ERR) In the case of multiple namings, the individual states in the error bit are processed in an OR function.	Plausibility (PLB) Hardware (ERR)
Update rate			1.7 / 0.2ms	1,7
Clock frequency			50 - 79kHz / 80 - 800kHz Selection of the clock frequency.	80 - 800kHz

**Position value submenu**

Table 8.3: Position value submenu

Level 3	Level 4	Level 5	Selection/configuration option Description	Standard
Measurement unit			Metric/Inch Specifies the units of the measured distances	Metric
Count direction			Positive/Negative Positive: The measurement value begins at 0 and increases with increasing distance. Negative: The measurement value begins at 0 and decreases with increasing distance. Negative distance values may need to be compensated with an offset or preset.	Positive
Offset			Output value=measurement value+offset The resolution of the offset value is independent of the selected "Resolution position" and is entered in mm or inch/100. The offset value is effective immediately following entry. If the preset value is activated, this has priority over the offset. Preset and offset are not offset against each other.	0mm
Preset			The preset value is accepted by means of teach pulse. The teach pulse can be applied to a hardware input of the M12 PWR connector. The hardware input must be appropriately configured. See also configuration of the I/Os.	0mm



Table 8.3: Position value submenu

Level 3	Level 4	Level 5	Selection/configuration option Description	Standard
Error delay			ON / OFF Specifies whether, in the event of an error, the position value immediately outputs the value of the "Position value in the case of error" parameter or the last valid position value for the configured error delay time.	ON/100 ms
Position value in the case of error			Last valid value / zero Specifies which position value is output after the error delay time elapses.	Zero

### I/O submenu

Table 8.4: I/O submenu

Level 3	Level 4	Level 5	Selection/configuration option Description	Standard
I/O 1	Port configuration		Input/Output Defines whether I/O 1 functions as an output or input.	Output
	Switching input	Function	No function/preset teach/laser ON/OFF	No function
		Activation	Low active/High active	Low active
	Switching output	Function	Pos. limit value 1 / Pos. limit value 2 / Velocity / Intensity (ATT) / Temp. (TMP) / Laser (LSR) / Plausibility (PLB) / Hardware (ERR) The individual functions are "ORed" on the selected switching output.	Plausibility (PLB), hardware (ERR)
Activation		Low active/High active	Low active	
I/O 2	Port configuration		Input/Output Defines whether I/O 2 functions as an output or input.	Output
	Switching input	Function	No function/preset teach/laser ON/OFF	No function
		Activation	Low active/High active	Low active
	Switching output	Function	Pos. limit value 1 / Pos. limit value 2 / Velocity / Intensity (ATT) / Temp. (TMP) / Laser (LSR) / Plausibility (PLB) / Hardware (ERR) The individual functions are "ORed" on the selected switching output.	Intensity (ATT), Temp. (TMP), Laser (LSR)
Activation		Low active/High active	Low active	
Limit values	Upper pos. limit 1	Activation	ON / OFF	OFF
		Limit value input	Value input in mm or inch/100	0
	Lower pos. limit 1	Activation	ON / OFF	OFF
		Limit value input	Value input in mm or inch/100	0
	Upper pos. limit 2	Activation	ON / OFF	OFF
		Limit value input	Value input in mm or inch/100	0
Lower pos. limit 2	Activation	ON / OFF	OFF	

Table 8.4: I/O submenu

Level 3	Level 4	Level 5	Selection/configuration option Description	Standard
		Limit value input	Value input in mm or inch/100	0
	Max. speed	Activation	ON / OFF	OFF
		Max. speed	Value input in mm/s or inch/100s	0

**Other submenu**

Table 8.5: Other submenu

Level 3	Level 4	Level 5	Selection/configuration option Description	Standard
Display illumination			10 minutes/ON Display illumination is switched off after 10 minutes or, if the parameter is set to "ON", illumination is always on.	10 min.
Display contrast			Weak/Medium/Strong The display contrast may change at extreme temperature values. The contrast can subsequently be adapted using the three levels.	Medium
Service RS232	Baud rate		57.6kbit/s / 115.2kbit/s The service interface is only available to Leuze internally.	115.2kbit/s
	Format		8,e,1 / 8,n,1 The service interface is only available to Leuze internally.	8,n,1

### 8.3.3 Language selection menu

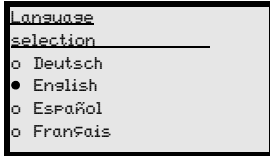

5 display languages are available:

- German
- English
- Spanish
- French
- Italian

The AMS 3007*i* is delivered from the factory with the display preset to English.

To change the language, no password needs to be entered nor must password enabling be activated. The display language is a passive operational control and is, thus, not a function parameter, per se.

### 8.3.4 Service menu

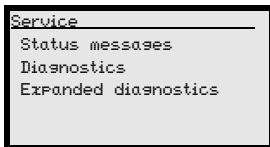

A more detailed description of the individual functions can be found in chapter 10.

## 8.4 Operation

Described here is an operating process using parameter enabling as an example.

### Parameter enabling

During normal operation parameters can only be viewed. If parameters are to be changed, the ON menu item in the Parameter → Parameter handling → Parameter enable menu must be activated. To do this, proceed as follows:

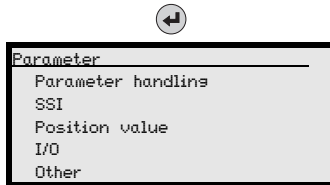

In the main menu, press the enter button to enter the Parameter menu.

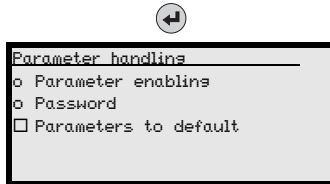

Use the ▲▼ buttons to select the Parameter handling menu item.

Press the enter button to enter the Parameter handling menu.

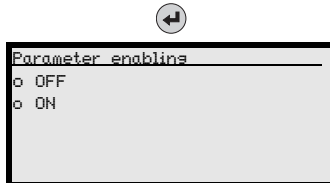

In the Parameter handling menu, use the ▲▼ buttons to select the Parameter enablns menu item.

Press the enter button to enter the Parameter enablns menu.



In the Parameter enabling menu, use the ▲▼ buttons to select the ON menu item.

Press the enter button to switch on parameter enabling.

The PWR LED illuminates orange; the display is inverted. You can now set the individual parameters on the display.

Press the ESC button twice to return to the Parameter menu.



### Viewing and editing parameters

As long as parameter enabling is activated, the entire AMS 3007i display is inverted.



### Notice!

If a password was stored, parameter enabling is not possible until this password is entered, see "Password for parameter enabling" below.

For the SSI interface, the communication between the control and the AMS 3007i is also active the case of parameter enabling.



**Notice!**

Changes to the SSI parameters via display entry have immediate effect.



**Password for parameter enabling**

Parameter entry on the AMS 3007i can be protected with a password.

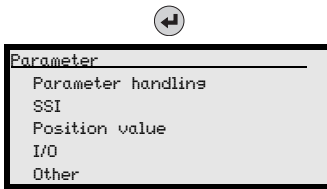
If a password is assigned, parameter enabling must be activated via the password. If parameter enabling has been activated after successfully entering the password, parameters can be changed via the display.



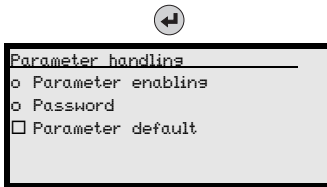

In the main menu, press the enter button to enter the Parameter menu.

Use the   buttons to select the Parameter handling menu item.



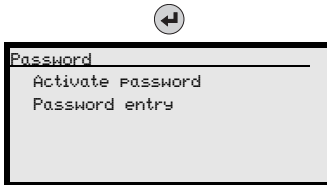

Press the enter button to enter the Parameter handling menu.

In the Parameter handling menu, use the   buttons to select the Password menu item.





Press the enter button to enter the Password menu.

In the Password menu, use the   buttons to select the Activate password menu item.





Press the enter button to enter the Password menu.

In the Activate password menu, use the   buttons to select the ON menu item and press the enter button



Press the ESC button to return to the Password menu.



In the Password menu, use the   buttons to select the Password entry menu item.

Press the enter button to enter the Password menu.

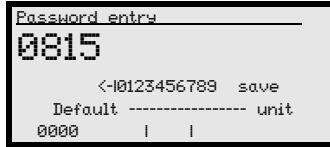

Now enter the password (digits). See "Setting values" on page 42.

Press the ESC button twice to return to the Parameter menu.



**Notice!**

The **master password 2301** can enable the AMS 3007i at any time.

## 9 SSI interface

### 9.1 Principle functionality of the SSI interface

Data communication of the SSI interface is based on differential transmission as is used for RS 422 interfaces. Transmission of the position value, beginning with the MSB (most significant bit), is thus synchronised with a clock cycle (CLOCK) specified by the control.

In the quiescent state, both the clock line as well as the data line are at HIGH level. At the first HIGH-LOW edge (point ① in figure 9.1) the data in the internal register are stored. This ensures that the data are not changed during serial transfer of the value.

When the next clock signal change from LOW to HIGH level (point ② in figure 9.1) occurs transmission of the position value begins with the most significant bit (MSB). With each subsequent change of the clock signal from LOW to HIGH level, the next least-significant bit is transmitted on the data line. After the least significant bit (LSB) has been output, the clock signal switches from LOW to HIGH for one last time and the data line switches to LOW level (end of transmission).

A monoflop retriggered by the clock signal determines the time span before the SSI interface can be called for the next transmission. This results in the minimum pause time between two successive clock cycles. If time  $t_m = 20\mu\text{s}$  has elapsed, the data line is returned to the quiescent level (HIGH) (point ③ in figure 9.1). This signals completed data communication and that the device is again ready for transmission.



#### **Notice!**

*If the off-cycle of data transmission is interrupted for longer than  $t_m = 20\mu\text{s}$ , the next cycle will begin with a completely new transmission cycle with a newly calculated value.*

*If a new transmission cycle is started before time  $t_m$  has elapsed, the previous value is output again.*



#### **Attention!**

***The SSI interface can only represent positive distance values. If negative output values are ascertained due to the offset or count direction, a zero value is output at the SSI interface! In the event of a number overflow, all data bits are set to "1".***

9.1.1 SSI sequence diagram

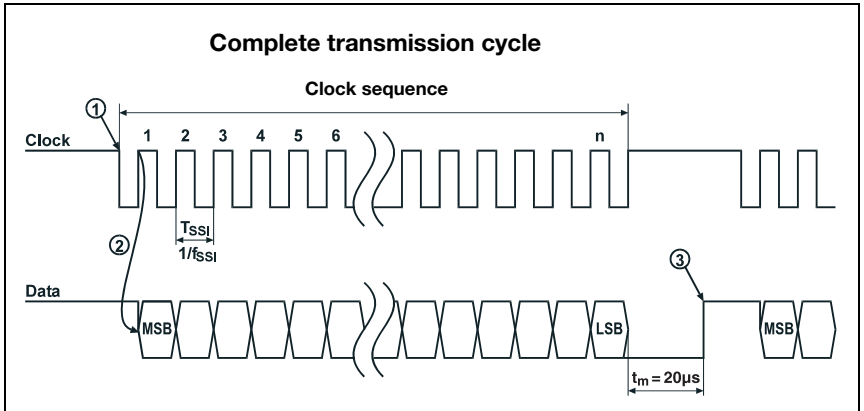

Figure 9.1: SSI data transmission sequence diagram



**Notice!**

In the default setting the **LSB** bit is the error bit.



**Attention!**

**Significance of the error bit:**

By default a 25th error bit (LSB) is appended to the 24-bit measurement value. The error bit is not included in the Gray encoding of the measurement value. The error bit is 1 = active, 0 = not active.



**Notice!**

The data can be read out with a clock rate between 80kHz and 800kHz.



**Attention!**

**Updating the measurement values on the SSI interface of the AMS 3007i:**

The measurement value on the SSI interface of the AMS 3007i is updated every 1.7ms (default) independent of the clock frequency. The update rate on the interface can be reduced to 0.2ms via the display under the SSI menu item.



**9.1.2 Cable length as a function of the data rate**

Only shielded and twisted pair lines (pin 1 with 2 and pin 3 with 4) are permitted as data lines for the SSI interface (see chapter 9.2 "SSI - electrical connection").

↳ The shielding must be connected at both ends.

↳ Do not lay the cable parallel to power cables.

The maximum possible cable length is dependent on the cable used and the clock rate:

Data rate	80kBit/s	100kBit/s	200kBit/s	300kBit/s	400kBit/s	500kBit/s	1,000kBit/s
Max. cable length (typical)	500m	400m	200m	100m	50m	25m	10m

Table 9.1: Max. cable length as a function of the clock rate

**9.2 SSI - electrical connection**

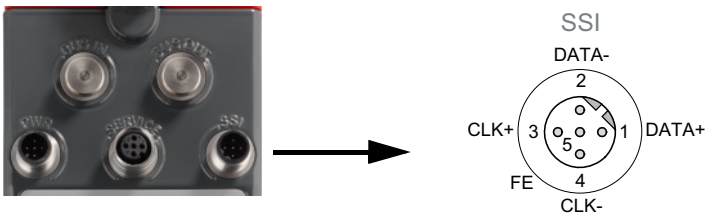

SSI connector (5-pin plug, B-coded)		
Pin	Name	Remark
1	DATA+	+ Data line SSI (output)
2	DATA-	- Data line SSI (output)
3	CLK+	+ Clock line SSI (input electrically insulated)
4	CLK-	- Clock line SSI (input electrically insulated)
5	FE	Functional earth
Thread	FE	Functional earth (housing)

Figure 9.2: SSI - electrical connection



**Notice!**

To connect the SSI interface we recommend our ready-made SSI cables, see chapter 11.4.5.

### 9.3 Default settings of the SSI interface

Default parameters of the SSI interface	
SSI activation	ON
Measurement value coding	Gray
Transmission mode	24-bit measurement value + 1-bit error (error: 1 = active), error bit = LSB
Resolution	0.1 mm
Default error bit	Plausibility error or hardware error
Update rate	1.7 ms
Measurement unit	Metric
Count direction	Positive (the SSI interface cannot represent negative values)
I/O 1	Output – plausibility error or hardware error
I/O 2	Output – temperature error, intensity error or laser prefailure message
Static preset	+000.000
Dynamic preset	+000.000
Position limit value range 1	Lower limit and upper limit: both 0
Position limit value range 2	Lower limit and upper limit: both 0
Error handling procedures	Position output: 0
	Suppress position status: active
	Position suppression time: 100 ms
Display language	English
Display illumination	OFF after 10 min.
Display contrast	Medium
Password protection	Off
Password	0000

Table 9.2: Default settings of the SSI interface

#### 9.3.1 Changing the SSI settings via the display



**Notice!**

*For basic operation of the display please refer to chapter 8.2.3.*

*In order to change the parameters please activate parameter enabling.*

*The SSI interface remains active even during parameter enabling. Changes to parameters have an immediate effect.*



## 10 Diagnostics and troubleshooting

### 10.1 Service and diagnostics in the display of the AMS 3007*i*

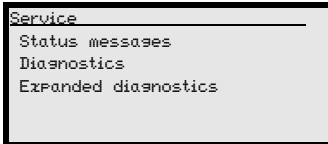
In the main menu of the AMS 3007*i*, expanded "Diagnostics" can be called up under the Service heading.



From the Service main menu, press the enter button  to access the underlying menu level.

Use the up/down buttons   to select the corresponding menu item in the selected level; use the enter button  to activate the selection.

Return from any sub-level to the next-higher menu item by pressing the ESC button .

#### 10.1.1 Status messages

The status messages are written in a ring memory with 25 positions. The ring memory is organized according to the FIFO principle. No separate activation is necessary for storing the status messages. Power OFF clears the ring memory.

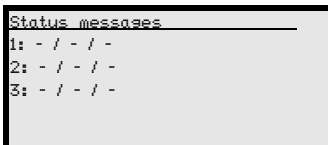

#### *Basic representation of the status messages*

**n:** Type / No. / 1

Meaning:



**n:** memory position in the ring memory

**Type:** type of message:

**I** = info, **W** = warning, **E** = error, **F** = severe system error.

**No:** internal error detection

**1:** frequency of the event (always "1", since no summation occurs)

The status messages within the ring memory are selected with the up/down buttons  . The enter button  can be used to call up **detailed information** on the corresponding status messages with the following details:

**Detailed information about a status message**

- Type:** type of message + internal counter
- UID:** Leuze internal coding of the message
- ID:** description of the message
- Info:** not currently used

Within the detailed information, the enter button  can be pressed again to activate an **action menu** with the following functions:



- Acknowledge message
- Delete message
- Acknowledge all
- Delete all

**10.1.2 Diagnostics**

The diagnostics function is activated by selecting the `Diagnostics` menu item. The ESC button  deactivates the diagnostics function and clears the contents of the recordings.

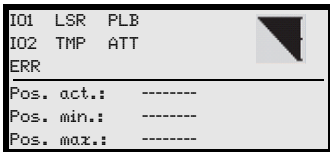
The recorded diagnostic data are displayed in 2 fields. In the upper half of the display, status messages of the AMS 3007*i* and the bar graph are displayed. The lower half contains information that assists in a Leuze-internal evaluation.



Use the up/down buttons   to scroll in the bottom half between various displays. The contents of the scrollable pages are intended solely for Leuze for internal evaluation.

The diagnostics have no influence on the communication to the host interface and can be activated during operation of the AMS 3007*i*.

**10.1.3 Expanded diagnostics**

The `Expanded diagnostics` menu item is used for Leuze-internal evaluation.

## 10.2 General causes of errors

### 10.2.1 Power LED

See also chapter 8.2.2.

Error	Possible error cause	Measure
PWR LED "OFF"	No supply voltage connected	Check supply voltage.
	Hardware error	Send in device.
PWR-LED "flashes red"	Light beam interruption	Check alignment.
	Plausibility error	Traverse rate >10m/s.
PWR-LED "static red"	Hardware error	For error description, see display, It may be necessary to send in the device.

Table 10.1: General causes of errors

## 10.3 Interface errors

### 10.3.1 BUS LED

Error	Possible error cause	Measure
BUS LED "OFF"	No supply voltage connected	Check supply voltage.
	Incorrect wiring	Check wiring.
	SSI deactivated	Activate SSI interface in the AMS 3007 <i>i</i> .

Table 10.2: Bus error

**10.4 Status display in the display of the AMS 3007*i***

Display	Possible error cause	Measure
<b>PLB</b> (implausible measurement values)	Laser beam interruption	Laser spot must always be incident on the reflector.
	Laser spot outside of reflector	Traverse rate < 10m/s?
	Measurement range for maximum distance exceeded	Restrict traversing path or select AMS with larger measurement range.
	Velocity greater than 10 m/s	Reduce velocity.
<b>ATT</b> (insufficient received signal level)	Ambient temperature far outside of the permissible range (TMP display; PLB)	Provide cooling.
	Reflector soiled	Clean reflector or glass lens.
	Glass lens of the AMS soiled	
	Performance reduction due to snow, rain, fog, condensing vapor, or heavily polluted air (oil mist, dust)	Optimize usage conditions.
Laser spot only partially on the reflector	Check alignment.	
<b>TMP</b> (operating temperature outside of specification)	Protective foil on the reflector	Remove protective foil from reflector.
	Ambient temperatures outside of the specified range	In case of low temperatures, remedy may be an AMS with heating. If temperatures are too high, provide cooling or change mounting location.
<b>LSR</b> Laser diode warning	Laser diode prefailure message	Send in device at next possible opportunity to have laser diode replaced. Have replacement device ready.
<b>ERR</b> Hardware error	Indicates an uncorrectable error in the hardware	Send in device for repair.



**Notice!**

Please use **chapter 10 as a master copy** should servicing be required. Cross the items in the "Measures" column which you have already examined, fill out the following address field and fax the pages together with your service contract to the fax number listed below.

**Customer data (please complete)**

<b>Device type:</b>	
<b>Company:</b>	
<b>Contact person / department:</b>	
<b>Phone (direct dial):</b>	
<b>Fax:</b>	
<b>Street / No:</b>	
<b>ZIP code/City:</b>	
<b>Country:</b>	

**Leuze Service fax number:**

**+49 7021 573 - 199**

## 11 Type overview and accessories

### 11.1 Part number code

AMS	30	xx	i	yyy
		Range	40	Max. operating range in m
			120	Max. operating range in m
			200	Max. operating range in m
			i =	Integrated fieldbus technology
		Interface	04	PROFIBUS DP interface
			07	SSI interface
			AMS	Absolute Measuring System

### 11.2 Type overview AMS 3007*i* (SSI)

Type designation	Description	Part no.
AMS 3007 <i>i</i> 40	40 m operating range, SSI interface	50130196
AMS 3007 <i>i</i> 120	120m operating range, SSI interface	50130197
AMS 3007 <i>i</i> 200	200m operating range, SSI interface	50130198

Table 11.1: Type overview AMS 3007*i*

### 11.3 Overview of reflector types

Type designation	Description	Part no.
Reflective tape 200x200-S	Reflective tape, 200x200mm, self-adhesive	50104361
Reflective tape 500x500-S	Reflective tape, 500x500mm, self-adhesive	50104362
Reflective tape 914x914-S	Reflective tape, 914x914mm, self-adhesive	50108988
Reflective tape 200x200-M	Reflective tape, 200x200mm, affixed to aluminum plate	50104364
Reflective tape 500x500-M	Reflective tape, 500x500mm, affixed to aluminum plate	50104365
Reflective tape 914x914-M	Reflective tape, 914x914mm, affixed to aluminum plate	50104366
Reflective tape 200x200-H	Heated reflective tape, 200 x 200mm	50115020
Reflective tape 500x500-H	Heated reflective tape, 500 x 500mm	50115021
Reflective tape 914x914-H	Heated reflective tape, 914 x 914mm	50115022

Table 11.2: Overview of reflector types

## 11.4 Accessories

### 11.4.1 Accessory mounting bracket

Type designation	Description	Part no.
MW OMS/AMS 01	Mounting bracket for mounting the AMS 3007 <i>i</i> to horizontal surfaces	50107255

Table 11.3: Accessory mounting bracket

### 11.4.2 Accessory deflector unit

Type designation	Description	Part no.
US AMS 01	Deflector unit with integrated mounting bracket for the AMS 3007 <i>i</i> . Variable 90° deflection of the laser beam in various directions	50104479
US 1 OMS	Deflector unit without mounting bracket for simple 90° deflection of the laser beam	50035630

Table 11.4: Accessory deflector unit

### 11.4.3 Accessory M12 connector

Type designation	Description	Part no.
KD 02-5-BA	M12 connector, B-coded socket, SSI	50038538
KD 095-5A	M12 connector, A-coded socket, Power (PWR)	50020501

Table 11.5: Accessory M12 connector



### 11.4.4 Accessory ready-made cables for voltage supply

#### Contact assignment/wire color of PWR connection cable

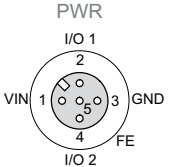
PWR connection cable (5-pin socket, A-coded)			
 <p>M12 socket (A-coded)</p>	Pin	Name	Core color
	1	VIN	brown
	2	I/O 1	white
	3	GND	blue
	4	I/O 2	black
	5	FE	gray
	Thread	FE	bare

#### Specifications of the cables for voltage supply

**Operating temperature range**      in rest state: -30°C ... +70°C  
in motion: -5°C ... +70°C

**Material**      sheathing: PVC

**Bending radius**      > 50mm

#### Order codes of the cables for voltage supply

Type designation	Description	Part no.
K-D M12A-5P-5m-PVC	M12 socket, A-coded, axial plug outlet, open cable end, cable length 5m	50104557
K-D M12A-5P-10m-PVC	M12 socket, A-coded, axial plug outlet, open cable end, cable length 10m	50104559

**11.4.5 Accessory ready-made cables for the SSI interface**

**General**

- **KB SSI...** cable for connecting to the SSI M12 connector
- Standard cables available in lengths from 2 ... 30m
- Special cables on request.

**Contact assignments of SSI connection cable**

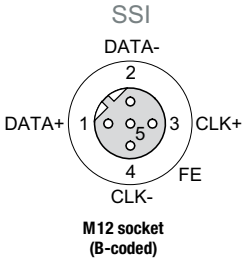
SSI/IBS connection cable (5-pin socket, B-coded)			
	Pin	Name	Core color
 <p>SSI DATA- 2 DATA+ 1 3 CLK+ 4 FE CLK- M12 socket (B-coded)</p>	1	DATA+	<b>yellow</b>
	2	DATA-	<b>Green</b>
	3	CLK+	<b>gray</b>
	4	CLK-	<b>pink</b>
	5	FE	<b>brown</b>
	Thread	FE	<b>bare</b>

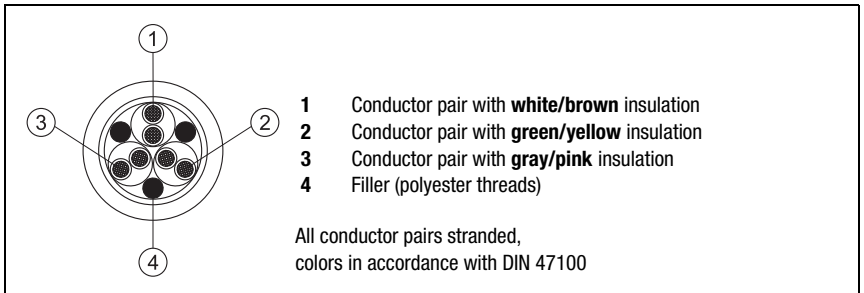

**Specifications of the SSI connection cable**

- Operating temperature range** in rest state: -40°C ... +80°C  
 in motion: -5°C ... +80°C
- Material** free of halogens, silicone and PVC
- Bending radius** > 80mm, suitable for drag chains

**Order codes for SSI connection cables**

Type designation	Remark	Part no.
KB SSI/IBS-2000-BA	M12 socket, B-coded, for SSI/Interbus, axial connector, open cable end, cable length 2m	50104172
KB SSI/IBS-5000-BA	M12 socket, B-coded, for SSI/Interbus, axial connector, open cable end, cable length 5m	50104171
KB SSI/IBS-10000-BA	M12 socket, B-coded, for SSI/Interbus, axial connector, open cable end, cable length 10m	50104170
KB SSI/IBS-15000-BA	M12 socket, B-coded, for SSI/Interbus, axial connector, open cable end, cable length 15m	50104169
KB SSI/IBS-20000-BA	M12 socket, B-coded, for SSI/Interbus, axial connector, open cable end, cable length 20m	50104168
KB SSI/IBS-25000-BA	M12 socket, B-coded, for SSI/Interbus, axial connector, open cable end, cable length 25m	50108447
KB SSI/IBS-30000-BA	M12 socket, B-coded, for SSI/Interbus, axial connector, open cable end, cable length 30m	50108446

## 12 Maintenance

### 12.1 General maintenance information

With normal use, the laser measurement system does not require any maintenance by the operator.

#### **Cleaning**

In the event of dust build-up or if the (ATT) warning message is displayed, clean the device with a soft cloth; use a cleaning agent (commercially available glass cleaner) if necessary. Also check the reflector for possible soiling.



#### **Attention!**

*Do not use solvents and cleaning agents containing acetone. Use of such solvents could blur the reflector, the housing window and the display.*

### 12.2 Repairs, servicing



#### **Attention!**

*Access to or changes on the device, except where expressly described in this operating manual, are not authorized. The device must not be opened. Failure to comply will render the guarantee void. Warranted features cannot be guaranteed after the device has been opened.*

Repairs to the device must only be carried out by the manufacturer.

*Contact your Leuze distributor or service organization should repairs be required. The addresses can be found on the inside of the cover and on the back.*



#### **Notice!**

*When sending the laser measurement systems to Leuze electronic for repair, please provide an accurate description of the error.*

### 12.3 Disassembling, packing, disposing

#### **Repacking**

For later reuse, the device is to be packed so that it is protected.

#### **Notice!**

*Electrical scrap is a special waste product! Observe the locally applicable regulations regarding disposal of the product.*

<b>A</b>		<b>H</b>	
Accessories	60	Heated reflectors	
Accessory deflector unit	61	Dimensioned drawing	30
Accessory mounting bracket	61	Technical data	29
Accessory ready-made cables	62		
Accuracy	13	<b>I</b>	
Air humidity	14	Installation	17
Alignment	19	Interface errors	58
		Interface info in display	40
		Internal hardware error	40
<b>B</b>			
BUS LED	41	<b>L</b>	
		LSR status display	59
<b>C</b>			
Cleaning	65	<b>M</b>	
Connections		Main menu	
PWR IN	37	Device information	43
Service	38	Language selection	44
SSI	37	Parameter	43
Control buttons	42	Service	44
Control panel	39	Maintenance	65
		Measurement range	13
		Measurement value output	13
<b>D</b>		Menus	
Declaration of conformity	4	Language selection menu	48
Deflector unit		Main menu	43
Maximum ranges	23	Parameter menu	44
With integrated mounting bracket	23	Service menu	48
Without mounting bracket	25	Mounting	18
Deflector unit US 1 OMS		with laser beam deflector unit	23
Dimensioned drawing	25	Mounting bracket(optional)	20
Deflector unit US AMS 01			
Dimensioned drawing	24	<b>N</b>	
Description of functions	5	Name plates	17
Diagnostics	56		
Dimensioned drawing of AMS 3xxi	15	<b>O</b>	
Display	39	Operating principle	11
		Operating temperature	14
		Operation	39, 49
		Overview of reflector types	60
<b>E</b>			
Electrical connection	36	<b>P</b>	
Safety notices	36	Packaging	17
Expanded diagnostics	57	Parallel mounting	21
Explanation of symbols	4	Parameter enabling	49, 50
		Parameter menu	
		I/O	46
<b>F</b>			
Fast commissioning	11		
<b>G</b>			
General causes of errors	58		

Other .....	47	Dimensioned drawing .....	15
Parameter handling .....	44	General specifications .....	13
Position value .....	45	Reflective tapes .....	26
SSI .....	45	Temperature monitoring .....	39
Plausibility error .....	40	Transport .....	17
Prefailure message .....	39	Troubleshooting .....	56
PWR LED .....	41	Type overview .....	16, 60

**Q**

Quality assurance .....	4
-------------------------	---

**R**

Range .....	60
Received signal .....	40
Reflective tape	
Dimensioned drawing .....	28
Technical data .....	27
Reflector .....	26
Mounting .....	32
Pitch .....	35
Size .....	31
Type overview .....	31
Repair .....	65

**S**

Servicing .....	65
SSI .....	52
Default settings .....	55
Electrical connection .....	54
Status and measurement data - main menu	43
Status- and warning messages .....	39
Status display .....	39
ATT .....	59
ERR .....	59
PLB .....	59
TMP .....	59
Status display in the display .....	59
Status displays .....	41
Status messages .....	56
Storage .....	17
Storage temperature .....	14
Supply voltage .....	13
Surface reflections .....	33
Symbols .....	4

**T**

Technical data .....	13
----------------------	----

Level 1	Level 2	Level 3	Level 4	Level 5	Selection/configuration option	Detailed information on
▲▼ : selection	▲▼ : selection ESC : back	▲▼ : selection ESC : back	▲▼ : selection ESC : back	▲▼ : selection ESC : back	▲▼ : selection ↵ : activate ESC : back	
Device information						page 43
Network information						page 43
Status- and measurement data						page 43
Parameter	↵ Parameter handling	↵ Parameter enabling			ON / OFF	page 44
		↵ Password	↵ Activate password		ON / OFF	
			↵ Password entry		Configuration option of a four-digit numerical password	
	↵ Parameters to default				All parameters are reset to their factory settings	
↵ SSI	↵ SSI	↵ Activation			ON / OFF	page 45
		↵ Coding			Binary/gray	
		↵ Number of data bits			24-bit/25-bit/26-bit	
		↵ SSI resolution			0.001 mm / 0.01 mm / 0.1 mm / 1 mm / 10 mm / free resolution	
		↵ Error bit			ON / OFF	
		↵ Error bit function			overflow, intensity (ATT) temp. (TMP) laser (LSR) plausibility (PLB) hardware (ERR)	
		↵ Update rate			1.7 ms / 0.2 ms	
		↵ Clock frequency			80kHz - 800kHz, 20us / 50kHz - 79kHz, monoflop time 30us	
↵ Position value	↵ Position value	↵ Measurement unit			Metric/Inch	page 45
		↵ Count direction			Positive/Negative	
		↵ Offset			Value input:	
		↵ Preset			Value input	
		↵ Error delay			ON / OFF	
		↵ Position value in the case of error			Last valid value / zero	
		↵ I/O	↵ I/O 1	↵ Port configuration		
↵ Switching input	↵ Function					No function/preset teach/laser ON/OFF
	↵ Activation				Low active/High active	
↵ Switching output	↵ Function				Pos. limit value 1 / Pos. limit value 2 / Velocity / Intensity (ATT) / Temp. (TMP) / Laser (LSR) / Plausibility (PLB) / Hardware (ERR)	
	↵ Activation				Low active/High active	
↵ I/O 2	↵ Port configuration					Input/Output
			↵ Switching input	↵ Function		No function/preset teach/laser ON/OFF
			↵ Activation		Low active/High active	
↵ Switching output	↵ Function			Pos. limit value 1 / Pos. limit value 2 / Velocity / Intensity (ATT) / Temp. (TMP) / Laser (LSR) / Plausibility (PLB) / Hardware (ERR)		
	↵ Activation		Low active/High active			

	<ul style="list-style-type: none"> <li>⊞ Limit values                             <ul style="list-style-type: none"> <li>⊞ Upper pos. limit 1                                     <ul style="list-style-type: none"> <li>⊞ Activation ON / OFF</li> <li>⊞ Limit value input Value input in mm or inch/100</li> </ul> </li> <li>⊞ Lower pos. limit 1                                     <ul style="list-style-type: none"> <li>⊞ Activation ON / OFF</li> <li>⊞ Limit value input Value input in mm or inch/100</li> </ul> </li> <li>⊞ Upper pos. limit 2                                     <ul style="list-style-type: none"> <li>⊞ Activation ON / OFF</li> <li>⊞ Limit value input Value input in mm or inch/100</li> </ul> </li> <li>⊞ Lower pos. limit 2                                     <ul style="list-style-type: none"> <li>⊞ Pos limit value active. ON / OFF</li> <li>⊞ Position value Value input in mm or inch/100</li> </ul> </li> <li>⊞ Max. speed                                     <ul style="list-style-type: none"> <li>⊞ Activation ON / OFF</li> <li>⊞ Max. speed Value input in mm/s or inch/100s</li> </ul> </li> </ul> </li> </ul>			
⊞ Other	<ul style="list-style-type: none"> <li>⊞ Display background 10 minutes/ON</li> <li>⊞ Display contrast Weak/Medium/Strong</li> <li>⊞ Service RS232                             <ul style="list-style-type: none"> <li>⊞ Baud rate 57.6kbit/s / 115.2kbit/s</li> <li>⊞ Format 8,e,1 / 8,n,1</li> </ul> </li> </ul>			page 47
Language selection	⊞		Deutsch / English / Español / Français / Italiano	page 48
Service	⊞ Status messages		Number of readings, reading gates, reading rate / non-reading rate etc.	page 48
	⊞ Diagnostics		Exclusively for service purposes by Leuze electronic	
	⊞ Expanded diagnostics		Exclusively for service purposes by Leuze electronic	