

Technical data sheet

Camera

Part no.: 50141925

LCAM 408i C7F-XX-MT

Contents

- Technical data
- Dimensioned drawings
- Electrical connection
- Accessories



For illustration purposes only



Technical data

Basic data

Series	LCAM
Suitable for	Use of coolants and lubricants
Chip	CMOS

Special version

Special version	Optics can be cleaned via compressed air connection with max. 6 bar
-----------------	---

Functions

Software functions	Image transfer
--------------------	----------------

Optical data

Working range	1,000 ... 5,000 mm
Camera resolution, horizontal	2,592 px
Camera resolution, vertical	1,944 px
Focal length	4 mm
Chip size	1/2.5 in
Frame rate (images per second), max.	53 pieces per second
Camera type	Color

Electrical data

Performance data	
Supply voltage U_B	18 ... 30 V, DC
Power consumption, max.	3.6 W

Interface

Type	Ethernet
Ethernet	
Address assignment	DHCP Manual address assignment
Transmission speed	1 Gbit/s 10 Mbit/s 100 Mbit/s
Function	Process Service
Switch functionality	None
Transmission protocol	TCP/IP, RTP/RTSP

Connection

Connection 1	
Function	Configuration interface Data interface Service interface
Type of connection	Connector
Designation on device	SERVICE
Thread size	M12
No. of pins	8 -pin
Encoding	X-coded

Connection 2

Function	Voltage supply
Type of connection	Connector
Designation on device	PWR
Thread size	M12
No. of pins	4 -pin
Encoding	A-coded

Mechanical data

Dimension (W x H x L)	76.5 mm x 66 mm x 126 mm
Housing material	Metal
Lens cover material	Glass (seal material: FKM)
Net weight	664 g
Type of fastening	Dovetail grooves Mounting thread Via optional mounting device

Environmental data

Ambient temperature, operation	-30 ... 70 °C
--------------------------------	---------------

Certifications

Degree of protection	IP 65 IP 67
----------------------	----------------

Classification

Customs tariff number	90021100
ECLASS 5.1.4	27310101
ECLASS 8.0	27310101
ECLASS 9.0	27310201
ECLASS 10.0	27310101
ECLASS 11.0	27310101
ECLASS 12.0	27310101
ECLASS 13.0	27310101
ECLASS 14.0	27310101
ETIM 5.0	EC002550
ETIM 6.0	EC002550
ETIM 7.0	EC002550
ETIM 8.0	EC002550
ETIM 9.0	EC002550

Dimensioned drawings

All dimensions in millimeters

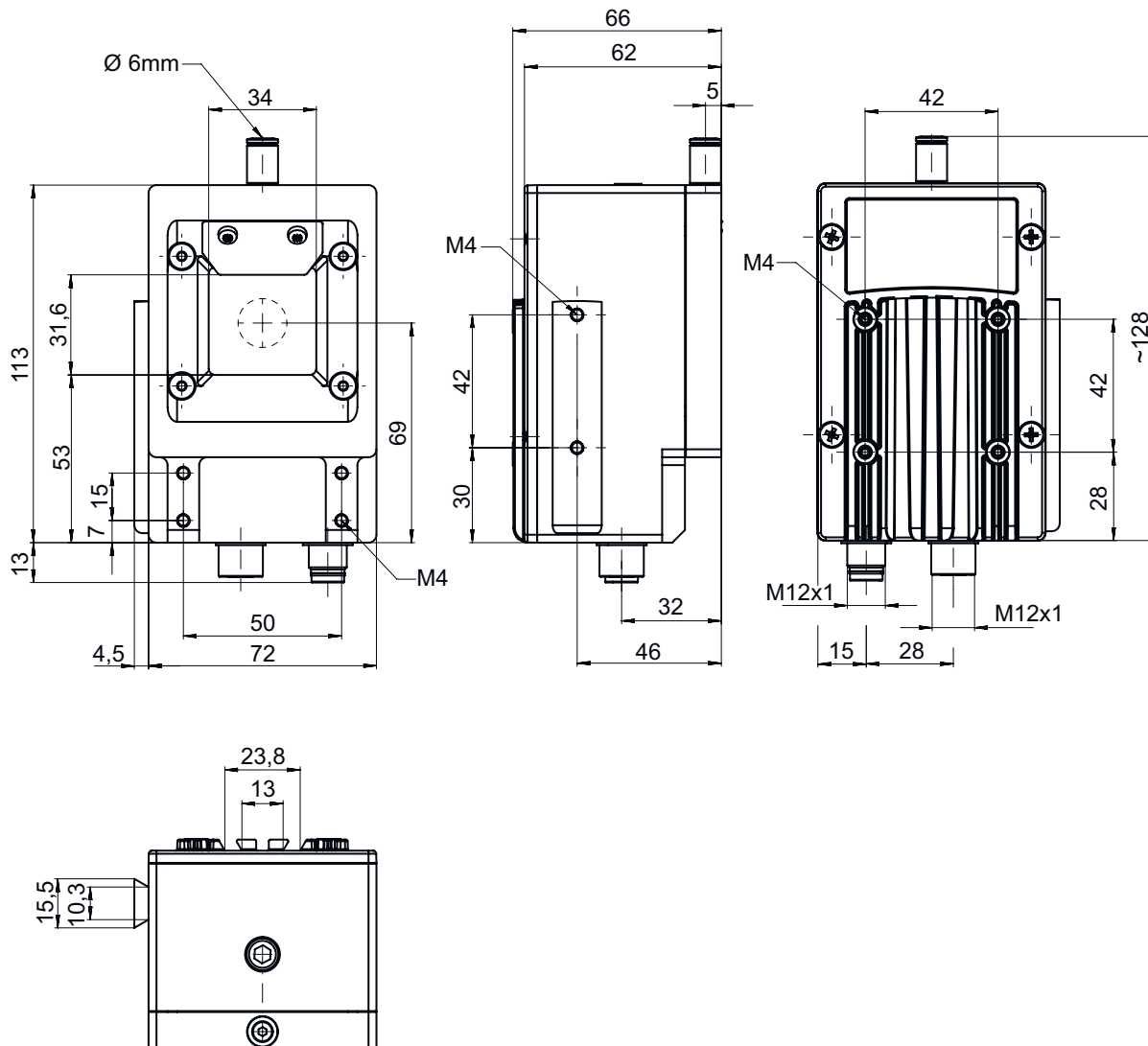

Electrical connection

Connection 1

SERVICE

Function	Configuration interface Data interface Service interface
Type of connection	Connector
Thread size	M12
Type	Female
Material	Metal
No. of pins	8 -pin
Encoding	X-coded

Electrical connection

Pin	Pin assignment
1	D1+
2	D1-
3	D2+
4	D2-
5	D4+
6	D4-
7	D3-
8	D3+

Connection 2	PWR
Function	Voltage supply
Type of connection	Connector
Thread size	M12
Type	Male
Material	Metal
No. of pins	4 -pin
Encoding	A-coded

Pin	Pin assignment
1	V+
2	n.c.
3	GND
4	n.c.

Accessories

Connection technology - Connection cables

	Part no.	Designation	Article	Description
	50130657	KD U-M12-4A-P1-050	Connection cable	Connection 1: Connector, M12, Axial, Female, A-coded, 4 -pin Connector, LED: No Connection 2: Open end Shielded: No Cable length: 5,000 mm Sheathing material: PUR

Connection technology - Interconnection cables

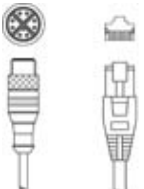
	Part no.	Designation	Article	Description
	50130743	KDS U-M12-4A-M12-4A-P1-050	Interconnection cable	Connection 1: Connector, M12, Axial, Female, A-coded, 4 -pin Connection 2: Connector, M12, Axial, Male, A-coded, 4 -pin Shielded: No Cable length: 5,000 mm Sheathing material: PUR
	50137380	KSS GB-M12-8A-RJ45-A-P7-050	Interconnection cable	Suitable for interface: Ethernet Connection 1: Connector, M12, Axial, Male, X-coded, 8 -pin Connection 2: RJ45 Shielded: Yes Cable length: 2,000 mm Sheathing material: PUR

Accessories

Connection technology - Connectors

	Part no.	Designation	Article	Description
	50137169	S GB-RJ45-8A-K-SK	Connector	Suitable for interface: Ethernet Connection: RJ45

Mounting technology - Mounting brackets

	Part no.	Designation	Article	Description
	50121433	BT 300 W	Mounting device	Design of mounting device: Angle, L-shape Fastening, at system: Through-hole mounting Mounting bracket, at device: Screw type Type of mounting device: Adjustable Material: Metal

Mounting technology - Rod mounts

	Part no.	Designation	Article	Description
	50027375	BT 56	Mounting device	Functions: Static applications Design of mounting device: Mounting system Fastening, at system: For 16 mm rod, For 18 mm rod, For 20 mm rod Mounting bracket, at device: Clampable Material: Metal Tightening torque of the clamping jaws: 8 N·m

Note



A list with all available accessories can be found on the Leuze website in the Download tab of the article detailed page.