

## Technical data sheet

### Throughbeam photoelectric sensor receiver

Part no.: 50154156

LE28/PX-M12



For illustration purposes only

#### Contents

- Technical data
- Dimensioned drawings
- Electrical connection
- Diagrams
- Operation and display
- Suitable transmitters
- Part number code
- Notes
- Further information
- Accessories



## Technical data

### Basic data

|                     |                       |
|---------------------|-----------------------|
| Series              | 28                    |
| Operating principle | Throughbeam principle |
| Device type         | Receiver              |

### Optical data

|                 |                 |
|-----------------|-----------------|
| Operating range | see transmitter |
|-----------------|-----------------|

### Electrical data

|                    |   |
|--------------------|---|
| Protective circuit | Polarity reversal protection<br>Short circuit protected |
|--------------------|---|

### Performance data

|                      |  |
|----------------------|--|
| Supply voltage $U_B$ | 10 ... 30 V, DC, Incl. residual ripple |
| Residual ripple      | 0 ... 15 %, From $U_B$                 |
| Open-circuit current | 0 ... 15 mA                            |

### Outputs

|                                     |            |
|-------------------------------------|------------|
| Number of digital switching outputs | 1 Piece(s) |
|-------------------------------------|------------|

### Switching outputs

|                         |   |
|-------------------------|---|
| Type                    | Digital switching output                      |
| Voltage type            | DC  |
| Switching current, max. | 100 mA  |
| Switching voltage       | high: $\geq(U_B - 2.5V)$<br>low: $\leq 2.5 V$ |

### Switching output 1

|                     |                     |
|---------------------|---------------------|
| Assignment          | Connection 1, pin 4 |
| Switching element   | Transistor, PNP     |
| Switching principle | Dark switching      |

### Time behavior

|                     |        |
|---------------------|--------|
| Switching frequency | 500 Hz |
| Response time       | 1 ms   |
| Readiness delay     | 300 ms |

### Connection

|                       |            |
|-----------------------|------------|
| Number of connections | 1 Piece(s) |
|-----------------------|------------|

### Connection 1

|                    |                              |
|--------------------|------------------------------|
| Function           | Signal OUT<br>Voltage supply |
| Type of connection | Connector                    |
| Thread size        | M12                          |
| Type               | Male                         |
| Material           | Plastic                      |
| No. of pins        | 4 -pin                       |
| Encoding           | A-coded                      |

### Mechanical data

|  |                           |
|--|---------------------------|
| Dimension (W x H x L)                          | 15 mm x 46.5 mm x 31.8 mm |
| Thread size                                    | M18                       |
| Housing material                               | Plastic                   |
| Plastic housing                                | ABS                       |
| Lens cover material                            | Plastic                   |
| Net weight                                     | 75 g                      |
| Housing color                                  | Black<br>Red              |
| Recommended tightening torque for M3 fastening | 0.9 N·m                   |

### Operation and display

|                 |            |
|-----------------|------------|
| Type of display | LED        |
| Number of LEDs  | 2 Piece(s) |

### Environmental data

|                                |               |
|--------------------------------|---------------|
| Ambient temperature, operation | -40 ... 60 °C |
| Ambient temperature, storage   | -40 ... 70 °C |

### Certifications

|                      |               |
|----------------------|---------------|
| Degree of protection | IP 67         |
| Protection class     | III           |
| Approvals            | c UL US       |
| Standards applied    | IEC 60947-5-2 |

### Classification

|                       |          |
|-----------------------|----------|
| Customs tariff number | 85365019 |
| ECLASS 5.1.4          | 27270901 |
| ECLASS 8.0            | 27270901 |
| ECLASS 9.0            | 27270901 |
| ECLASS 10.0           | 27270901 |
| ECLASS 11.0           | 27270901 |
| ECLASS 12.0           | 27270901 |
| ECLASS 13.0           | 27270901 |
| ECLASS 14.0           | 27270901 |
| ECLASS 15.0           | 27270901 |
| ECLASS 16.0           | 27270901 |
| ETIM 5.0              | EC002716 |
| ETIM 6.0              | EC002716 |
| ETIM 7.0              | EC002716 |
| ETIM 8.0              | EC002716 |
| ETIM 9.0              | EC002716 |
| ETIM 10.0             | EC002716 |

# Dimensioned drawings

All dimensions in millimeters

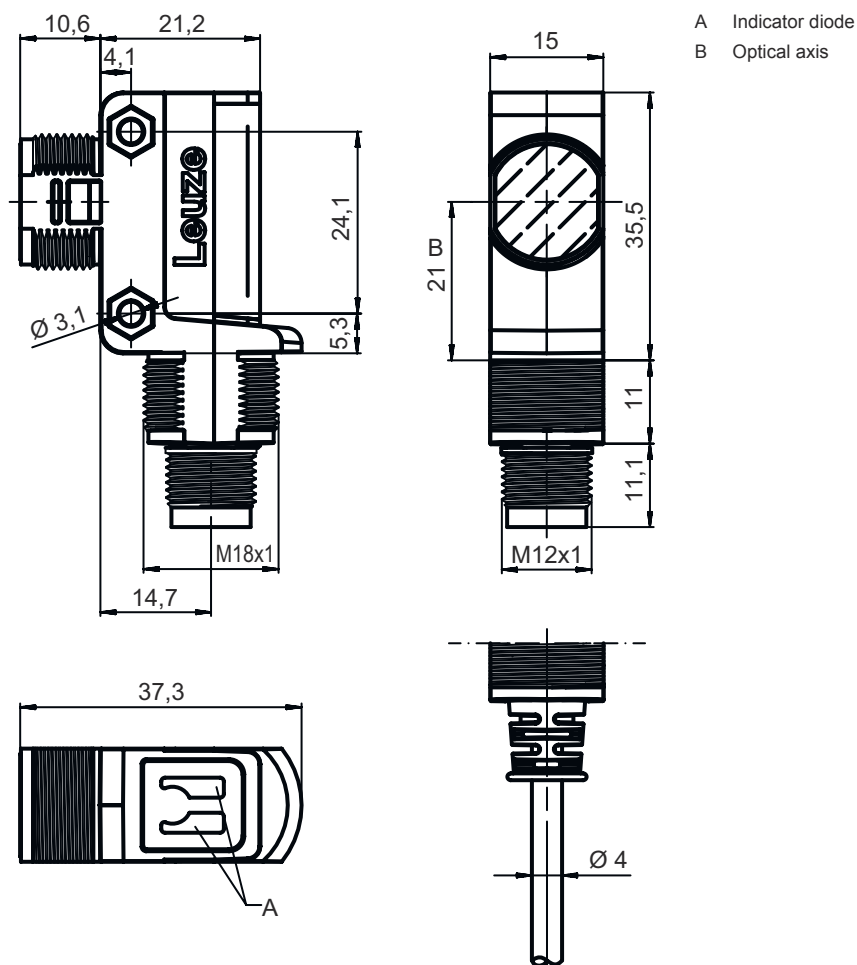

## Electrical connection

### Connection 1

|                    |                |
|--------------------|----------------|
| Function           | Signal OUT     |
|                    | Voltage supply |
| Type of connection | Connector      |
| Thread size        | M12            |
| Type               | Male           |
| Material           | Plastic        |
| No. of pins        | 4 -pin         |
| Encoding           | A-coded        |

### Pin Pin assignment

|   |       |
|---|-------|
| 1 | V+    |
| 2 | n.c.  |
| 3 | GND   |
| 4 | OUT 1 |

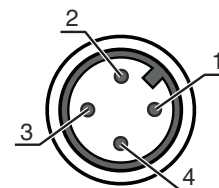

# Diagrams

## Typ. response behavior

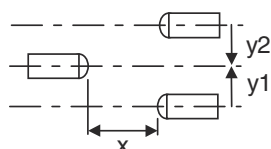
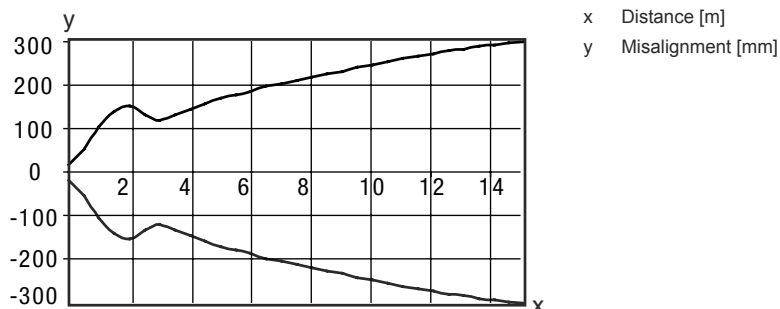

## Operation and display

| LED | Display                  | Meaning               |
|-----|--------------------------|-----------------------|
| 1   | Green, continuous light  | Operational readiness |
| 2   | Yellow, continuous light | Light path free       |
|     | Yellow, flashing         | No function reserve   |

## Suitable transmitters

|  | Part no. | Designation | Operating range<br>Operating range limit | Description  |
|--|----------|-------------|--|--|
|  | 50117928 | LS28/9D-M12 | 0 ... 10 m<br>0 ... 15 m                 | Special version: Deactivation input<br>Operating range limit: 0 ... 15 m<br>Light source: LED, Red<br>Supply voltage: DC<br>Deactivation inputs: 2 Piece(s)<br>Connection: Connector, M12, Plastic, 4 -pin |

## Part number code

Part designation: **AAA28D-E.F/GG-HH**

|              |   |
|--------------|---|
| <b>AAA28</b> | <b>Operating principle / construction</b><br>LS28: throughbeam photoelectric sensor transmitter<br>LE28: throughbeam photoelectric sensor receiver<br>ET28: energetic diffuse reflection sensor<br>FT28: diffuse reflection sensor with fading<br>PRK28: retro-reflective photoelectric sensor with polarization filter |
| <b>d</b>     | <b>Light type</b><br>n/a: red light<br>l: infrared light  |
| <b>E</b>     | <b>Preset range (optional)</b><br>n/a: operating range acc. to data sheet<br>xxxF: Preset range [mm]  |
| <b>F</b>     | <b>Equipment</b><br>3: teach-in via button  |

## Part number code

|           |  |
|-----------|--|
| <b>GG</b> | <b>Switching output / function (OUT1 = pin 4, OUT2 = pin 2):</b><br>2: NPN transistor output, light switching<br>N: NPN transistor output, dark switching<br>4: PNP transistor output, light switching<br>P: PNP transistor output, dark switching<br>9: deactivation input (deactivation with high signal)<br>D: Input for transmitter deactivation (deactivation with LOW signal)<br>X: pin not used |
| <b>HH</b> | <b>Electrical connection</b><br>n/a: cable, standard length 2000 mm, 4-wire<br>200-M8: cable, length 200 mm with M8 connector, 4-pin, axial (plug)<br>200-M12: cable, length 200 mm with M12 connector, 4-pin, axial (plug)  |

### Note



A list with all available device types can be found on the Leuze website at [www.leuze.com](http://www.leuze.com).

## Notes



### Observe intended use!



- ⌘ This product is not a safety sensor and is not intended as personnel protection.
- ⌘ The product may only be put into operation by competent persons.
- ⌘ Only use the product in accordance with its intended use.

### For UL applications:



- ⌘ For UL applications, use is only permitted in Class 2 circuits in accordance with the NEC (National Electric Code).
- ⌘ These proximity switches shall be used with UL Listed Cable assemblies rated 30V, 0.5A min, in the field installation, or equivalent (categories: CYJV/ CYJV7 or PVVA/PVVA7)

## Further information

- Sum of the output currents for both outputs, 50 mA for ambient temperatures > 40 °C

## Accessories

### Connection technology - Connection cables

|  | Part no. | Designation        | Article          | Description  |
|--|----------|--------------------|------------------|--|
|  | 50130652 | KD U-M12-4A-V1-050 | Connection cable | Application: Chemical resistant<br>Connection 1: Connector, M12, Axial, Female, A-coded, 4 -pin<br>Connector, LED: No<br>Connection 2: Open end<br>Shielded: No<br>Cable length: 5,000 mm<br>Sheathing material: PVC |



## Accessories

|  | Part no. | Designation        | Article          | Description  |
|--|----------|--------------------|------------------|--|
|  | 50130690 | KD U-M12-4W-V1-050 | Connection cable | Application: Chemical resistant<br>Connection 1: Connector, M12, Angled, Female, A-coded, 4 -pin Connector, LED: No<br>Connection 2: Open end<br>Shielded: No<br>Cable length: 5,000 mm<br>Sheathing material: PVC |

## Mounting technology - Mounting brackets

|  | Part no. | Designation   | Article             | Description   |
|--|----------|---------------|---------------------|---|
|  | 50124651 | BT 205M-10SET | Mounting device set | Contains: 10x<br>Design of mounting device: Angle, L-shape<br>Fastening, at system: Through-hole mounting<br>Mounting bracket, at device: Screw type<br>Type of mounting device: Rigid<br>Material: Metal |

## Mounting technology - Rod mounts

|  | Part no. | Designation  | Article         | Description   |
|--|----------|--------------|-----------------|---|
|  | 50117255 | BTU 200M-D12 | Mounting system | Contains: 2x M3 x 16 screw, 2 M3 x 20 screws, 2x position washers<br>Design of mounting device: Mounting system<br>Fastening, at system: For 12 mm rod, Sheet-metal mounting<br>Mounting bracket, at device: Screw type, Suited for M3 screws<br>Type of mounting device: Clampable, Adjustable, Turning, 360°<br>Material: Metal |
|  | 50117490 | BTU D18M-D12 | Mounting system | Design of mounting device: Mounting system<br>Fastening, at system: Through-hole mounting<br>Mounting bracket, at device: Screw type<br>Type of mounting device: Clampable, Adjustable, Turning, 360°<br>Material: Metal  |

### Note



A list with all available accessories can be found on the Leuze website in the Download tab of the article detailed page.