

## Technical data sheet

### Safety light curtain receiver

Part no.: 68025307  
MLC511R30-750.1



For illustration purposes only

#### Contents

- Technical data
- Dimensioned drawings
- Electrical connection
- Circuit diagrams
- Operation and display
- Suitable transmitters
- Part number code
- Notes
- Accessories



## Technical data

### Basic data

Series	MLC 500
Device type	Receiver
Contains	2x BT-NC sliding block
Application	Hand protection

### Functions

Function package	Basic
Functions	Automatic start/restart Transmission channel changeover

### Characteristic parameters

Type	4, IEC/EN 61496
SIL	3, IEC 61508
SILCL	3, IEC/EN 62061
Performance Level (PL)	e, EN ISO 13849-1
PFH <sub>D</sub>	7.73E-09 per hour
Mission time T <sub>M</sub>	20 years, EN ISO 13849-1
Category	4, EN ISO 13849

### Protective field data

Resolution	30 mm
Protective field height	750 mm

### Optical data

Synchronization	Optical between transmitter and receiver
-----------------	--

### Electrical data

Protective circuit	Overtoltage protection Short circuit protected
--------------------	---

### Performance data

Supply voltage U <sub>B</sub>	24 V, DC, -20 ... 20 %
Current consumption, max.	150 mA
Fuse	2 A semi time-lag

### Outputs

Number of safety-related switching outputs (OSSDs)	2 Piece(s)
--	------------

### Safety-related switching outputs

Type	Safety-related switching output OSSD
Switching voltage high, min.	18 V
Switching voltage low, max.	2.5 V
Switching voltage, typ.	22.5 V
Voltage type	DC
Current load, max.	380 mA
Load inductivity	2,000 µH
Load capacity	0.3 µF
Residual current, max.	0.2 mA
Residual current, typ.	0.002 mA
Voltage drop	1.5 V

### Safety-related switching output 1

Assignment	Connection 1, pin 2
Switching element	Transistor, PNP

### Safety-related switching output 2

Assignment	Connection 1, pin 4
Switching element	Transistor, PNP

### Time behavior

Response time	14 ms
Restart delay time	100 ms

### Connection

Number of connections	1 Piece(s)
-----------------------	------------

### Connection 1

Function	Machine interface
Type of connection	Connector
Thread size	M12
Material	Metal
No. of pins	4 -pin

### Cable properties

Permissible conductor cross section, typ.	0.25 mm <sup>2</sup>
Length of connection cable, max.	100 m
Permissible cable resistance to load, max.	200 Ω

### Mechanical data

Dimension (W x H x L)	29 mm x 816 mm x 35.4 mm
Housing material	Metal
Metal housing	Aluminum
Lens cover material	Plastic / PMMA
Material of end caps	Diecast zinc
Net weight	900 g
Housing color	Yellow, RAL 1021
Type of fastening	Groove mounting Mounting brackets Mounting on Device Column Swivel mount

### Operation and display

Type of display	LED
Number of LEDs	2 Piece(s)

### Environmental data

Ambient temperature, operation	0 ... 55 °C
Ambient temperature, storage	-30 ... 70 °C
Relative humidity (non-condensing)	0 ... 95 %

### Certifications

Degree of protection	IP 65
Protection class	III
Certifications	c TÜV NRTL US c UL US KCs TÜV Süd
Vibration resistance	50 m/s <sup>2</sup>
Shock resistance	100 m/s <sup>2</sup>
US patents	US 6,418,546 B

## Technical data

Customs tariff number	85365019
ECLASS 5.1.4	27272704
ECLASS 8.0	27272704
ECLASS 9.0	27272704
ECLASS 10.0	27272704
ECLASS 11.0	27272704
ECLASS 12.0	27272704
ECLASS 13.0	27272704
ECLASS 14.0	27272704
ETIM 5.0	EC002549
ETIM 6.0	EC002549
ETIM 7.0	EC002549
ETIM 8.0	EC002549
ETIM 9.0	EC002549

## Dimensioned drawings

All dimensions in millimeters

Calculation of the effective protective field height  $H_{PFE} = H_{PFN} + B + C$

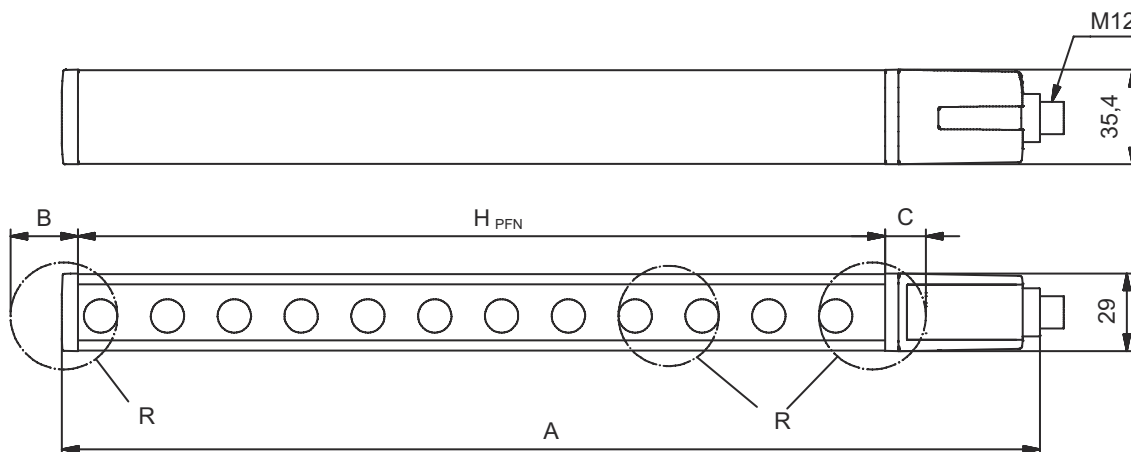

$H_{PFE}$  Effective protective field height = 778 mm

$H_{PFN}$  Nominal protective field height = 750 mm

A Total height = 816 mm

B 19 mm

C 9 mm

R Effective protective field height  $H_{PFE}$  goes beyond the dimensions of the optics area to the outer borders of the circles labeled with R.

## Electrical connection

### Connection 1

Function	Machine interface
Type of connection	Connector
Thread size	M12
Type	Male
Material	Metal
No. of pins	4 -pin
Encoding	A-coded
Connector housing	FE/SHIELD

# Electrical connection

Pin	Pin assignment	Conductor color
1	VIN1	Brown
2	OSSD2	White
3	VIN2	Blue
4	OSSD1	Black

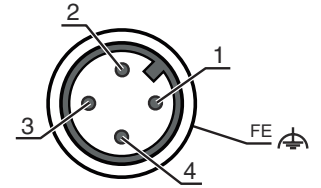

## Circuit diagrams

### Connection diagram receiver

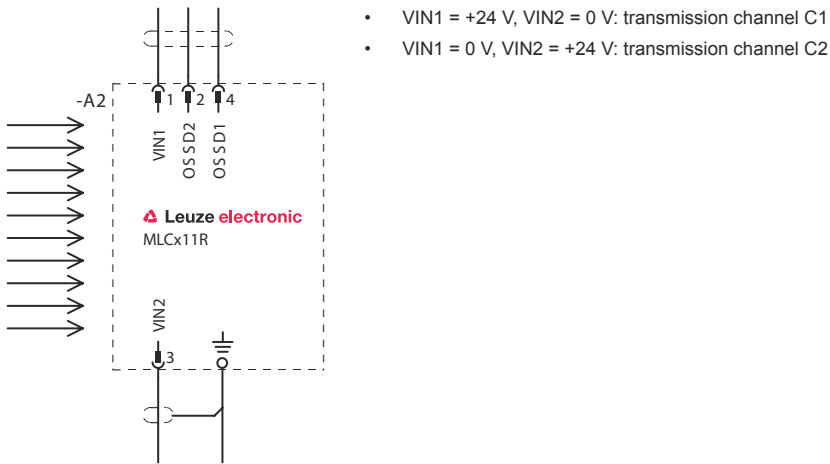

### Circuit diagram example with downstream MSI-SR4B safety relay

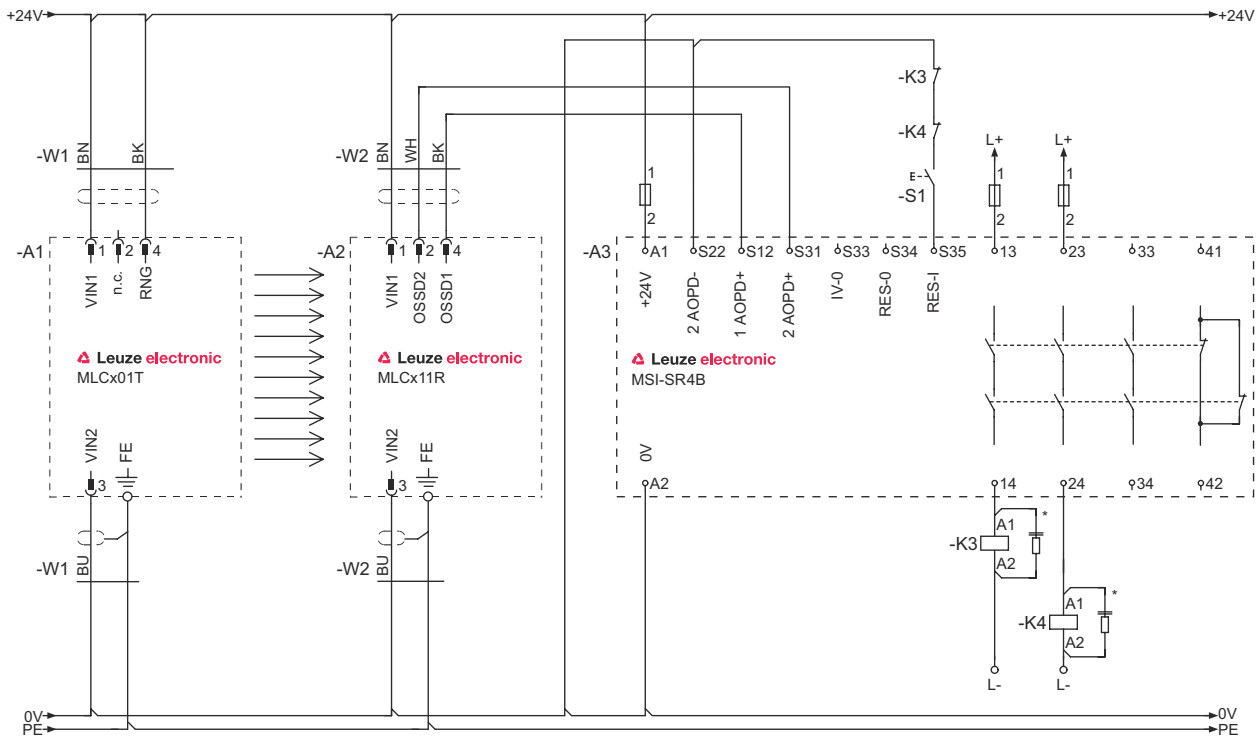

# Operation and display

LED	Display	Meaning
1	Off	Device switched off
	Red, continuous light	OSSD off.
	Red, flashing, 1 Hz	External error
	Red, flashing, 10 Hz	Internal error
	Green, flashing, 1 Hz	OSSD on, weak signal
	Green, continuous light	OSSD on
2	Off	Transmission channel C1
	Red, continuous light	OSSD off, transmission channel C2

## Suitable transmitters

	Part no.	Designation	Article	Description
	68004307	MLC501T30-750	Safety light curtain transmitter	Resolution: 30 mm Protective field height: 750 mm Operating range: 0 ... 10 m Connection: Connector, M12, Metal, 4 -pin

## Part number code

Part designation: MLCxyy-za-hhhhei-ooo



MLC	Safety light curtain
x	<b>Series</b> 3: MLC 300 5: MLC 500
yy	<b>Function classes</b> 00: transmitter 01: transmitter (AIDA) 02: transmitter with test input 10: basic receiver - automatic restart 11: basic receiver - automatic restart (AIDA) 20: standard receiver - EDM/RES selectable 30: extended receiver - blanking/muting
z	<b>Device type</b> T: transmitter R: receiver
a	<b>Resolution</b> 14: 14 mm 20: 20 mm 30: 30 mm 40: 40 mm 90: 90 mm
hhhh	<b>Protective field height</b> 150 ... 3000: from 150 mm to 3000 mm
e	<b>Host/Guest (optional)</b> H: Host MG: Middle Guest G: Guest
i	<b>Interface (optional)</b> /A: AS-i
ooo	<b>Option</b> /V: high Vibration-proof EX2: explosion protection (zones 2 + 22) SPG: Smart Process Gating

### Note



A list with all available device types can be found on the Leuze website at [www.leuze.com](http://www.leuze.com).

## Notes

 <b>Observe intended use!</b>	
	<ul style="list-style-type: none"> <li>↳ The product may only be put into operation by competent persons.</li> <li>↳ Only use the product in accordance with its intended use.</li> </ul>

## Accessories



### Connection technology - Connection cables

	Part no.	Designation	Article	Description
	50130726	KD S-M12-4A-P1-050	Connection cable	Connection 1: Connector, M12, Axial, Female, A-coded, 4 -pin Connector, LED: No Connection 2: Open end Shielded: Yes Cable length: 5.000 mm Sheathing material: PUR

### Mounting technology - Swivel mounts

	Part no.	Designation	Article	Description
	429393	BT-2HF	Mounting bracket set	Fastening, at system: Through-hole mounting Mounting bracket, at device: Clampable Type of mounting device: Turning, 360° Material: Metal, Plastic

## Services

	Part no.	Designation	Article	Description
	S981050	CS40-I-140	Safety inspection	Details: Checking of a safety light barrier application in accordance with current standards and guidelines. Inclusion of the device and machine data in a database, production of a test log per application. Conditions: It must be possible to stop the machine, support provided by customer's employees and access to the machine for Leuze employees must be ensured.
	S981046	CS40-S-140	Start-up support	Details: For safety devices including stopping time measurement and initial inspection. Conditions: Devices and connection cables are already mounted, price not including travel costs and, if applicable, accommodation expenses.

#### Note

	↳ A list with all available accessories can be found on the Leuze website in the Download tab of the article detailed page.
--	---