

the sensor people

ECO

Safety Light Curtains

(SERIES E30, E55, E80)



601526 - 2010/06
We reserve the right to
make technical chan-
ges

Regarding these connecting and operating instructions



These connecting and operating instructions contain information on the appropriate operation of ECO Safety Light Curtains. It is supplied to the customer along with the delivered system.

Safety precautions and warnings are designated by the symbol .

Leuze electronic GmbH + Co. is not liable for damage resulting from improper use of its equipment. Acquaintance with these instructions constitutes part of the knowledge required for proper use.

© These connecting and operating instructions may not be reprinted or copied, in full or in part, without the express permission of:

Leuze electronic GmbH + Co. KG
In der Braike 1
D-73277 Owen - Teck / Germany
Telefon +49 (0) 7021 / 573-0
Fax +49 (0) 7021 / 573-199
info@leuze.de
www.leuze.com

Contents

1	System Overview and Range of Applications	4
1.1	System Overview	4
1.2	Approvals	4
1.3	Device Types and Range of Applications	5
2	Safety	7
2.1	Approved purpose and foreseeable improper operation	7
2.2	Competent personnel	9
2.3	Responsibility for safety	9
2.4	Exemption of liability	9
2.5	Special Safety Instructions for Use of Type 2 Protective Devices	10
3	Design and Function	11
3.1	System Overview	11
3.2	Operating Mode	11
3.3	Cascading	11
3.4	Display Elements	13
3.5	Separate Transmission Channels to Prevent Mutual Interference	13
3.6	Test Input	13
3.7	OSSD Switch Output	14
3.8	Contamination and Fault Signal Output	14
3.9	Diagnostic Function	14
4	Installation	16
4.1	General Installation Procedures	16
4.2	Mounting Procedures for ECO Light Curtains (Series E30)	18
4.3	Mounting Procedures for ECO Light Curtains used for the Horizontal Safeguarding of Danger Areas (Series E55 and E80)	19
4.4	Mechanical Installation	20
5	Electrical Installation	22
5.1	Installation Procedures	22
5.2	Power Supply	22
5.3	Connecting Cables	22
5.4	Connecting Examples	23
6	Device Start-up	26
7	Cleaning	27
8	Technical Data and Dimensional Drawing	28
9	Selection and Ordering information	32
9.1	Selecting an ECO Safety Light Curtain or Light Curtain	32
9.2	Ordering Information	32
9.3	Scope of Delivery and Accessories	33

1 System Overview and Range of Applications

1.1 System Overview

ECO is a product group consisting of testable safety light curtains. In combination with a test monitoring unit such as the Leuze electronic TNT 35, MSI-s/R, or MSI-m/R (for muting), ECO devices qualify as an active optoelectronic protective device (AOPD), Type 2, in accordance with IEC 61496-1, -2 or EN 61496-1, -2. ECO light curtains have many outstanding features, including:

- Extremely compact design (17 mm x 33 mm)
- Interference between adjacent devices can be avoided by selecting separate transmission channels
- Simple to connect using an M12 connector
- Possible to integrate a stepping-behind protection by cascading several units
- Functions (e.g. restart interlock, muting) can be flexibly expanded by adding Type 2 test monitoring units TNT 35 or MSI safety interface components
- Self-diagnosis system for PC-supported displays and diagnostics
- Contamination and error signal output to the SPS

1.2 Approvals

EU Prototype Testing (Europe)

TÜV PRODUCT SERVICE GMBH
Ridlerstraße 65
D-80339 Munich
Germany

IEC- respectively EN 61496-2 testing conducted by:

BIA Berufsgenossenschaftliches Institut für Arbeitssicherheit
(Trade Association Institute for Industrial Safety)
Alte Heerstraße 111
D-53757 St. Augustin
Germany



1.3 Device Types and Range of Applications

ECO safety light curtains are available in series E30 to provide hand protection, in series E55 and E80 to safeguard danger zones, and in combination as a cascaded design. Typical application areas are:

- Textile machines such as power looms, sectional warping machines or beam warping machines
- Warehouse technology, such as paternosters for shelving
- Automatic assembly machines for circuit boards
- Corpus presses in the timber industry
- Packaging machines
- Shoe machines
- Rotary-cycle machines

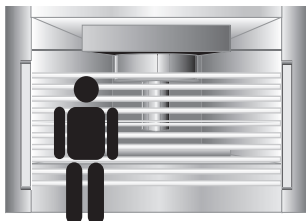

ECO Light Curtains, Series E30, for providing hand protection at danger points

Resolution:	30 mm (hand)
Protection range:	0.3 ... 6 m *
Protecting heights:	150, 225, 300, 450, 600, 750, ... 1800 mm (up to 3000 mm upon request)

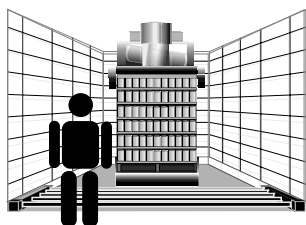

ECO Light Curtains, Series E55, for safeguarding danger zones close to floor level (75 mm and higher)

Resolution:	55 mm (shin)
Protected range:	0.3 ... 6 m *
Protected heights:	300, 450, 600, ..., 1800 mm (up to 3000 mm upon request)

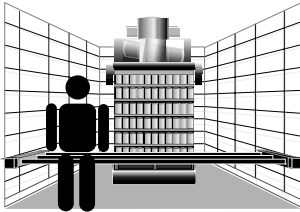

ECO-Light Curtains, Series E 80, for safeguarding danger zones at heights of 450 mm and above

Resolution:	80 mm (leg)
Protected range:	0.3 ... 6 m *)
Protected heights:	450, 600, 900, 1200, 1500, 1800 mm (up to 3000 mm upon request)



ECO Light Curtains in a cascaded design for providing hand protection and stepping behind protection at danger points

Resolution of Master unit:	30 mm, 55 mm, or 80 mm
Resolution of Slave unit:	30 mm, 55 mm, or 80 mm
Protected range:	0.3 ... 6 m *)
Protected heights/Master:	300, 450, 600, 750, ..., 1800 mm
Protected heights/Slave:	150, 225, 300, 450, 600, 750, ..., 1800 mm

*) Multi-sided danger point protection can be achieved by implementing deflective mirrors. In this case, the range is reduced by approx. 10 % per mirror.

2 Safety

Before using the safety sensor, a risk evaluation must be performed according to valid standards (e.g. EN ISO 14121, EN ISO 12100-1, EN 954-1). The result of the risk assessment determines the required safety level of the safety sensor (see Tabelle 2.1-1). For mounting, operating and testing, document "ECO Safety Light Curtain" as well as all applicable national and international standards, regulations, rules and directives must be observed. Relevant and supplied documents must be observed, printed out and handed to the affected personnel.

Before working with the safety sensor, completely read and understand the documents applicable to your task.

In particular, the following national and international legal regulations apply for the start-up, technical inspections and work with safety sensors:

- Machinery directive 2006/42/EC
- Low voltage directive 2006/95/EC
- Electromagnetic compatibility directive 2004/108/EC
- Use of Work Equipment Directive 89/655/EEC supplemented by Directive 95/63 EC
- OSHA 1910 Subpart O
- Safety regulations
- Accident-prevention regulations and safety rules
- Ordinance on Industrial Safety and Health and Labor Protection Act
- Device Safety Act



Notice!

For safety-related information you may also contact the local authorities (e.g., industrial inspectorate, employer's liability insurance association, labor inspectorate, occupational safety and health authority).

2.1 Approved purpose and foreseeable improper operation



Warning!

A running machine can cause severe injuries!

Make certain that, during all conversions, maintenance work and inspections, the system is securely shut down and protected against being restarted again.

2.1.1 Proper use

The safety sensor must only be used after it has been selected in accordance with the respectively applicable instructions and relevant standards, rules and regulations regarding labor protection and occupational safety, and after it has been installed on the machine, connected, commissioned, and checked by a competent person.

When selecting the safety sensor it must be ensured that its safety-related capability meets or exceeds the required category ascertained in the risk assessment.

The following table shows the safety-related characteristic parameters of the ECO Safety Light Curtain.

Type in accordance with IEC/EN 61496	Type 2
Category in accordance with EN 954-1	Cat. 2
Service life (T_M)	20 years

Table 2.1-1: Safety-related characteristic parameters of the ECO Safety Light Curtain

- The safety sensor protects persons at access points or at points of operation of machines and plants.
- When mounted vertically, the safety sensor detects the penetration by fingers and hands at hazard locations (resolution <40 mm) or by the body at access points.
- The safety sensor only detects persons upon entry to the danger zone; it does not detect persons who are located within the danger zone. For this reason, a start/restart interlock is mandatory.
- The safety sensor with horizontal mounting detects persons who are located within the danger zone (presence detection).
- The construction of the safety sensor must not be altered. When manipulating the safety sensor, the protective function is no longer guaranteed. Manipulating the safety sensor also voids all warranty claims against the manufacturer of the safety sensor.
- The safety sensor must be tested regularly by competent personnel.
- The safety sensor must be exchanged after a maximum of 20 years. Repairs or the exchange of parts subject to wear and tear do not extend the service life.
- The ECO Safety Light Curtains are to be mounted in such a way that it is not possible to reach over, under or step behind the protective field. If this is not ensured, additional protective equipment must be installed.

2.1.2 Foreseeable misuse

Any use other than that defined under the "intended use" or which goes beyond that use is considered improper use!

e.g.:

- danger of objects being expelled or hot or dangerous liquids spurting from the danger zone
- applications in explosive or easily flammable atmospheres

2.2 Competent personnel

Prerequisites for competent personnel:

- he has a suitable technical education
- he knows the rules and regulations for occupational safety, safety at work and safety technology and can assess the safety of the machine
- he knows the instructions for the safety sensor and the machine
- he has been instructed by the responsible person on the mounting and operation of the machine and of the safety sensor

2.3 Responsibility for safety

Manufacturer and operating company must ensure that the machine and implemented safety sensor function properly and that all affected persons are adequately informed and trained.

The type and content of all imparted information must not lead to unsafe actions by users.

The manufacturer of the machine is responsible for:

- safe machine construction
- safe implementation of the safety sensor
- imparting all relevant information to the operating company
- adhering to all regulations and directives for the safe starting-up of the machine

The company operating the machine is responsible for:

- instructing the operating personnel
- maintaining the safe operation of the machine
- adhering to all regulations and directives for occupational safety and safety at work
- regular testing by competent personnel

2.4 Exemption of liability

Leuze electronic GmbH + Co. KG is not liable in the following cases:

- safety sensor is not used as intended
- safety notices are not adhered to
- reasonably foreseeable misuse is not taken into account
- mounting and electrical connection are not properly performed
- proper function is not tested
- changes (e.g., constructional) are made to the safety sensor

2.5 Special Safety Instructions for Use of Type 2 Protective Devices



Attention!

- type 2 protective equipment is only to be used if a machine-specific C standard permits such use or if the risk evaluation acc. to EN ISO 14121 or EN 954-1, figures C1 and E1, yields a low to medium risk level (II or III).
- For Type 2-protective devices, the protective effect is checked by periodic testing. A defect occurring between the test cycles can result in a temporary loss of the protective function which will not be detected until the next test.
Hence, shorter intervals between tests ensure higher availability of the protective function. Organizations responsible for machine safety, such as the expert committees of trade associations, can provide assistance in this regard. The Leuze electronic test monitoring unit TNT 35 or the MSI safety interface components provide optimal Type 2 functional safety; see Chapter 5 „Electrical installation“.

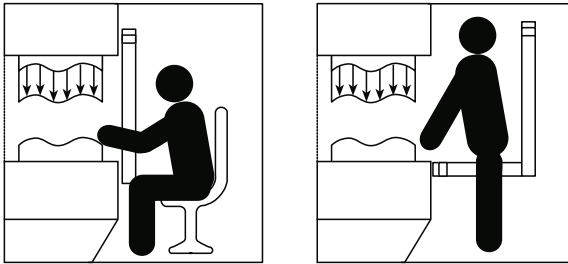

Fig. 1 Access from above, beneath or behind must be impossible

- It must be possible to intervene in the machine controls by electrical means so that potentially hazardous conditions in each working phase can be terminated immediately.
- The safety clearance between the danger point and the sensing zone must be sufficiently large so that the potentially hazardous condition is terminated before the person has reached the danger point (refer to chapter 5).

3 Design and Function

3.1 System Overview

Configured on a modular basis, ECO safety light curtains consist of a transmitter containing a row of IR radiation elements and a receiver containing a row of receiver elements. These elements are sequentially controlled and evaluated in quick succession.

The transmitter and receiver are optically synchronized; it is not necessary to link the two components with a cable. If the ECO is used as a Type 2 protective device, an external test monitoring unit emits a periodic test signal in order to trigger a system test which checks the correct response of the receiver. The Leuze electronic TNT 35 or MSI safety interface components, e.g. the MSI-s/R, can function as this test monitoring unit. The particular advantage of these units is that the periodic functional test is performed cyclically in the background, without hindering the production output of the protected machinery.

3.2 Operating Mode

ECO safety light curtains function in the mode „protective operation without restart interlock“. If sufficient receiver signal is present at all light axes, the output voltage at the OSSD output is switched to +24V DC. If one or more light axes are interrupted, the OSSD output is shut off within the system response time. As soon as all the light axes are unobstructed again, the output automatically reverts to +24V DC.

3.3 Cascading

By connecting ECO master and slave units in succession, it is possible to link up two or more sensing zones. Master and slave units with different resolutions can be connected to one another.

Master units M

E30	-300 M, -450 M, -600 M, -750 M, -900 M, -1050 M, -1200 M, -1350 M, -1500 M, -1650 M, -1800 M
E55	-450 M, -600 M, -750 M, -900 M, -1050 M, -1200 M, -1350 M, -1500 M, -1650 M, -1800 M
E80	-450 M, -600 M, -900 M, -1200 M, -1500 M, -1800 M

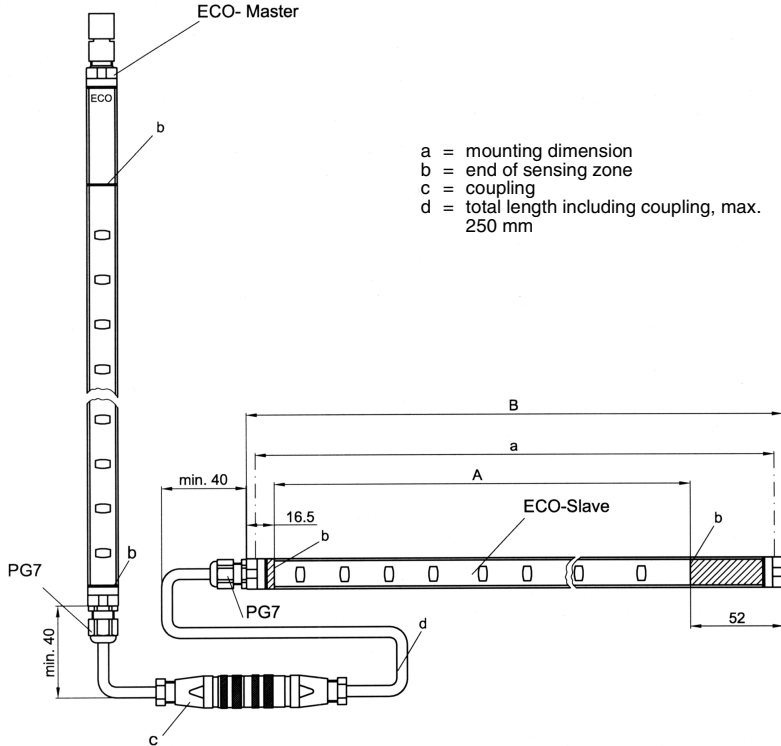

Fig. 2 Dimensional drawing „Cascaded design“

Slave units S

E30	-150 S, -225 S, -300 S, -450 S, -600 S, -750 S, -900 S, -1050 S, -1200 S, -1350 S, -1500 S, -1650 S, -1800 S
E55	-300 S, -450 S, -600 S, -750 S, -900 S, -1050 S, -1200 S, -1350 S, -1500 S, -1650 S, -1800 S
E80	-450 S, -600 S, -900 S, -1200 S, -1500 S, -1800 S

3.4 Display Elements

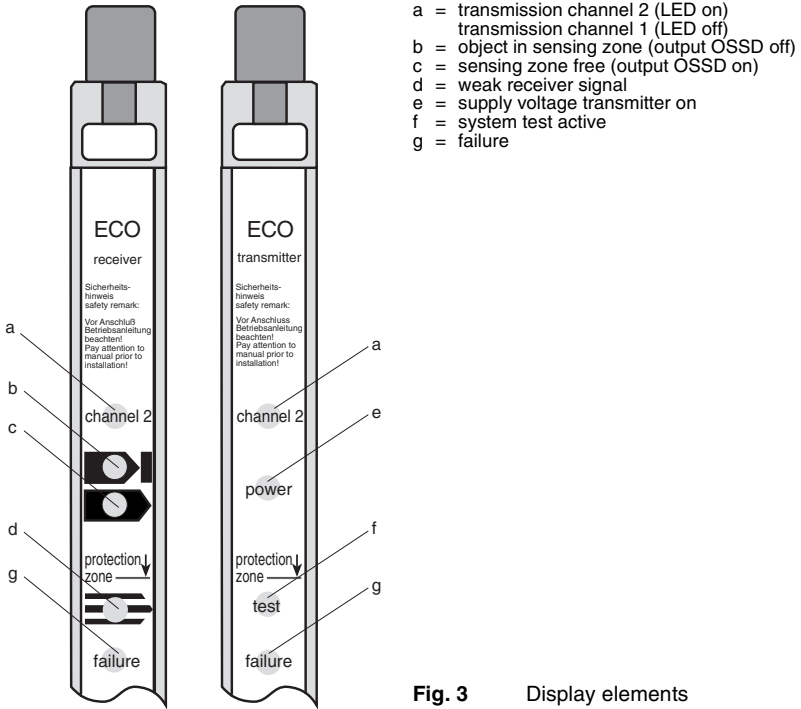

Fig. 3 Display elements

3.5 Separate Transmission Channels to Prevent Mutual Interference

Functional disturbances can result from mutual interference caused by the optical cross-talk of adjacent units. In order to prevent these disturbance, two separate transmission channels can be selected by setting suitable polarities for the supply voltage cables. The transmitter and receiver of one system must each be connected with the same polarity (= transmission channel).

Channel 1 = white at +24V DC and green at 0 V;
 Channel 2 = white at 0 V and green at +24V DC.

3.6 Test Input

The ECO transmitter is equipped with an input for the periodic functional test (+24V DC = no test; high resistance or 0 V = test).

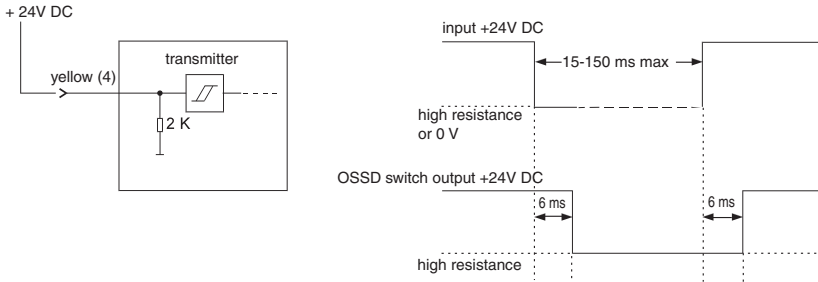

Fig. 4 ECO test input

3.7 OSSD Switch Output

The short circuit-proof +24V DC pnp switch output on the receiver is able to switch earthed loads of up to 0.1 A. Contactors or relays must be wired parallel to the coil with suitable spark absorbers.

3.8 Contamination and Fault Signal Output

This pnp output normally carries +24V DC. In case of a weak receiver signal caused by contamination or misalignment, or in case of a fault, the output is switched to high resistance. The output is short circuit-proof and can carry up to 70 mA.

3.9 Diagnostic Function

The self-diagnosis system integrated into the transmitter and receiver facilitates the device start-up as well as on-site fault localization. In case of a defective component, the „failure“ LED of the defective component lights up.

In addition, the receiver is equipped with an RS-485 interface. This allows it to be connected to a PC in the workshop so that the infrared light axes can be visualized on-site and detailed diagnostics can be performed.

The PC must be connected by means of an RS-485 / RS-232 interface converter, and its serial interface must be able to handle a transmission rate of up to 57.6 Kbaud.

The diagnostics software required for visualization can be run on Windows 3.1 and higher versions. Both the software and the interface converter are available as optional accessories.

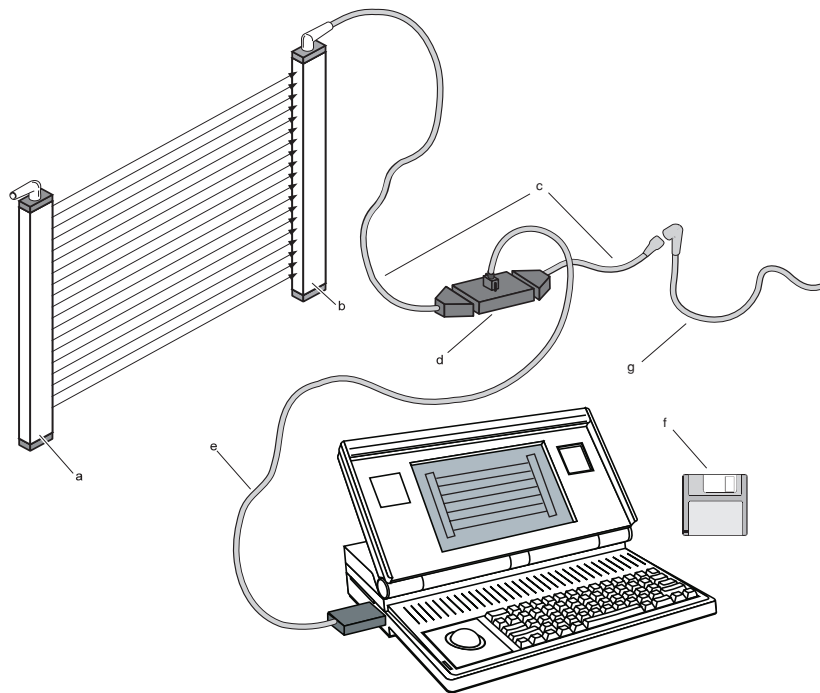

- a = ECO transmitter
- b = ECO receiver
- c = set of diagnosis cables with straight or angled connector
- d = RS-485/RS-232 Interface converter
- e = RS-232 cable
- f = ECO diagnostic software
- g = ECO receiver connecting cable (is removed for diagnosis, the interface converter is connected in series)

Fig. 5 Visualization and diagnostics by means of serial interface and PC

4 Installation

4.1 General Installation Procedures



Attention!

Pay close attention to the safety precautions described in Chapter 2. In general, all units must be installed so that the danger point can be reached only by passing through the sensing zone and that a sufficient clearance is maintained between the danger point and the sensing zone (see chapter 4.2 and 4.3).

4.1.1 Distance from Reflective Surfaces



Attention!

Reflective surfaces within the 8° transmission and reception cone can cause reflections that result in a non-detection of body parts. For this reason, a minimum distance (a) must be maintained between the optical axis of the ECO and reflective objects, such as polished machine parts or material receptacles. The following diagram shows the proper installation and the distance (a) as a dependency of the width of the sensing zone.

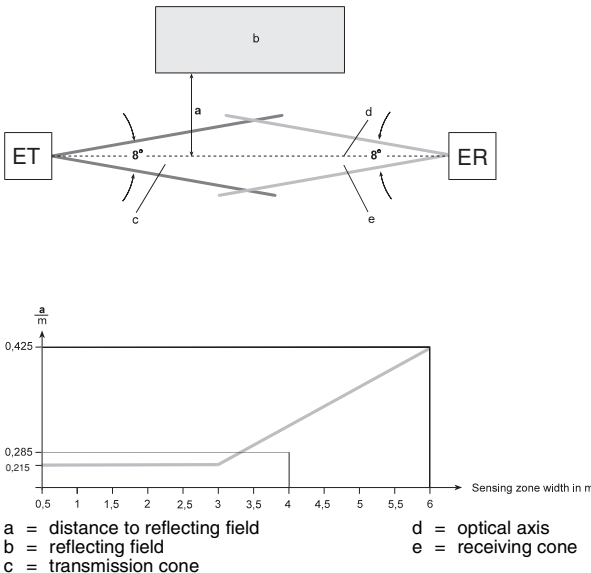

Fig. 6 A sufficiently large distance (a) from reflective surfaces must be assured. a [m] = 0.07 x protection zone width [m] + 0.005 m

4.1.2 Preventing Mutual Interference between Adjacent Devices



Attention!

When a receiver (receiver cone 8° full angle) is located in the beam path of an adjacent transmitter, the overlapping ranges can result in optical cross-talk. This in turn can lead to faulty switching or, in certain circumstances, even to a temporary breakdown of the protective function. In order to prevent this from happening, two separate transmission channels can be selected for adjacent devices (see chapter 3.5). The units can also be mounted in opposite directions or be separated by appropriate shielding.

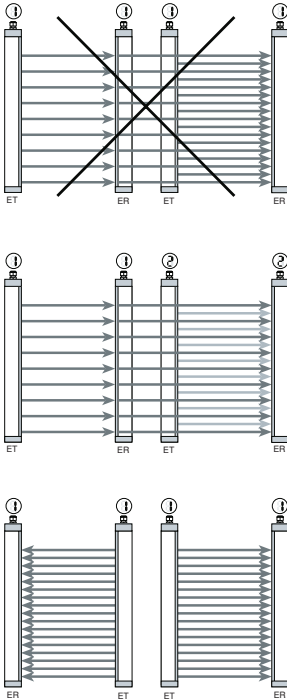

Fig. 7 Preventing mutual interference by selecting separate transmission channels

4.2 Mounting Procedures for ECO Light Curtains (Series E30)



Attention!

When mounting ECO safety light curtains for hand protection, it is essential that the sensing zone must be made inaccessible from above, below and the side. It must also be impossible to step behind the sensing zone. If necessary, supplemental mechanical grids must be installed, or multiple ECO units must be cascaded. The minimum protective clearance is calculated as follows:

$$S = (K \times T) + C$$

where:

- S** minimum clearance between the sensing zone and the danger point in mm ($S_{min} \geq 100$ mm)
- K** accessing rate 2 mm/ms
- T** machine lag time + response time of the optoelectronic protective device (AOPD) in ms
- C** 8 (d - 14 mm), but not less than 0
- d** detection capability (resolution) of the AOPD in mm

If this calculation results in a value for S that is greater than 500 mm, then the calculation may be repeated for K = 1.6 mm/ms. In this case, the value of S_{min} must not be less than 500 mm.

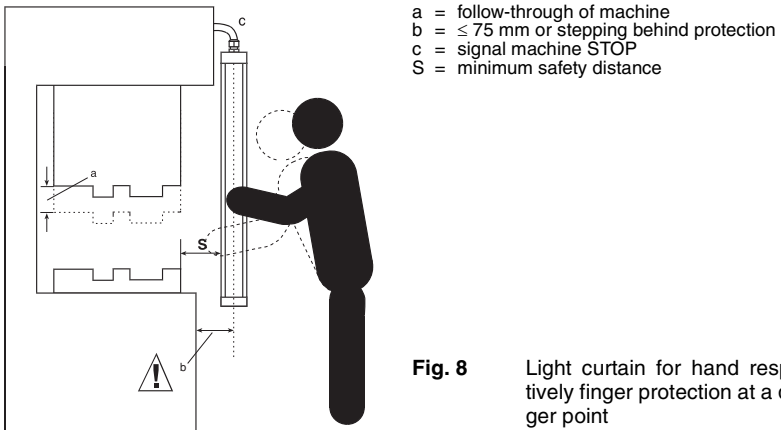

Fig. 8 Light curtain for hand respectively finger protection at a danger point

4.3 Mounting Procedures for ECO Light Curtains used for the Horizontal Safeguarding of Danger Areas (Series E55 and E80)



Attention!

When the light curtains are mounted horizontally, make sure that the height of the sensing zone does not exceed 1000 mm. If H exceeds 300 mm (200 mm if children are present), an undetected approach underneath the sensing zone is possible. This factor must be taken into account when the risk is assessed. The minimum protective clearance S and the installation height H are calculated as follows:

$$S = (1.6 \text{ mm/ms} \times T) + C$$

$$C = 1200 \text{ mm} - 0.4 \times H$$

where:

H = height of the sensing zone above the plane of reference

C_{min} = 850 mm

H_{max} = 1000 mm

H_{min} = 15 (d - 50 mm)

where:

d resolution of the AOPD

The following admissible heights for the ECO light curtains, as resulting from this calculation, are:

E55: H_{min} = 75 mm H_{max} = 1000 mm

E80: H_{min} = 450 mm H_{max} = 1000 mm

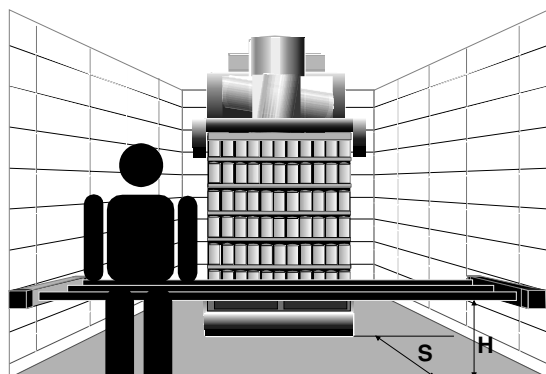

Fig. 9 Safety clearance and installation heights for the horizontal safeguarding of danger zones

4.4 Mechanical Installation

4.4.1 Standard Mounting

ECO units are mounted by means of through holes in the profile end pieces. (For the distance between holes, see the dimensional table on page 29 and the dimensional drawing on page 30). The holes have a diameter of 5.3 mm.

This fixed means of mounting is appropriate only when no adjustment is required (i.e. the mounting areas are located in one plane and the mounting positions are at the same height).

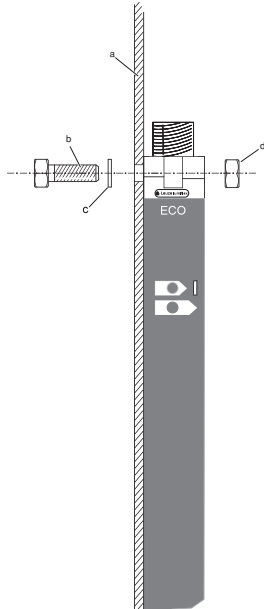

- a = attachment surface
- b = screw M5
- c = disk
- d = nut M5

Fig. 10 ECO standard mounting by using the through holes in the profile end pieces

4.4.2 Mounting Using the Protective Mounting Profile

To provide additional mechanical protection, the ECO can be snapped into a protective mounting profile. This is recommended for larger protected heights and when the unit needs to be adjustable. The protective mounting profile can be used with either a standard mounting plate or a swivelling mounting support with vibration damping.

Standard mounting bracket

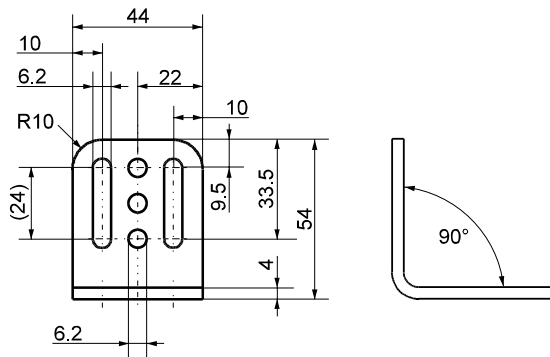

Swivel mounting support with vibration damping
(swivel range $\pm 8^\circ$)

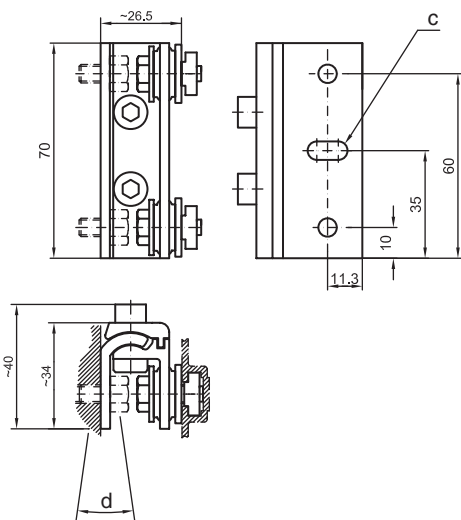

ECO with protective mounting profile

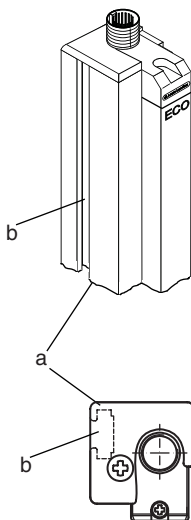

- a = ECO protective mounting profile
- b = longitudinal groove for freely positionable M6 T-slot nuts
- c = slot 13 x 6
- d = swivelling angle $\pm 8^\circ$

Fig. 11 Mechanical mounting by using the ECO protective and mounting profile

5 Electrical Installation

5.1 Installation Procedures



Attention!

Pay close attention to the safety precautions and operating conditions described in Chapter 2. The electrical installation must be performed by experienced and qualified personnel. **A unit only qualifies as a Type 2 protective device according to IEC-, EN 61496-1 if combined with a test monitoring unit.** The test monitoring unit triggers a functional test of ECO transmitter and receiver via the test input of the transmitter, and it checks the switch-off function of the receiver output. If the receiver output does not respond to the test signal within the system response time, the output of the test monitoring unit assumes the „off“ status. (For suitable Leuze electronic test monitoring units or safety interface components, see the connection examples.)

5.2 Power Supply

The power supply to transmitter and receiver must be +24V DC ± 20 %. The maximum power consumption is 150 mA (without load). The power supply must meet the requirements of IEC 60742, exhibiting a safe mains separation as well as being able to bridge short-term mains failures of up to 20 ms.

5.3 Connecting Cables

The devices are connected by means of prepared shielded connecting cables, 5 m long or 15 m long, with angled or straight M12 sockets (see Accessories). The protective screen has to be connected to PE. The cables must be laid separately from power cables. The following tables show the wiring of the transmitter and receiver.

ECO Transmitter		
M12 plug	Wire color	Meaning
1	white	+24V DC*)
2	brown	PE
3	green	0 V*)
4	yellow	test input (0 V = Test)
5	grey	free
6	pink	free
7	blue	free
8	red	protective screen/PE

ECO Receiver		
M12 plug	Wire color	Meaning
1	white	+24V DC*)
2	brown	PE
3	green	0 V*)
4	yellow	OSSD switch output
5	grey	„weak signal“ „error“
6	pink	RS 485+
7	blue	RS 485-
8	red	protective screen/PE

*) To avoid mutual interference by adjacent devices, transmission channel 2 can be chosen by exchanging polarities (white = 0 V, green = +24V DC). The wiring of the transmitter test input (yellow) is not affected.

Fig. 12 ECO Wiring diagram

5.4 Connecting Examples

5.4.1 Test Monitoring with Test Monitoring Unit TNT 35

Up to three pairs of ECO safety light curtains can be connected in series directly to the TNT 35. The safety light curtains receive their power directly from the power supply of the production system/machine. The TNT 35 periodically performs a test monitoring of the light curtains every 2 seconds, without interfering in the production process of the safeguarded machine.

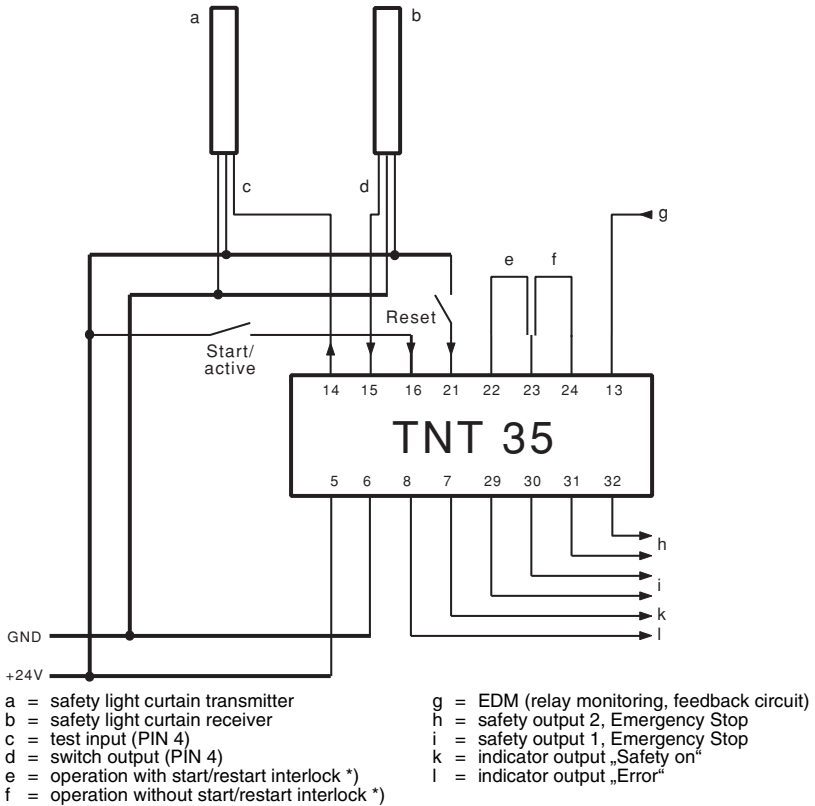

*) Selecting the type of operation through bridge between:
 terminal 22 and 23 (with start/restart interlock) or
 terminal 23 and 24 (without start/restart interlock)

Fig. 13 Test monitoring with TNT 35

5.4.2 Test Monitoring with Modular Safety Interface MSI-s/R

The modular safety interface MSI-s/R performs an automatic functional test of the ECO every 200 ms without impeding the production output of the protected machinery. This

quick succession of cyclical functional tests ensures a maximum of Type 2 functional safety. In addition, it expands the functional range of the ECO, adding „start/restart interlock“ and „protection control“ functions.

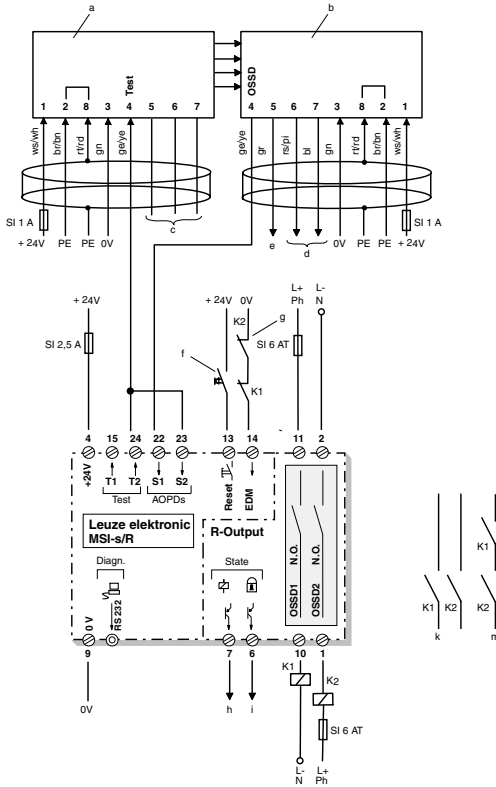

- a = ECO-transmitter
- b = ECO-receiver
- c = not connected
- d = RS-485 interface for diagnosis
- e = pnp-signal output „weak signal/error“
- f = button „reset“
- g = feedback circuit for relay monitoring

- h = indicator output „status safety relay“
- i = indicator output „status restart interlock“
- k = disconnecting path for two-channel control
- m = disconnecting path for single channel control

Fig. 14 Connecting example: ECO with Modular Safety Interface MSI-s/R

5.4.3 Test Monitoring and Muting with Modular Safety Interface MSI-m/R (parallel muting)

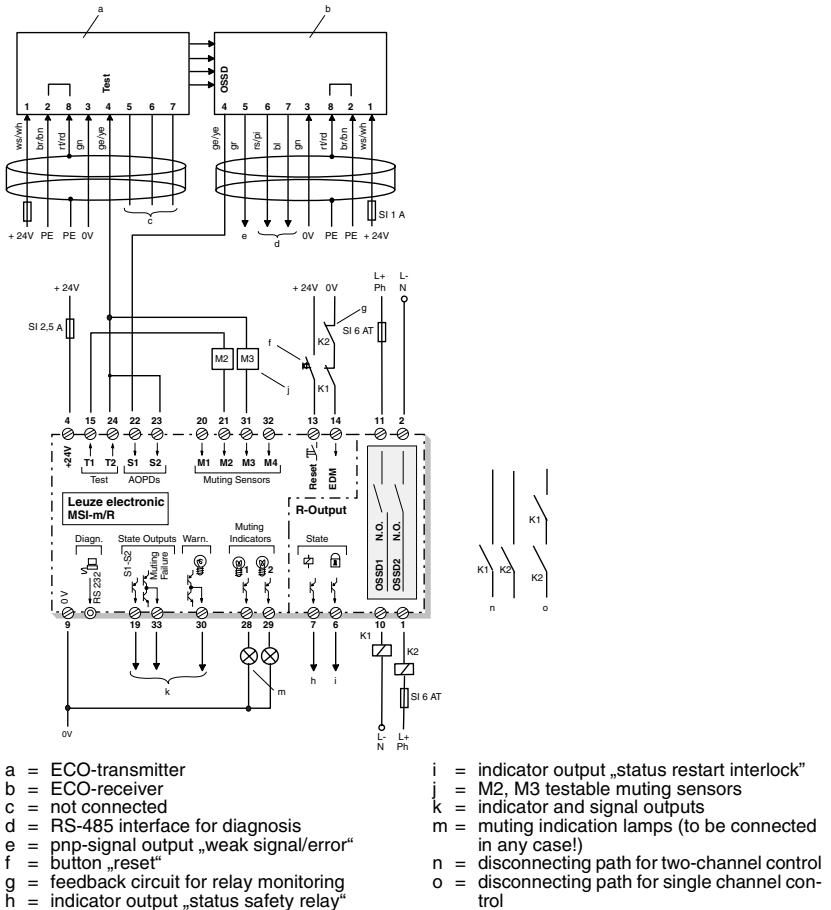

Fig. 15 Connecting example: ECO with Modular Safety Interface MSI-m/R

6 Device Start-up

- Before the unit is switched on for the first time, check the supply voltage (+24V DC $\pm 20\%$).
- Turn on the supply voltage (transmitter „power“ LED on, „test“ LED lights up once briefly).
- A self-test is performed in the transmitter and receiver for approx. 2 seconds.
- In case of optimal adjustment, only the green LED in the receiver will still be illuminated.

If the green LED does not light up after 2 seconds, check the following points:

- Make sure that the system test is not constantly activated (i.e. that the transmitter „test“ LED is not constantly illuminated): If it is, connect the test input according to the connection example → the „test“ LED will go off
- Make sure that there is no object in the sensing zone → if so, remove the object.
- If the „weak signal“ LED (striped arrow) in the receiver is illuminated, check the orientation of the units to each other; transmitter and receiver must be mounted at the same height, and the plexiglass front screens must be exactly parallel to each other. As soon as the orientation is optimal, the „weak signal“ LED will go off.
- If the „failure“ LED lights up in the transmitter or receiver, the corresponding component has an internal defect and must be exchanged.

7 Cleaning

The plexiglass front screens in the transmitter and receiver must be cleaned regularly, depending on the amount of dirt that has accumulated. Illumination of the „weak signal“ LED and the signal output of the receiver indicate, at the latest, when cleaning is necessary. We recommend using a mild cleaning solution for cleaning the plexiglass front screens. They are highly resistant to diluted acids and alkalies, and resistant to organic solvents to a limited extent.

8 Technical Data and Dimensional Drawing

Type in accordance with IEC/EN 61496	Type 2
Category in accordance with EN 954-1	Cat. 2
Service life (T _M)	20 years
Protected heights (Heights of sensing zone)	150 ... 1800 mm for Series E30, E30/ S *) 300 ... 1800 mm for Series E30/M, E55, E55/S *) 450 ... 1800 mm for Series E55/M, E80, E80/M, E80/S*)
Sensing zone width/range	0.3 ... 6 m
Detection capability (Resolution)	Series E30: 30 mm Series E55: 55 mm Series E80: 80 mm
Response time (from the interruption of the sensing zone to the switching off of the OSSD output, without the response time of the test monitoring unit)	Depends on the protected height: Series E30, E30/M, E30/S: 8...29 ms Series E55, E55/M, E55/S: 8...19 ms Series E80, E80/M, E80/S: 8...15 ms For precise response times, see the table page 29
Switch-on time delay (from the release of the sensing zone until the OSSD output is switched on)	From 0.5 ms for all series. In case of very short interruptions of the sensing zone, the OSSD output remains off for at least 100 ms.
Test duration	10 ms
Test input/transmitter	+24V DC = no test, 0 V or high resistance = test via relay (positively driven) make contact or pnp output (signal for triggering test: min. 20 ms)
Enclosure rating	IP 65
Ambient operating temperature	0 ... 55 °C
Protective class	I
Supply voltage	+24V DC ± 20 % (from an external power supply unit with safe mains separation and 20 ms mains failure bridging)
Current consumption	Transmitter: 75 mA Receiver: 75 mA (without load)
OSSD-output	pnp-output, short circuit-proof, 100 mA max
Contamination and error signal	pnp-output, short circuit, 70 mA max

Diagnostic interface/ receiver	RS-485
Electrical connection	8-pin round M12 plug-in connector
Connecting cable	7-pin, 0.25 mm ² , shielded, with injection molded socket, length 5 m or 15 m (see Accessories)
Type of operation	Protective operation without start/restart interlock
Transmitter	Light-emitting diodes as defined by EN 60825-1: 1994 + A1:2002 + A2:2001
Class	1
Wave length	880 nm
Pulse duration	7 ms
Pulse pause	3,12 ms
Output	11,6 μW
Synchronization of transmitter/receiver	Optical synchronization, 2 transmission channels can be selected
Dimensions	Cross section 17 mm x 33 mm Length = protected height + 96 mm
Atmospheric humidity	15 ... 95 % (non condensing)
Storage temperature	-25 ... +75 °C

*) Protected heights of up to 3000 mm available upon request

Measures, weights and response time of ECO safety light curtains

Type	Protecting height = Dim. A [mm]	Dim. B [mm]	Mounting Dim. a [mm]	Weight [kg]	Response time [ms]		
					E30-	E55-	E80-
Exx-150	170.5	248.5	238.5	0.156	7.2		
Exx-225	245.5	323.5	313.5	0.1x98	10.8		
Exx-300	320.5	398.5	388.5	0.240	14.6	7.2	
Exx-450	470.5	548.5	538.5	0.324	10.8	10.8	7.2
Exx-600	620.5	698.5	688.5	0.408	14.4	14.6	9.6
Exx-750	770.5	848.5	838.5	0.492	18	9	12
Exx-900	920.5	998.5	988.5	0.576	14.4	10.8	14.6
Exx-1050	1070.5	1148.5	1138.5	0.660	16.8	12.6	8.4
Exx-1200	1220.5	1298.5	1288.5	0.745	19.2	14.4	9.6
Exx-1350	1370.5	1448.5	1438.5	0.830	21.6	16.2	10.8

Exx-1500	1520.5	1598.5	1588.5	0.913	24	18	12
Exx-1650	1670.5	1748.5	1738.5	0.997	26.4	13.2	13.2
Exx-1800	1820.5	1898.5	1888.5	1.080	28.8	14.4	14.4
Exx-2100	2120.5	2198.5	2188.5	1.200	32.4		16.2
Exx-2400	2420.5	2498.5	2488.5	1.360	38.4	19.2	19.2
Exx-2700	2720.5	2798.5	2788.5	1.520	43.2	21.6	14.4
Exx-3000	3020.5	3098.5	3088.5	1.680	48	24	16

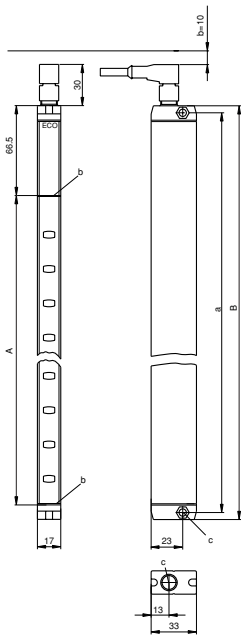

- a = mounting dimension
- b = clearance for removing the plug
- c = screw M4 or M5
- d = end of sensing zone
- e = M12, 8-pin

Fig. 16 Dimensional drawing of ECO Series E30, E55, E80

Dimensional table

Type	Slave Dim. A	Slave Dim. B
Exx-150	180	248.5
Exx-225	255	323.5
Exx-300	330	398.5
Exx-450	480	548.5
Exx-600	630	698.5
Exx-750	780	848.5
Exx-900	930	998.5
Exx-1050	1080	1148.5
Exx-1200	1230	1298.5
Exx-1350	1380	1448.5
Exx-1500	1530	1598.5
Exx-1650	1680	1748.5
Exx-1800	1830	1898.5

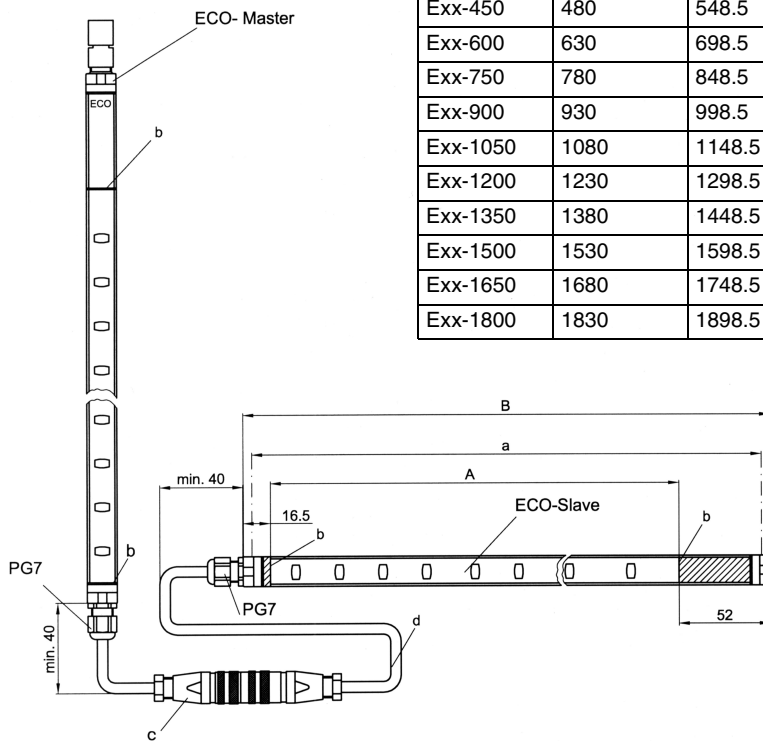

- a = mounting dimension
- b = end of sensing zone
- c = coupling
- d = total length including coupling, max. 250 mm

Fig. 17 Dimensional drawing ECO „Cascaded design“

The response times for master and slave units are made of the sum of the partial response times.

9 Selection and Ordering information

9.1 Selecting an ECO Safety Light Curtain or Light Curtain



1. Consult the relevant regulations for the application in question (e.g. machinery-specific C-Standards in the EU, or OSHA and ANSI standards in the USA). Observe the safety precautions described in Chapter 2.
2. Define the protection aim and select the appropriate ECO series accordingly (e.g. hand protection at a danger point ---> E30; refer to Chapters 1.3 and 2.3) and calculate the safety clearance as shown in Chapter 4.
3. Determine the width of the sensing zone (i.e. the distance between transmitter and receiver). Multi-sided safeguarding can be achieved with the use of deflection mirrors; this decreases the maximum range by approx. 10% per mirror.
4. Determine the protected height (i.e. height of the area to be protected for vertical applications; depth for horizontal applications). Be sure to consider the hazards of reaching over, reaching under, crawling under, etc.
5. Select the suitable device type and locate its order number in the selection table.

9.2 Ordering Information

Device designation:

Example ER30-900 M
Ea bb-dddd e

E ECO
a T = Transmitter
R = Receiver
bb object sensitivity, resolution [mm]
dddd protected height [mm]
e only for cascadable devices
M = Master
S = Slave

Order numbers

Type	E30 (bb = 30)			E55 (bb = 55)			E80 (bb = 80)		
	Standard	Master	Slave	Standard	Master	Slave	Standard	Master	Slave
ETbb-150	621301	—	623301	—	—	—	—	—	—
ERbb-150	624301	—	626301	—	—	—	—	—	—
ETbb-225	621302	—	623302	—	—	—	—	—	—
ERbb-225	624302	—	626302	—	—	—	—	—	—
ETbb-300	621303	622303	623303	621503	—	623503	—	—	—
ERbb-300	624303	625303	626303	624503	—	626503	—	—	—
ETbb-450	621304	622304	623304	621504	622504	623504	621804	622804	623804
ERbb-450	624304	625304	626304	624504	625504	626504	624804	625804	626804

ETbb-600	621306	622306	623306	621506	622506	623506	621806	622806	623806
ERbb-600	624306	625306	626306	624506	625506	626506	624806	625806	626806
ETbb-750	621307	622307	623307	621507	622507	623507	–	–	–
ERbb-750	624307	625307	626307	624507	625507	626507	–	–	–
ETbb-900	621309	622309	623309	621509	622509	623509	621809	622809	623809
ERbb-900	624309	625309	626309	624509	625509	626509	624809	625809	626809
ETbb-1050	621310	622310	623310	621510	622510	623510	–	–	–
ERbb-1050	624310	625310	626310	624510	625510	626510	–	–	–
ETbb-1200	621312	622312	623312	621512	622512	623512	621812	622812	623812
ERbb-1200	624312	625312	626312	624512	625512	626512	624812	625812	626812
ETbb-1350	621313	622313	623313	621513	622513	623513	–	–	–
ERbb-1350	624313	625313	626313	624513	625513	626513	–	–	–
ETbb-1500	621315	622315	623315	621515	622515	623515	621815	622815	623815
ERbb-1500	624315	625315	626315	624515	625515	626515	624815	625815	626815
ETbb-1650	621316	622316	623316	621516	622516	623516	–	–	–
ERbb-1650	624316	625316	626316	624516	625516	626516	–	–	–
ETbb-1800	621318	622318	623318	621518	622518	623518	621818	622818	623818
ERbb-1800	624318	625318	626318	624518	625518	626518	624818	625818	626818

9.3 Scope of Delivery and Accessories

The scope of delivery of an ECO includes:

- 1 ECO transmitter ET...
- 1 ECO Receiver ER ...
- 1 set of instructions for connecting and operating the unit

Accessories: ECO Protective Mounting Profile

The snap-open profile offers additional protection and variable possibilities for mounting using either a standard mounting bracket or a swivelling mounting support.

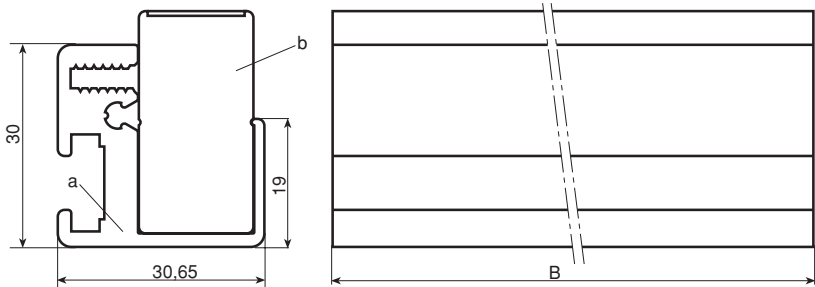

a = ECO protective mounting profile
 b = ECO light curtain

For the dimensions of B, see dimensional table on page 31

Fig. 18 Dimensional drawing ECO protective mounting profile

Order numbers:

Type	Order No.
Connecting cables with M12 socket, 5 m long, straight ³⁾	548405
Connecting cables with M12 socket, 5 m long, angled ³⁾	548305
Connecting cables with M12 socket, 15 m long, straight ³⁾	548415
Connecting cables with M12 socket, 15 m long, angled ³⁾	548315
Protective mounting profile ECO-150	426701
Protective mounting profile ECO-225	426702
Protective mounting profile ECO-300	426703
Protective mounting profile ECO-450	426704
Protective mounting profile ECO-600	426706
Protective mounting profile ECO-750	426707
Protective mounting profile ECO-900	426709
Protective mounting profile ECO-1050	426710
Protective mounting profile ECO-1200	426712
Protective mounting profile ECO-1350	426713
Protective mounting profile ECO-1500	426715
Protective mounting profile ECO-1650	426716
Protective mounting profile ECO-1800	426718
Mounting brackets with accessories (sold in sets of two) ^{1), 2)}	560120
Swivelling mounting with vibration damping ^{1), 2)}	560300

Type	Order No.
Mounting column UDC - 1000 ^{1), 4)}	549810
Mounting column UDC - 1300 ^{1), 4)}	549813
Mounting column UDC - 1600 ^{1), 4)}	549816
Mounting column UDC - 1900 ^{1), 4)}	549819
Deflecting mirror column UMC 1000 ⁴⁾	549710
Deflecting mirror column UMC 1300 ⁴⁾	549713
Deflecting mirror column UMC 1600 ⁴⁾	549716
Deflecting mirror column UMC 1900 ⁴⁾	549719
Test monitoring unit TNT 35	5003305 8
COMPACT/ECO Diagnostic software (runs on Windows 3.1 and higher versions)	560000
RS 485/232 converter for diagnosis interface	520030
RS 232 cable	426500
Set of diagnosis cables (M12 connector straight)	520040
Set of diagnosis cables (M12 connector straight)	520041

- 1) Only for use with the protective mounting profile
- 2) 2 pieces each required for the transmitter and for the receiver
- 3) 2 pieces required (for transmitter and receiver)
- 4) Other heights on request

EG-KONFORMITÄTS- ERKLÄRUNG (AUSZUG)	EC DECLARATION OF CONFORMITY (EXTRACT)	DECLARATION CE DE CONFORMITE (EXTRAIT)
Der Hersteller	The Manufacturer	Le constructeur
erklärt, dass die nachfolgend aufgeführten Produkte den einschlägigen Anforderungen der genannten EG-Richtlinien und Normen entsprechen.	<p>Leuze electronic GmbH + Co. KG In der Braike 1, PO Box 1111 73277 Owen, Germany</p> <p>declares that the following listed products fulfil the relevant provisions of the mentioned EC Directives and standards.</p>	<p>déclare que les produits identifiés suivants sont conformes aux directives CE et normes mentionnées.</p>
Produktbeschreibung:	Description of product:	Description de produit:
Sicherheits- Lichtvorhang ECO	Safety Light Curtain ECO	Barrière immatérielle de sécurité ECO
Angewandte EG-Richtlinie(n):	Applied EC Directive(s):	Directive(s) CE appliquées:
2006/42/EG 2004/108/EG	2006/42/EC 2004/108/EC	2006/42/CE 2004/108/CE
Angewandte Normen:	Applied standards:	Normes appliquées:
DIN EN 60204-1:1997; EN 50178:1998; EN 50178:1998; EN 61496-1:2004 IEC 61496-2:2006; DIN EN 954-1:2007; EN 55022:2006		
Bevollmächtigter für die Zusammenstellung der technischen Unterlagen:	Authorized person to compile the technical file:	Personne autorisée à constituer le dossier technique:
Robert Sammer; Leuze electronic GmbH + Co. KG, business unit safety systems Liebigstr. 4; 82256 Fuerstenfeldbruck; Germany		

Leuze electronic GmbH + Co. KG
 In der Braike 1
 D-73277 Owen
 Telefon +49 (0) 7021 573-0
 Telefax +49 (0) 7021 573-199
 info@leuze.de
 www.leuze.com

LEO-ZQM-149-01-FD

Leuze electronic GmbH + Co. KG, Sitz Owen, Registergericht Stuttgart, HRA 230712
Persönlich haftende Gesellschafterin Leuze electronic Geschäftsführungs-GmbH,
 Sitz Owen, Registergericht Stuttgart, HRB 230550
Geschäftsführer: Dr. Harald Grubel (Vorsitzender), Karsten Just
 USt-IdNr. DE 145912521 | Zollnummer 2554232
 Es gelten ausschließlich unsere aktuellen Verkaufs- und Lieferbedingungen
 Only our current Terms and Conditions of Sale and Delivery shall apply

Nr. 608230-2010/05

You can download the complete EC Declaration of Conformity from the Internet under:
<http://www.leuze.com/eco>