

Technical data sheet

Distance diffuse sensor with background suppression

Part no.: 50155120

ODT53CL1-2M/L6-M8



For illustration purposes only

Contents

- Technical data
- Dimensioned drawings
- Electrical connection
- Diagrams
- Operation and display
- Part number code
- Notes
- Further information
- Accessories



Technical data

Basic data

Series	53C
Operating principle	Distance diffuse sensor with background suppression

Special version

Special version	2 independent switching outputs HYGIENE design Measurement value output
-----------------	---

Optical data

Black-white error	±20 mm
Operating range	0.07 ... 2 m (guaranteed operating range)
Adjustment range	50 ... 2,500 mm
Beam path	Focused
Light source	Laser, Red
Wavelength	680 nm
Laser class	1, IEC 60825-1:2014 / EN 60825-1:2014+A11:2021
Transmitted-signal shape	Pulsed
Light spot size [at sensor distance]	10 mm x 10 mm [100 mm]
Type of light spot geometry	Round
Shift angle	Typ. ± 1.5°

Measurement data

Measurement range	50 ... 2,500 mm
Resolution	1.0 mm
Accuracy	-20 ... 20 mm
Reproducibility (1 sigma)	0 ... 8 mm
Measurement value output	via IO-Link
Optical distance measurement principle	Time of flight

Electrical data

Protective circuit	Polarity reversal protection Short circuit protected Transient protection
--------------------	---

Performance data

Supply voltage U_B	10 ... 30 V, DC, Incl. residual ripple
Residual ripple	0 ... 15 %, From U_B
Open-circuit current	0 ... 35 mA

Outputs

Number of digital switching outputs	2 Piece(s)
-------------------------------------	------------

Switching outputs

Type	Digital switching output
Voltage type	DC
Switching current, max.	90 mA
Switching voltage	high: $\geq(U_B - 2V)$ low: $\leq 2 V$

Switching output 1

Assignment	Connection 1, pin 4
Switching element	Transistor, Push-pull
Switching principle	IO-Link / light switching (PNP)/dark switching (NPN)

Switching output 2

Assignment	Connection 1, pin 2
Switching element	Transistor, Push-pull
Switching principle	Light switching (PNP)/dark switching (NPN)

Time behavior

Switching frequency	7 ... 15 Hz, depending on diffuse reflectance
Response time	33 ... 70 ms, depending on diffuse reflectance
Readiness delay	300 ms

Interface

Type	IO-Link
IO-Link	
COM mode	COM3
Profile	Smart sensor profile
Min. cycle time	COM3 = 0.6 ms
Frame type	2.V
Specification	V1.1
Device ID	2226
SIO-mode support	Yes

Connection

Number of connections	1 Piece(s)
Connection 1	
Function	Signal IN Signal OUT Voltage supply
Type of connection	Connector
Thread size	M8
Type	Male
Material	Stainless steel
No. of pins	4 -pin

Mechanical data

Dimension (W x H x L)	14 mm x 35.4 mm x 20.4 mm
Housing material	Stainless steel
Stainless steel housing	AISI 316L, DIN X2CrNiMo17132, W. No1.4404
Housing roughness	Ra ≤ 0,8, Typical value for the stainless steel housing
Lens cover material	Plastic (PMMA+) with scratch-resistant Indium protective coating
Net weight	48 g
Housing color	Silver
Type of fastening	Housing fit
Compatibility of materials	CleanProof+ ECOLAB Johnson Diversey

Operation and display

Type of display	LED
Number of LEDs	2 Piece(s)

Environmental data

Ambient temperature, operation	-30 ... 50 °C
Ambient temperature, storage	-40 ... 70 °C

Technical data

Certifications

Degree of protection	IP 67
	IP 68
	IP 69K
Protection class	III
Approvals	c UL US
Standards applied	IEC 60947-5-2

Classification

Customs tariff number	85365019
ECLASS 5.1.4	27270904
ECLASS 8.0	27270904
ECLASS 9.0	27270904
ECLASS 10.0	27270904
ECLASS 11.0	27270904
ECLASS 12.0	27270903
ECLASS 13.0	27270903
ECLASS 14.0	27270903
ECLASS 15.0	27270903
ECLASS 16.0	27270903
ETIM 5.0	EC002719
ETIM 6.0	EC002719
ETIM 7.0	EC002719
ETIM 8.0	EC002719
ETIM 9.0	EC002719
ETIM 10.0	EC002719

Dimensioned drawings

All dimensions in millimeters

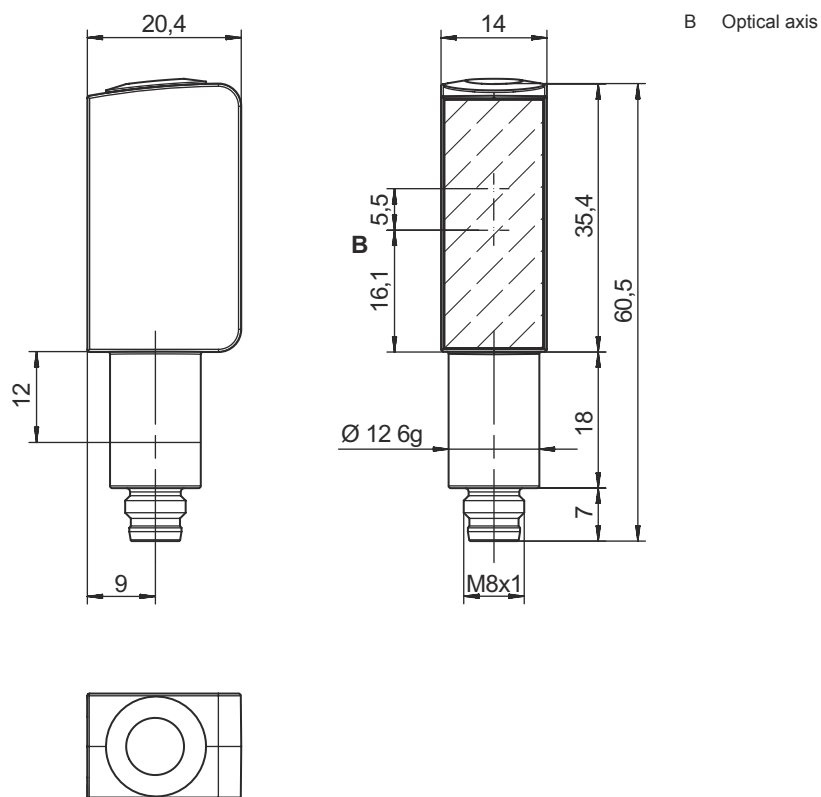

Electrical connection

Connection 1

Function	Signal IN Signal OUT Voltage supply
Type of connection	Connector
Thread size	M8
Type	Male
Material	Stainless steel
No. of pins	4 -pin

Pin	Pin assignment
1	V+
2	OUT 2
3	GND
4	IO-Link / OUT 1

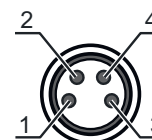

Diagrams

Typ. response behavior (white 90 %)

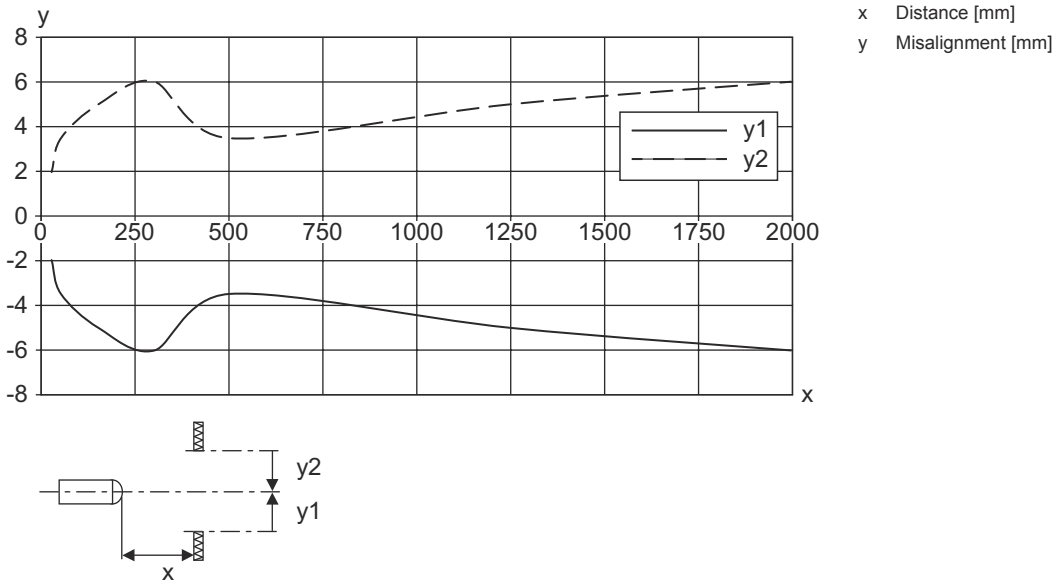

Typical reproducibility (1 Sigma / 25°C)

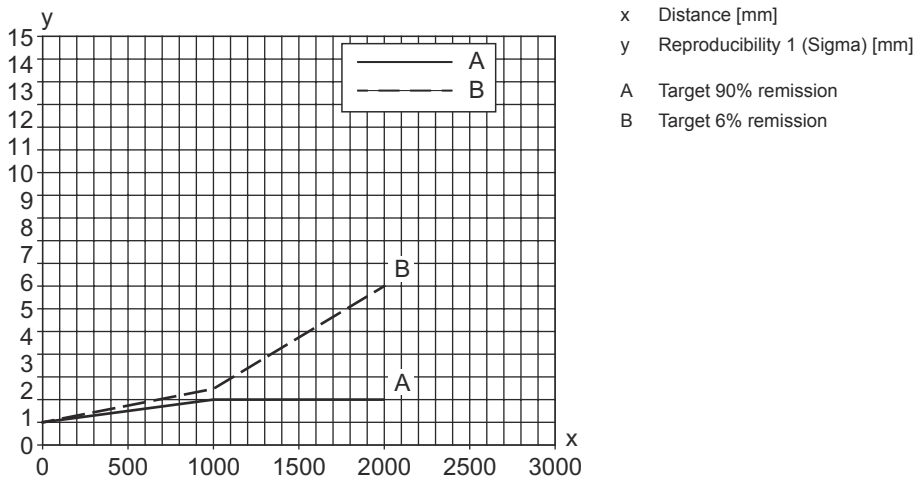

S/W behavioral diagram

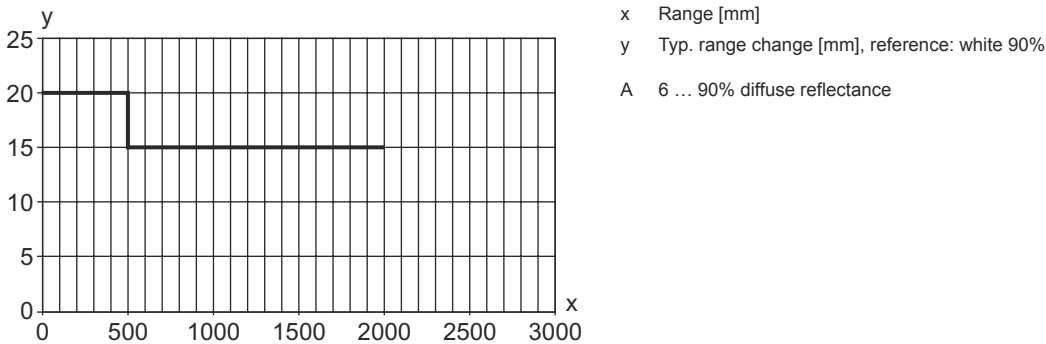

Operation and display

LED	Display	Meaning
1	Green, continuous light	Operational readiness
2	Yellow, continuous light	Object detected

Part number code

Part designation: **AAA53C d EE-f.GGGG H/i J-K.LL**

AAA53C	Operating principle / construction HT53C: Diffuse reflection sensor with background suppression LS53C: Throughbeam photoelectric sensor transmitter LE53C: Throughbeam photoelectric sensor receiver PRK53C: Retro-reflective photoelectric sensor with polarization filter ODT53C: Distance diffuse sensor with background suppression
d	Light type n/a: red light I: infrared light
EE	Light source n/a: LED L1: laser class 1 L2: laser class 2
f	Preset range (optional) n/a: operating range acc. to data sheet xxxF: Preset range [mm] 2M: operating range of 2 meters
GGGG	Equipment n/a: standard A: Autocollimation principle (single lens) for positioning tasks F: Permanently set range H2O: Detection of aqueous liquids Fill-level monitoring S: small light spot T: autocollimation principle (single lens) for highly transparent bottles without tracking TT: autocollimation principle (single lens) for highly transparent bottles with tracking V: V-optics XL: Extra long light spot X: extended model
H	Operating range adjustment n/a with HT: range adjustable via 8-turn potentiometer n/a with retro-reflective photoelectric sensors (PRK): operating range not adjustable 1: 270° potentiometer 3: teach-in via button
i	Switching output/function OUT 1/IN: Pin 4 or black conductor 2: NPN transistor output, light switching N: NPN transistor output, dark switching 4: PNP transistor output, light switching P: PNP transistor output, dark switching 6: push-pull switching output, PNP light switching, NPN dark switching G: Push-pull switching output, PNP dark switching, NPN light switching L: IO-Link interface (SIO mode: PNP light switching, NPN dark switching) 8: activation input (activation with high signal) X: pin not used 1: IO-Link / light switching (NPN) / dark switching (PNP) 7: Input for sensitivity adjustment

Part number code

J	Switching output / function OUT 2/IN: pin 2 or white conductor 2: NPN transistor output, light switching N: NPN transistor output, dark switching 4: PNP transistor output, light switching P: PNP transistor output, dark switching 6: push-pull switching output, PNP light switching, NPN dark switching G: Push-pull switching output, PNP dark switching, NPN light switching T: teach-in via cable X: pin not used 8: activation input (activation with high signal) 9: deactivation input (deactivation with high signal)
K	Electrical connection M8: M8 connector, 4-pin (plug)
LL	Parameterization P1: different configuration

Note



A list with all available device types can be found on the Leuze website at www.leuze.com.

Notes



Observe intended use!



- ⚡ This product is not a safety sensor and is not intended as personnel protection.
- ⚡ The product may only be put into operation by competent persons.
- ⚡ Only use the product in accordance with its intended use.

For UL applications:



- ⚡ For UL applications, use is only permitted in Class 2 circuits in accordance with the NEC (National Electric Code).
- ⚡ These proximity switches shall be used with UL Listed Cable assemblies rated 30V, 0.5A min, in the field installation, or equivalent (categories: CYJV/ CYJV7 or PVVA/PVVA7)



ATTENTION! LASER RADIATION – CLASS 1 LASER PRODUCT



- The device satisfies the requirements of IEC 60825-1:2014 / EN 60825-1:2014+A11:2021 safety regulations for a product of **laser class 1** and complies with 21 CFR 1040.10 except for conformance with IEC 60825-1 Ed. 3., as described in Laser Notice No. 56, dated May 8, 2019.
- ⚡ Observe the applicable statutory and local laser protection regulations.
 - ⚡ The device must not be tampered with and must not be changed in any way.
There are no user-serviceable parts inside the device.
CAUTION! Opening the device can result in dangerous radiation exposure!
Repairs must only be performed by Leuze electronic GmbH + Co. KG.

Further information



- Sum of the output currents for both outputs, 50 mA for ambient temperatures > 40 °C
- With a supply voltage >18 V and an ambient temperature <40 °C, the maximum switching current is 100 mA per switching output.
- When starting the sensor below -20°C, a warmup time of one minute is required until the first teach-in
- IP 69K only with internal tube installation of M8 connector

Accessories

Connection technology - Connection unit

	Part no.	Designation	Article	Description
	50144900	MD 798i-11-82/L5-2222	IO-Link master	Current consumption, max.: 11,000 mA Interface: IO-Link, Automatic protocol detection, EtherNet IP, Modbus TCP, PROFINET Connections: 12 Piece(s) Sensor connections: 8 Piece(s) Degree of protection: IP 67, IP 65, IP 69K

Connection technology - Connection cables

	Part no.	Designation	Article	Description
	50148347	KD U-M8-4A-T0-050 F+B	Connection cable	Application: Chemical resistant, Hygienic and wet areas Connection 1: Connector, M8, Axial, Female, A-coded, 4 -pin Connector, LED: No Connection 2: Open end Shielded: No Cable length: 5,000 mm Sheathing material: TPE
	50130850	KD U-M8-4A-V1-050	Connection cable	Application: Chemical resistant Connection 1: Connector, M8, Axial, Female, 4 -pin Connector, LED: No Connection 2: Open end Shielded: No Cable length: 5,000 mm Sheathing material: PVC
	50130871	KD U-M8-4W-V1-050	Connection cable	Application: Chemical resistant Connection 1: Connector, M8, Angled, Female, 4 -pin Connector, LED: No Connection 2: Open end Shielded: No Cable length: 5,000 mm Sheathing material: PVC

Mounting technology - Other

	Part no.	Designation	Article	Description
	50145361	BTU 053M.5F-D12-T	Mounting system	Design of mounting device: Mounting system Fastening, at system: Screw type Mounting bracket, at device: For 12 mm rod Type of mounting device: Turning, 360°, Adjustable Material: Stainless steel

Accessories

Note



🔗 A list with all available accessories can be found on the Leuze website in the Download tab of the article detailed page.