

Technical data sheet

Polarized retro-reflective photoelectric sensor

Part no.: 50134369

PRK15/2X-200-M12



For illustration purposes only

Contents

- Technical data
- Dimensioned drawings
- Electrical connection
- Diagrams
- Operation and display
- Reflectors & reflective tapes
- Part number code
- Notes
- Further information
- Accessories



Technical data

Basic data

| | |
|---------------------|----------------------|
| Series | 15 |
| Operating principle | Reflection principle |

Optical data

| | |
|--------------------------|---|
| Operating range | 0.05 ... 8 m (guaranteed operating range), With reflector TK(S) 100x100 |
| Operating range limit | 0.05 ... 10 m (typical operating range), With reflector TK(S) 100x100 |
| Light source | LED, Red |
| Wavelength | 640 nm |
| Transmitted-signal shape | Pulsed |
| LED group | Exempt group (in acc. with EN 62471) |

Electrical data

| | |
|--------------------|------------------------------|
| Protective circuit | Polarity reversal protection |
| | Short circuit protected |

Performance data

| | |
|----------------------|--|
| Supply voltage U_B | 10 ... 30 V, DC, Incl. residual ripple |
| Residual ripple | 0 ... 15 %, From U_B |
| Open-circuit current | 0 ... 20 mA |

Outputs

| | |
|-------------------------------------|------------|
| Number of digital switching outputs | 1 Piece(s) |
|-------------------------------------|------------|

Switching outputs

| | |
|-------------------------|--------------------------|
| Type | Digital switching output |
| Voltage type | DC |
| Switching current, max. | 100 mA |
| Switching voltage | high: $\geq(U_B - 2.5V)$ |
| | low: $\leq 2.5 V$ |

Switching output 1

| | |
|---------------------|---------------------|
| Assignment | Connection 1, pin 4 |
| Switching element | Transistor, NPN |
| Switching principle | Light switching |

Time behavior

| | |
|---------------------|--------|
| Switching frequency | 500 Hz |
| Response time | 1 ms |
| Readiness delay | 300 ms |

Connection

| | |
|-----------------------|------------|
| Number of connections | 1 Piece(s) |
|-----------------------|------------|

Connection 1

| | |
|--------------------|----------------------|
| Function | Signal OUT |
| | Voltage supply |
| Type of connection | Cable with connector |
| Cable length | 200 mm |
| Sheathing material | PUR |
| Cable color | Black |
| Wire cross section | 0.14 mm ² |
| Thread size | M12 |
| Type | Male |
| Material | Plastic |
| No. of pins | 4 -pin |
| Encoding | A-coded |

Mechanical data

| | |
|--|------------------------------|
| Dimension (W x H x L) | 15 mm x 42.7 mm x 30 mm |
| Housing material | Plastic |
| Plastic housing | ABS |
| Lens cover material | Plastic |
| Net weight | 22 g |
| Housing color | Black |
| Type of fastening | Through-hole mounting |
| | Via optional mounting device |
| Recommended tightening torque for M3 fastening | 0.9 N·m |
| Recommended tightening torque for M4 fastening | 1.4 N·m |

Operation and display

| | |
|-----------------|------------|
| Type of display | LED |
| Number of LEDs | 2 Piece(s) |

Environmental data

| | |
|--------------------------------|---------------|
| Ambient temperature, operation | -40 ... 60 °C |
| Ambient temperature, storage | -40 ... 70 °C |

Certifications

| | |
|----------------------|---------------|
| Degree of protection | IP 67 |
| Protection class | III |
| Approvals | c UL US |
| Standards applied | IEC 60947-5-2 |

Classification

| | |
|-----------------------|----------|
| Customs tariff number | 85365019 |
| ECLASS 5.1.4 | 27270902 |
| ECLASS 8.0 | 27270902 |
| ECLASS 9.0 | 27270902 |
| ECLASS 10.0 | 27270902 |
| ECLASS 11.0 | 27270902 |
| ECLASS 12.0 | 27270902 |
| ECLASS 13.0 | 27270902 |
| ECLASS 14.0 | 27270902 |
| ECLASS 15.0 | 27270902 |
| ETIM 5.0 | EC002717 |
| ETIM 6.0 | EC002717 |
| ETIM 7.0 | EC002717 |
| ETIM 8.0 | EC002717 |
| ETIM 9.0 | EC002717 |
| ETIM 10.0 | EC002717 |

Dimensioned drawings

All dimensions in millimeters

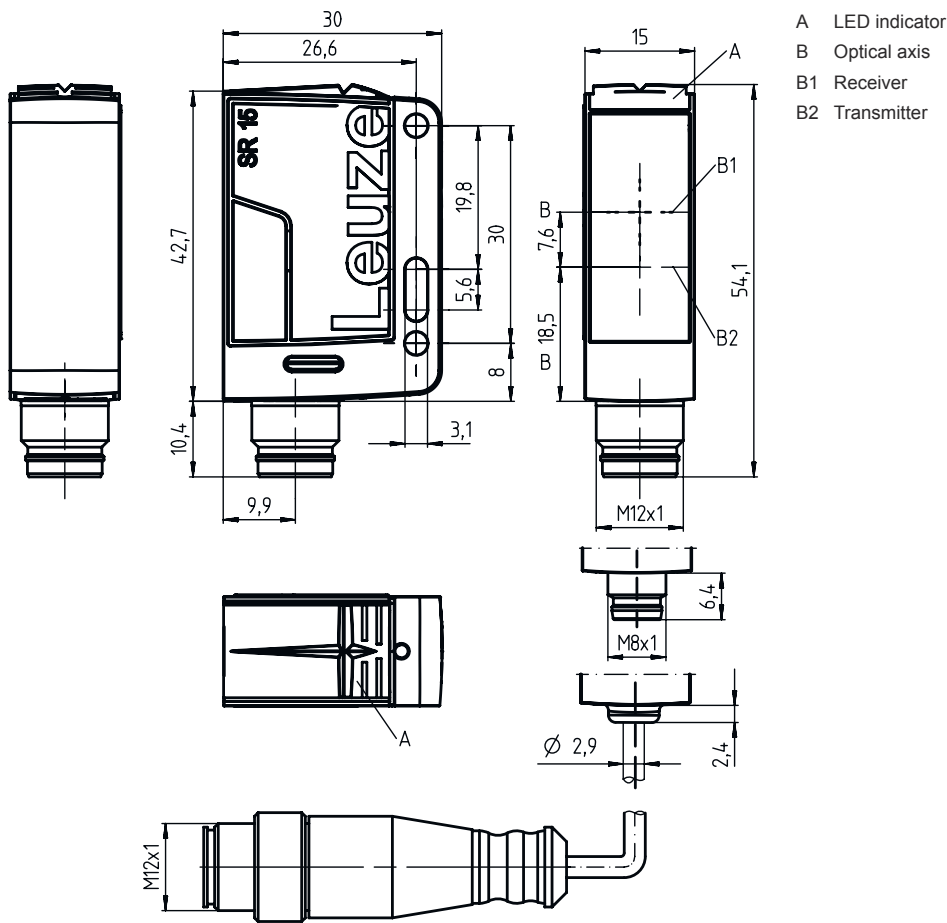

- A LED indicator
- B Optical axis
- B1 Receiver
- B2 Transmitter

Electrical connection

Connection 1

| | |
|--------------------|------------------------------|
| Function | Signal OUT Voltage supply |
| Type of connection | Cable with connector |
| Cable length | 200 mm |
| Sheathing material | PUR |
| Cable color | Black |
| Wire cross section | 0.14 mm ² |
| Thread size | M12 |
| Type | Male |
| Material | Plastic |
| No. of pins | 4 -pin |
| Encoding | A-coded |

Pin Pin assignment

| | |
|---|-------|
| 1 | V+ |
| 2 | n.c. |
| 3 | GND |
| 4 | OUT 1 |

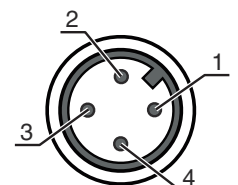

Diagrams

Typ. function reserve

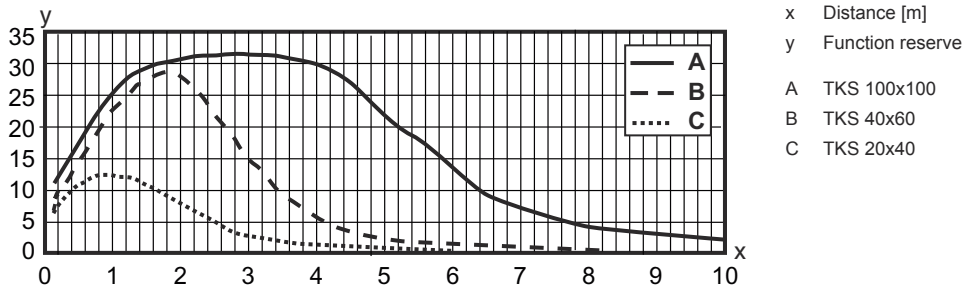

Typ. response behavior (TKS100x100)

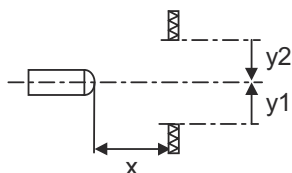
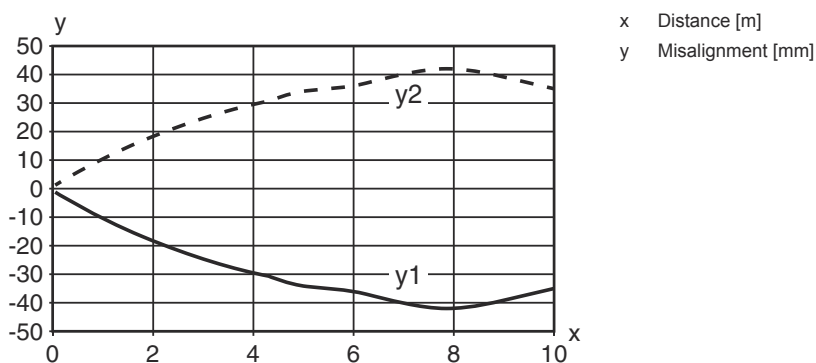

Operation and display

| LED | Display | Meaning |
|-----|--------------------------|--------------------------------------|
| 1 | Green, continuous light | Operational readiness |
| 2 | Yellow, continuous light | Light path free |
| | Yellow, flashing | Light path free, no function reserve |

Reflectors & reflective tapes

| Part no. | Designation | Operating range Operating range limit | Description |
|----------|--------------|--|--|
| 50117583 | MTKS 50x50.1 | 0.05 ... 5 m 0.05 ... 6 m | Design: Rectangular Triple reflector size: 1.2 mm Reflective surface: 50 mm x 50 mm Material: Plastic Base material: Plastic Chemical designation of the material: PMMA8N Fastening: Through-hole mounting, Adhesive |



Reflectors & reflective tapes

| | Part no. | Designation | Operating range Operating range limit | Description |
|---|----------|---------------|---|--|
|  | 50110192 | REF 6-A-50x50 | 0.08 ... 3.5 m 0.05 ... 4 m | Design: Rectangular Triple reflector size: 0.3 mm Reflective surface: 50 mm x 50 mm Material: Plastic Chemical designation of the material: PMMA Fastening: Self-adhesive |
|  | 50003192 | TK 100x100 | 0.05 ... 8 m 0.05 ... 10 m | Design: Rectangular Triple reflector size: 4 mm Reflective surface: 96 mm x 96 mm Material: Plastic Base material: Plastic Chemical designation of the material: PMMA8N Fastening: Rear side can be glued |
|  | 50022816 | TKS 100X100 | 0.05 ... 8 m 0.05 ... 10 m | Design: Rectangular Triple reflector size: 4 mm Reflective surface: 96 mm x 96 mm Material: Plastic Base material: Plastic Chemical designation of the material: PMMA8N Fastening: Through-hole mounting, Adhesive |
|  | 50081283 | TKS 20X40 | 0.05 ... 2.5 m 0.05 ... 3 m | Design: Rectangular Triple reflector size: 2.3 mm Reflective surface: 16 mm x 38 mm Material: Plastic Base material: Plastic Chemical designation of the material: PMMA8N Fastening: Through-hole mounting, Adhesive |
|  | 50040820 | TKS 40X60 | 0.05 ... 4 m 0.05 ... 5 m | Design: Rectangular Triple reflector size: 4 mm Reflective surface: 37 mm x 56 mm Material: Plastic Base material: Plastic Chemical designation of the material: PMMA8N Fastening: Through-hole mounting, Adhesive |

Part number code

Part designation: AAA15d.EE/ ff-HH

| | |
|--------------|--|
| AAA15 | Operating principle / construction HT15: diffuse reflection sensor with background suppression PRK15: retro-reflective photoelectric sensor with polarization filter LS15: throughbeam photoelectric sensor transmitter LE15: throughbeam photoelectric sensor receiver |
| d | Light type n/a: red light I: infrared light |
| EE | Equipment 1: adjustable range D: Detection of stretch-wrapped objects |
| ff | Switching output / Function 2: NPN transistor output, light switching N: NPN transistor output, dark switching 4: PNP transistor output, light switching P: PNP transistor output, dark switching X: pin not used |

Part number code

| | |
|----|--|
| HH | Electrical connection n/a: cable, standard length 2000 mm, 3-wire M8: M8 connector, 4-pin (plug) 200-M12: cable, length 200 mm with M12 connector, 4-pin, axial (plug) M12: M12 connector, 4-pin (plug) |
|----|--|

Note



A list with all available device types can be found on the Leuze website at www.leuze.com.

Notes

Observe intended use!



- ⌘ This product is not a safety sensor and is not intended as personnel protection.
- ⌘ The product may only be put into operation by competent persons.
- ⌘ Only use the product in accordance with its intended use.

Further information

- Light source: Average life expectancy 100,000h at an ambient temperature of 25 °C

Accessories

Connection technology - Connection cables



| | Part no. | Designation | Article | Description |
|--|----------|--------------------|------------------|--|
| | 50130652 | KD U-M12-4A-V1-050 | Connection cable | Connection 1: Connector, M12, Axial, Female, A-coded, 4 -pin Connector, LED: No Connection 2: Open end Shielded: No Cable length: 5.000 mm Sheathing material: PVC |
| | 50130690 | KD U-M12-4W-V1-050 | Connection cable | Connection 1: Connector, M12, Angled, Female, A-coded, 4 -pin Connector, LED: No Connection 2: Open end Shielded: No Cable length: 5.000 mm Sheathing material: PVC |

Accessories

Mounting technology - Mounting brackets

| | Part no. | Designation | Article | Description |
|---|----------|-------------|-----------------|--|
|  | 50040269 | BT 25 | Mounting device | Design of mounting device: Angle, L-shape Fastening, at system: Through-hole mounting Mounting bracket, at device: Screw type Type of mounting device: Rigid Material: Metal |

Mounting technology - Rod mounts

| | Part no. | Designation | Article | Description |
|--|----------|--------------|-----------------|--|
|  | 50117829 | BTP 200M-D12 | Mounting system | Design of mounting device: Protection hood Fastening, at system: For 12 mm rod Mounting bracket, at device: Screw type Type of mounting device: Clampable, Adjustable, Turning, 360° Material: Metal |
|  | 50117255 | BTU 200M-D12 | Mounting system | Design of mounting device: Mounting system Fastening, at system: For 12 mm rod, Sheet-metal mounting Mounting bracket, at device: Screw type, Suited for M3 screws Type of mounting device: Clampable, Adjustable, Turning, 360° Material: Metal |

Note



A list with all available accessories can be found on the Leuze website in the Download tab of the article detailed page.