

Technical data sheet

Safety light curtain receiver

Part no.: 68021403
MLC520R40-300G



Contents

- Technical data
- Dimensioned drawings
- Electrical connection
- Suitable transmitters
- Part number code
- Notes
- Accessories



Technical data

Basic data

Series	MLC 500
Device type	Receiver
Cascading	Guest
Contains	2x BT-NC sliding block
Application	Access guarding Danger zone guarding Hand protection

Characteristic parameters

Type	4, IEC/EN IEC 61496
SIL	3, IEC 61508
SIL	3, IEC/EN IEC 62061
Performance Level (PL)	e, EN ISO 13849-1
Mission time T _M	20 years, EN ISO 13849-1
Category	4, EN ISO 13849

Protective field data

Resolution	40 mm
Protective field height	300 mm

Optical data

Number of beams	12 Piece(s)
-----------------	-------------

Time behavior

Response time	3 ms, plus response times of the Host/ Middle Guest devices
---------------	--

Connection

Number of connections	1 Piece(s)
-----------------------	------------

Connection 1

Function	Cascade, Host In Cascade, Middle Guest In
Type of connection	Cable with connector
Cable length	330 mm
Sheathing material	PUR
Thread size	M12
Material	Plastic
No. of pins	8 -pin

Mechanical data

Dimension (W x H x L)	29 mm x 314 mm x 53 mm
Housing material	Metal
Metal housing	Aluminum
Lens cover material	Plastic / PMMA
Material of end caps	Diecast zinc
Net weight	423 g
Housing color	Yellow, RAL 1021
Type of fastening	Groove mounting Mounting brackets Swivel mount

Environmental data

Ambient temperature, operation	0 ... 55 °C
Ambient temperature, storage	-30 ... 70 °C
Relative humidity (non-condensing)	0 ... 95 %

Certifications

Degree of protection	IP 65
Protection class	III
Approvals	c TÜV NRTL US c UL US TÜV Süd
Vibration resistance	50 m/s ²
Shock resistance	100 m/s ²
US patents	US 6,418,546 B

Classification

Customs tariff number	85365019
ECLASS 5.1.4	27272704
ECLASS 8.0	27272704
ECLASS 9.0	27272704
ECLASS 10.0	27272704
ECLASS 11.0	27272704
ECLASS 12.0	27272704
ECLASS 13.0	27272704
ECLASS 14.0	27272704
ECLASS 15.0	27272704
ECLASS 16.0	27272704
ETIM 5.0	EC002549
ETIM 6.0	EC002549
ETIM 7.0	EC002549
ETIM 8.0	EC002549
ETIM 9.0	EC002549
ETIM 10.0	EC002549
UNSPSC 26.08	46171620

Dimensioned drawings

All dimensions in millimeters

Calculation of the effective protective field height $H_{PFE} = H_{PFN} + B + C$

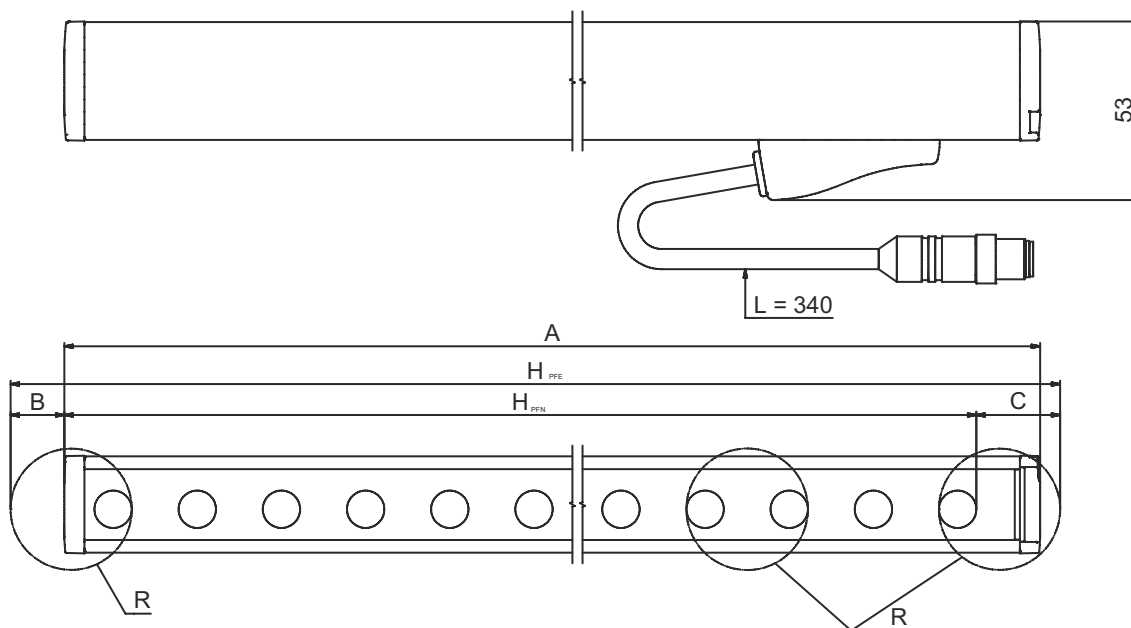

H_{PFE} Effective protective field height = 340 mm

H_{PFN} Nominal protective field height = 300 mm

A Total height = 314 mm

B 25 mm

C 15 mm

R Effective protective field height H_{PFE} goes beyond the dimensions of the optics area to the outer borders of the circles labeled with R.

Electrical connection

Connection 1

Function	Cascade, Host In
	Cascade, Middle Guest In
Type of connection	Cable with connector
Cable length	330 mm
Sheathing material	PUR
Cable color	Black
Type of stranding	Pair stranding (twisted pair)
Wire cross section	0.14 mm ²
Thread size	M12
Type	Male
Material	Plastic
No. of pins	8 -pin
Encoding	A-coded

Suitable transmitters

	Part no.	Designation	Article	Description
	68020403	MLC500T40-300G	Safety light curtain transmitter	Resolution: 40 mm Protective field height: 300 mm Operating range: 0 ... 20 m Connection: Cable with connector, M12, Plastic, 8 -pin, 330 mm, PUR

Part number code

Part designation: MLCxyy-za-hhhhei-ooo

MLC	Safety light curtain
x	Series 3: MLC 300 5: MLC 500
yy	Function classes 00: transmitter 01: transmitter (AIDA) 02: transmitter with test input 10: basic receiver - automatic restart 11: basic receiver - automatic restart (AIDA) 20: standard receiver - EDM/RES selectable 30: Extended receiver blanking/muting or gating 35: Extended receiver – Gating
z	Device type T: transmitter R: receiver
a	Resolution 14: 14 mm 20: 20 mm 30: 30 mm 40: 40 mm 90: 90 mm
hhhh	Protective field height 150 ... 3000: from 150 mm to 3000 mm
e	Host/Guest (optional) H: Host MG: Middle Guest G: Guest
i	Interface (optional) /A: AS-i
ooo	Option /V: high Vibration-proof EX2: explosion protection (zones 2 + 22) SPG: Smart Process Gating SPG RR: Smart Process Gating – Reduced resolution

Note



A list with all available device types can be found on the Leuze website at www.leuze.com.

Notes

 **Observe intended use!**



- The product may only be put into operation by competent persons.
- Only use the product in accordance with its intended use.

Accessories

Connection technology - Interconnection cables

	Part no.	Designation	Article	Description
	429278	CB-M12-2000E-8TP	Interconnection cable	Application: Oil and lubricant resistant Connection 1: Connector, M12, Axial, Female, A-coded, 8 -pin Connection 2: Connector, M12, Axial, Male, A-coded, 8 -pin Shielded: Yes Cable length: 2,000 mm Sheathing material: PUR

Mounting technology - Mounting brackets

	Part no.	Designation	Article	Description
	429006	BT-2L-HG	Mounting device set	Mounting bracket, at device: Screw type Material: Metal

Mounting technology - Swivel mounts

	Part no.	Designation	Article	Description
	429395	BT-2HF-G	Mounting bracket set	Contains: 2x BT-HF swivel mount, 2 cylinders for mounting on the light curtain Fastening, at system: Through-hole mounting Mounting bracket, at device: Clampable Type of mounting device: Turning, 360° Material: Metal, Plastic

Services

	Part no.	Designation	Article	Description
	S981050	CS40-I-140	Safety inspection	Details: Checking of a safety light barrier application in accordance with current standards and guidelines. Inclusion of the device and machine data in a database, production of a test log per application. Conditions: It must be possible to stop the machine, support provided by customer's employees and access to the machine for Leuze employees must be ensured.
	S981046	CS40-S-140	Start-up support	Details: For safety devices including stopping time measurement and initial inspection. Conditions: Devices and connection cables are already mounted, price not including travel costs and, if applicable, accommodation expenses.

Note



A list with all available accessories can be found on the Leuze website in the Download tab of the article detailed page.