

Technical data sheet

Device column

Part no.: 549883

UDC-1600-S2-R

Contents

- Technical data
- Dimensioned drawings
- Accessories



For illustration purposes only

Technical data

Basic data

Series	UDC
Contains	BT-P40 clamp bracket, 2x
	Mounting kit for floor assembly
Suitable for	CML700i light curtains
	CSL 710 light curtains
Type, columns and mirrors	Device column

Functions

Functions	Adjustable, 3 directions
	Mounting and protection of light curtains and multiple light beam devices

Mechanical data

Dimension (W x H x L)	160 mm x 1,660 mm x 149 mm
Housing material	Metal
	Plastic
Metal housing	Aluminum
Net weight	6,075 g
Housing color	Red, RAL 3000
Type of fastening	Floor mounting
	Mounting plate
Mechanical reset function	Yes
Column height without foot	1,600 mm
Exterior mounting of accessories	Lateral
	Rear

Classification

Customs tariff number	76042990
ECLASS 5.1.4	27279290
ECLASS 8.0	27279290
ECLASS 9.0	27279090
ECLASS 10.0	27273792
ECLASS 11.0	27273792
ECLASS 12.0	27273792
ETIM 5.0	EC002498
ETIM 6.0	EC003015
ETIM 7.0	EC003015
ETIM 8.0	EC003015

Dimensioned drawings

All dimensions in millimeters

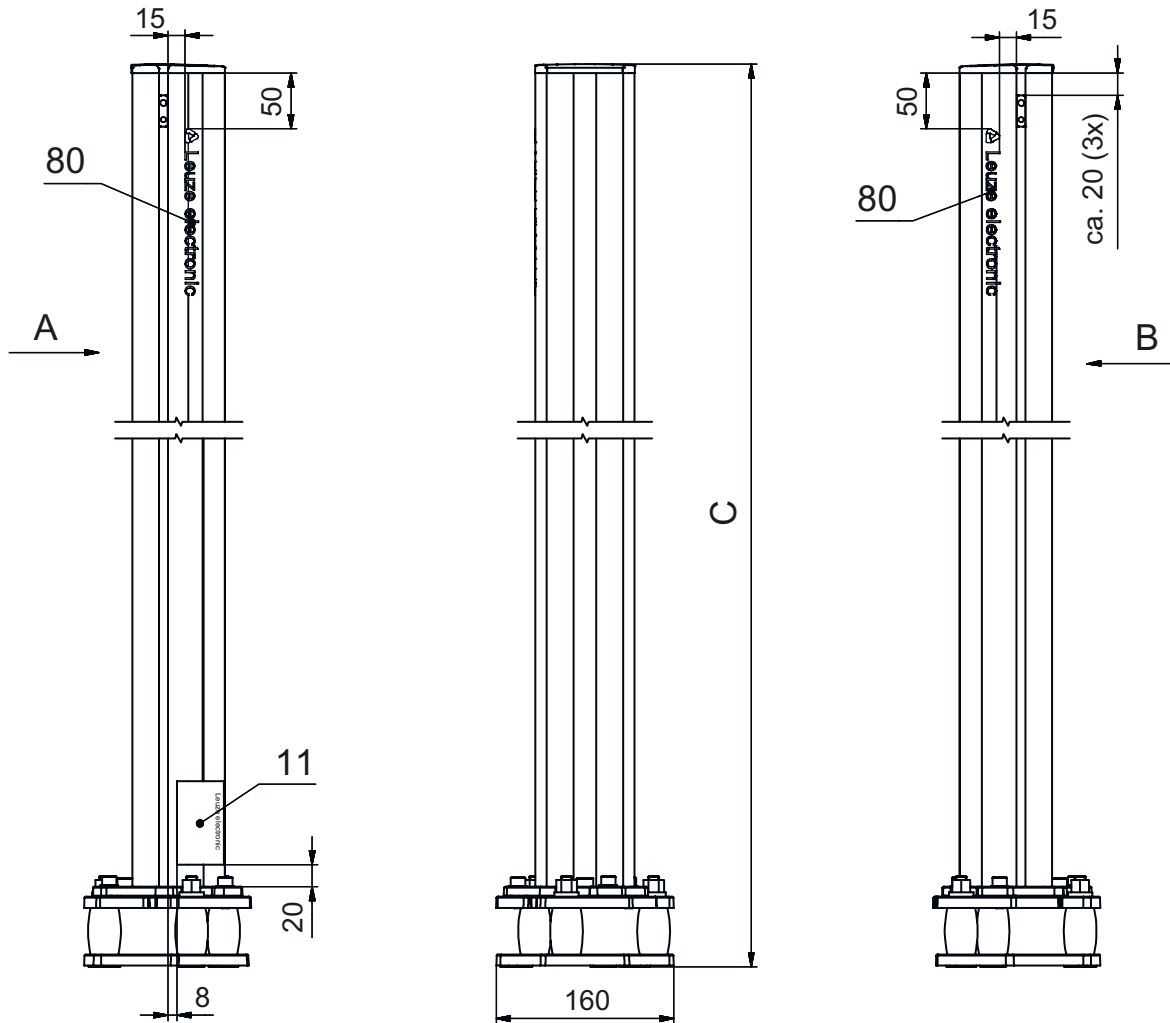

- A Front
- B Front
- C Total height = 1660 mm

Dimensioned drawings

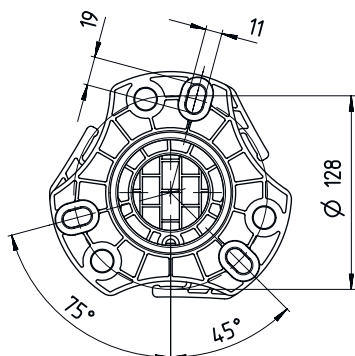

L Column height without foot = 1600 mm

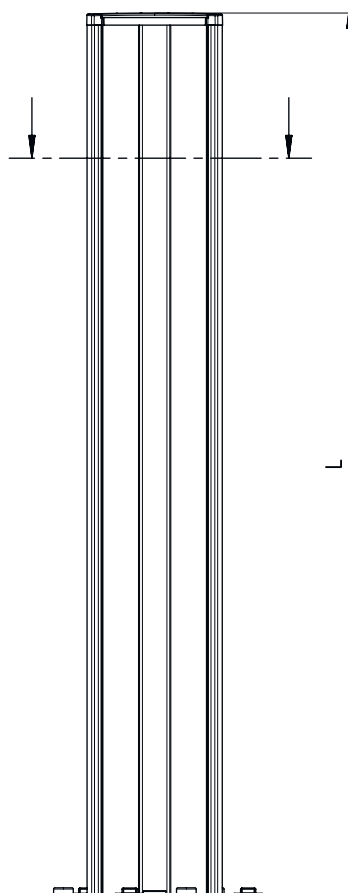

Accessories

Muting - Mounting systems

Part no.	Designation	Article	Description
50144378	SET 10x AC-UDC-2000	Profile	Contains: 10x Suitable for: UDC-S2, DC-S2 device columns Length: 2,000 mm Material: PVC

Accessories

Replacement part

	Part no.	Designation	Article	Description
	430220	SP-SET AP UDC/DC/ UMC/MC	Device and mirror column accessory set	Type of article: Adapter plate Dimensions: 17.5 mm Housing color: Black

Note



A list with all available accessories can be found on the Leuze website in the Download tab of the article detailed page.