

## Technical data sheet Light curtain transmitter

Part no.: 50131366

CSL505-T05-75-M8

### Contents

- Technical data
- Dimensioned drawings
- Electrical connection
- Operation and display
- Suitable receivers
- Part number code
- Accessories



For illustration purposes only



## Technical data

### Basic data

Series	505
Operating principle	Throughbeam principle
Device type	Transmitter
Application	Precise object detection

### Special version

Special version	Crossed-beam scanning
	Diagonal-beam scanning
	Parallel-beam scanning

### Optical data

Operating range	0.3 ... 5 m
Measurement field length	75 mm
Number of beams	16 Piece(s)
Beam spacing	5 mm
Light source	LED, Infrared
Wavelength	860 nm
Transmitted-signal shape	Pulsed

### Measurement data

Minimum object diameter	7.5 mm
-------------------------	--------

### Electrical data

Protective circuit	Inductive protection
	Polarity reversal protection
	Short circuit protected

### Performance data

Supply voltage $U_B$	18 ... 30 V, DC
----------------------	-----------------

### Connection

Number of connections	1 Piece(s)
-----------------------	------------

#### Connection 1

Function	Deactivation input
	Voltage supply
Type of connection	Connector
Thread size	M8
Type	Male
Material	Metal
No. of pins	4 -pin
Encoding	A-coded

### Mechanical data

Design	Cubic
Dimension (W x H x L)	12 mm x 58 mm x 160 mm
Housing material	Metal
Metal housing	Aluminum
Lens cover material	Plastic
Net weight	187 g
Housing color	Silver
Type of fastening	Through-hole mounting

### Operation and display

Type of display	LED
Number of LEDs	1 Piece(s)
Type of configuration	Software
	Via pin assignment

### Environmental data

Ambient temperature, operation	-30 ... 50 °C
Ambient temperature, storage	-40 ... 65 °C

### Certifications

Degree of protection	IP 65
Protection class	III

### Classification

Customs tariff number	90314990
ECLASS 5.1.4	27270910
ECLASS 8.0	27270910
ECLASS 9.0	27270910
ECLASS 10.0	27270910
ECLASS 11.0	27270910
ECLASS 12.0	27270910
ECLASS 13.0	27270910
ECLASS 14.0	27270910
ECLASS 15.0	27270910
ECLASS 16.0	27270910
ETIM 5.0	EC002549
ETIM 6.0	EC002549
ETIM 7.0	EC002549
ETIM 8.0	EC002549
ETIM 9.0	EC002549
ETIM 10.0	EC002549
UNSPSC 26.08	39121528

# Dimensioned drawings

All dimensions in millimeters

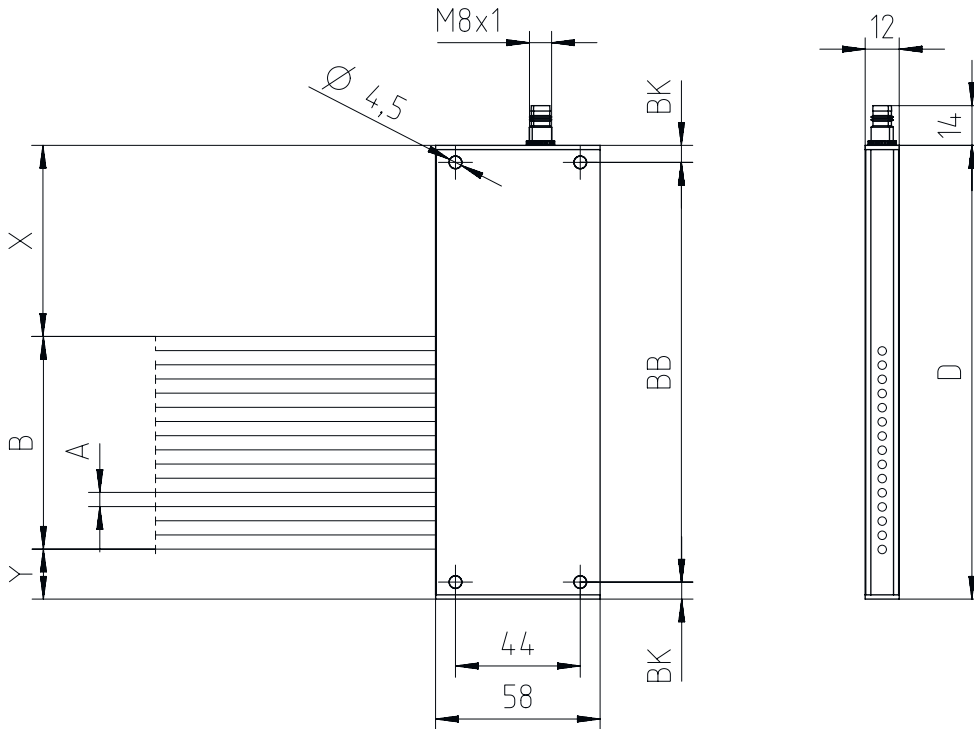

## Electrical connection

### Connection 1

Function	Deactivation input
	Voltage supply
Type of connection	Connector
Thread size	M8
Type	Male
Material	Metal
No. of pins	4 -pin
Encoding	A-coded

Pin	Pin assignment
1	V+
2	n.c.
3	GND
4	IN 1



## Operation and display

LED	Display	Meaning
1	Off	Off
	Red, continuous light	Operational readiness
	Red, flashing	Error

## Suitable receivers

Part no.	Designation	Operating range Operating range limit	Description
50131309	CSL505-R05-75-M8	0.3 ... 5 m	Application: Precise object detection Special version: Parallel-beam scanning, Crossed-beam scanning, Diagonal-beam scanning, Teach input, Warning output Digital switching outputs: 2 Piece(s) Switching output: Transistor, Push-pull, Light/dark switchable Connection: Connector, M8, 4 -pin

## Part number code

Part designation: **CSL505-YYYY-ZZZZ-AA-BBB**

<b>X</b>	<b>Operating principle</b> T: transmitter R: receiver
<b>YYY</b>	<b>Beam spacing</b> 05: 5 mm 12.5: 12.5 mm 25: 25 mm 50: 50 mm 100: 100 mm
<b>ZZZZ</b>	<b>Measurement field length</b> Measurement field length [mm], dependent on beam spacing
<b>AA</b>	<b>Electrical connection</b> M8: M8 connector, 4-pin (plug)

### Note



A list with all available device types can be found on the Leuze website at [www.leuze.com](http://www.leuze.com).

## Accessories

### Connection technology - Connection cables

Part no.	Designation	Article	Description
50130850	KD U-M8-4A-V1-050	Connection cable	Application: Chemical resistant Connection 1: Connector, M8, Axial, Female, 4 -pin Connector, LED: No Connection 2: Open end Shielded: No Cable length: 5,000 mm Sheathing material: PVC
50130871	KD U-M8-4W-V1-050	Connection cable	Application: Chemical resistant Connection 1: Connector, M8, Angled, Female, 4 -pin Connector, LED: No Connection 2: Open end Shielded: No Cable length: 5,000 mm Sheathing material: PVC

## Accessories

### Configuration devices

	Part no.	Designation	Article	Description
	50132069	CSL505-Interface	Module	Functions: Configuration and test device Connection: Sub-D

#### Note



A list with all available accessories can be found on the Leuze website in the Download tab of the article detailed page.