

## Technical data sheet

### Safety light curtain transmitter

Part no.: 68020218  
MLC500T20-1800G



#### Contents

- Technical data
- Dimensioned drawings
- Electrical connection
- Suitable receivers
- Part number code
- Notes
- Accessories



## Technical data

### Basic data

Series	MLC 500
Device type	Transmitter
Cascading	Guest
Contains	2x BT-NC sliding block
Application	Hand protection

### Characteristic parameters

Type	4, IEC/EN 61496
SIL	3, IEC 61508
SILCL	3, IEC/EN 62061
Mission time T <sub>M</sub>	20 years, EN ISO 13849-1

### Protective field data

Resolution	20 mm
Protective field height	1,800 mm
Operating range	0 ... 15 m

### Optical data

Number of beams	144 Piece(s)
Light source	LED, Infrared
Wavelength	940 nm
Transmitted-signal shape	Pulsed
LED risk group	Exempt group (in acc. with EN 62471:2008)

### Connection

Number of connections	1 Piece(s)
-----------------------	------------

#### Connection 1

Function	Cascade, Host In Cascade, Middle Guest In
Type of connection	Cable with connector
Cable length	330 mm
Sheathing material	PUR
Thread size	M12
Material	Plastic
No. of pins	8 -pin

### Mechanical data

Dimension (W x H x L)	29 mm x 1,814 mm x 53 mm
Housing material	Metal
Metal housing	Aluminum
Lens cover material	Plastic / PMMA
Material of end caps	Diecast zinc
Net weight	1,923 g
Housing color	Yellow, RAL 1021
Type of fastening	Groove mounting Mounting brackets Swivel mount

### Environmental data

Ambient temperature, operation	0 ... 55 °C
Ambient temperature, storage	-30 ... 70 °C
Relative humidity (non-condensing)	0 ... 95 %

### Certifications

Degree of protection	IP 65
Protection class	III
Certifications	c TÜV NRTL US c UL US TÜV Süd
Vibration resistance	50 m/s <sup>2</sup>
Shock resistance	100 m/s <sup>2</sup>
US patents	US 6,418,546 B

### Classification

Customs tariff number	85365019
ECLASS 5.1.4	27272704
ECLASS 8.0	27272704
ECLASS 9.0	27272704
ECLASS 10.0	27272704
ECLASS 11.0	27272704
ECLASS 12.0	27272704
ECLASS 13.0	27272704
ECLASS 14.0	27272704
ETIM 5.0	EC002549
ETIM 6.0	EC002549
ETIM 7.0	EC002549
ETIM 8.0	EC002549
ETIM 9.0	EC002549

# Dimensioned drawings

All dimensions in millimeters

Calculation of the effective protective field height  $H_{PFE} = H_{PFN} + B + C$

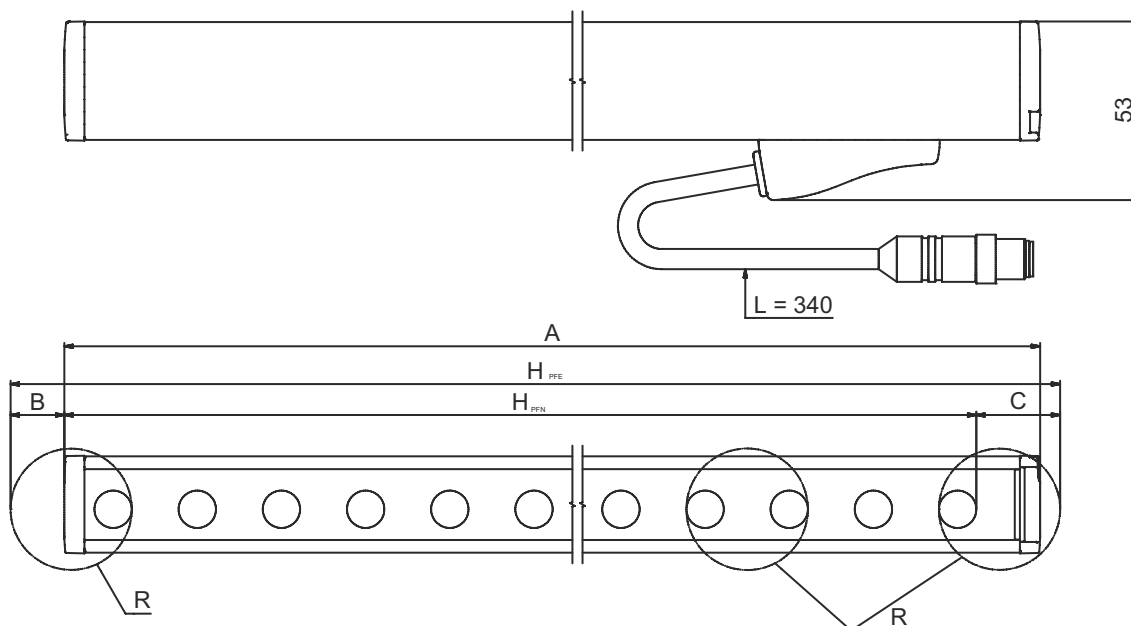

$H_{PFE}$  Effective protective field height = 1817 mm  
 $H_{PFN}$  Nominal protective field height = 1800 mm  
 A Total height = 1814 mm  
 B 7 mm

C 10 mm  
 R Effective protective field height  $H_{PFE}$  goes beyond the dimensions of the optics area to the outer borders of the circles labeled with R.

## Electrical connection

### Connection 1

Function	Cascade, Host In Cascade, Middle Guest In
Type of connection	Cable with connector
Cable length	330 mm
Sheathing material	PUR
Cable color	Black
Type of stranding	Pair stranding (twisted pair)
Wire cross section	0.14 mm <sup>2</sup>
Thread size	M12
Type	Male
Material	Plastic
No. of pins	8 -pin
Encoding	A-coded

## Suitable receivers

	Part no.	Designation	Article	Description
	68021218	MLC520R20-1800G	Safety light curtain receiver	Resolution: 20 mm Protective field height: 1,800 mm Response time: 30 ms Connection: Cable with connector, M12, Plastic, 8 -pin, 330 mm, PUR

# Part number code

Part designation: **MLCxyy-za-hhhhei-ooo**

<b>MLC</b>	<b>Safety light curtain</b>
<b>x</b>	<b>Series</b> 3: MLC 300 5: MLC 500
<b>yy</b>	<b>Function classes</b> 00: transmitter 01: transmitter (AIDA) 02: transmitter with test input 10: basic receiver - automatic restart 11: basic receiver - automatic restart (AIDA) 20: standard receiver - EDM/RES selectable 30: extended receiver - blanking/muting
<b>z</b>	<b>Device type</b> T: transmitter R: receiver
<b>a</b>	<b>Resolution</b> 14: 14 mm 20: 20 mm 30: 30 mm 40: 40 mm 90: 90 mm
<b>hhhh</b>	<b>Protective field height</b> 150 ... 3000: from 150 mm to 3000 mm
<b>e</b>	<b>Host/Guest (optional)</b> H: Host MG: Middle Guest G: Guest
<b>i</b>	<b>Interface (optional)</b> /A: AS-i
<b>ooo</b>	<b>Option</b> /V: high Vibration-proof EX2: explosion protection (zones 2 + 22) SPG: Smart Process Gating

**Note**



A list with all available device types can be found on the Leuze website at [www.leuze.com](http://www.leuze.com).

## Notes

 **Observe intended use!**



- The product may only be put into operation by competent persons.
- Only use the product in accordance with its intended use.

## Accessories

### Connection technology - Interconnection cables

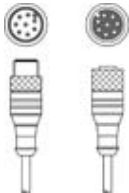
	Part no.	Designation	Article	Description
	429278	CB-M12-2000E-8TP	Interconnection cable	Connection 1: Connector, M12, Axial, Female, A-coded, 8 -pin Connection 2: Connector, M12, Axial, Male, A-coded, 8 -pin Shielded: Yes Cable length: 2,000 mm Sheathing material: PUR

### Mounting technology - Mounting brackets

	Part no.	Designation	Article	Description
	429006	BT-2L-HG	Mounting device set	Mounting bracket, at device: Screw type Material: Metal



### Mounting technology - Swivel mounts

	Part no.	Designation	Article	Description
	429395	BT-2HF-G	Mounting bracket set	Fastening, at system: Through-hole mounting Mounting bracket, at device: Clampable Type of mounting device: Turning, 360° Material: Metal, Plastic

### Alignment aids

	Part no.	Designation	Article	Description
	520101	AC-ALM-M	Alignment aid	Housing material: Plastic

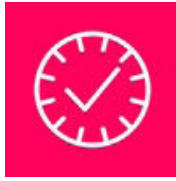
### Services

	Part no.	Designation	Article	Description
	S981050	CS40-I-140	Safety inspection	Details: Checking of a safety light barrier application in accordance with current standards and guidelines. Inclusion of the device and machine data in a database, production of a test log per application. Conditions: It must be possible to stop the machine, support provided by customer's employees and access to the machine for Leuze employees must be ensured.
	S981046	CS40-S-140	Start-up support	Details: For safety devices including stopping time measurement and initial inspection. Conditions: Devices and connection cables are already mounted, price not including travel costs and, if applicable, accommodation expenses.

## Accessories

### Note



🔗 A list with all available accessories can be found on the Leuze website in the Download tab of the article detailed page.