

## Technical data sheet Light curtain receiver

Part no.: 50146820

CSL710-R40-2210.A/L-M12-67



### Contents

- Technical data
- Dimensioned drawings
- Electrical connection
- Operation and display
- Suitable transmitters
- Part number code
- Notes
- Accessories



## Technical data

### Basic data

Series	710
Operating principle	Throughbeam principle
Device type	Receiver
Application	Precise object detection

### Special version

Special version	Crossed-beam scanning
	Diagonal-beam scanning
	Parallel-beam scanning

### Characteristic parameters

#### Optical data

Operating range	0.3 ... 7 m
Operating range	Guaranteed operating range
Operating range limit	0.2 ... 9 m
Operating range limit	Typical operating range
Measurement field length	2,210 mm
Number of beams	56 Piece(s)
Beam spacing	40 mm

#### Measurement data

Minimum object diameter	50 mm
-------------------------	-------

#### Electrical data

Protective circuit	Polarity reversal protection
	Short circuit protected
	Transient protection

#### Performance data

Supply voltage $U_B$	18 ... 30 V, DC
Residual ripple	0 ... 15 %, From $U_B$
Open-circuit current	0 ... 435 mA, The specified values refer to the entire package consisting of transmitter and receiver.

#### Inputs/outputs selectable

Output current, max.	100 mA
Input resistance	6,000 $\Omega$
Number of inputs/outputs selectable	4 Piece(s)
Type	Inputs/outputs selectable
Voltage type, outputs	DC
Switching voltage, outputs	Typ. $U_B / 0$ V
Voltage type, inputs	DC
Switching voltage, inputs	high: $\geq 6$ V
	low: $\leq 4$ V

#### Input/output 1

Activation/disable delay	0 ... 1 ms
--------------------------	------------

### Time behavior

Readiness delay	400 ms
Cycle time	2.08 ms
Response time per beam	30 $\mu$ s

### Interface

Type	IO-Link
------	---------

### IO-Link

COM mode	COM2
	COM3
Min. cycle time	COM2 = 2.3 ms
Specification	V1.0.1
	V1.1
Process data IN	2 bytes
Process data OUT	2 bytes

### Service interface

Type	IO-Link
------	---------

### IO-Link

Function	Configuration via software
	Service

### Connection

Number of connections	2 Piece(s)
Plug outlet	Axial

#### Connection 1

Function	Configuration interface
	Signal IN
	Signal OUT
	Voltage supply
Type of connection	Connector
Thread size	M12
Type	Male
Material	Metal
No. of pins	8 -pin
Encoding	A-coded

#### Connection 2

Function	Connection to transmitter
Type of connection	Connector
Thread size	M12
Type	Female
Material	Metal
No. of pins	5 -pin
Encoding	A-coded

### Mechanical data

Design	Cubic
Dimension (W x H x L)	30.4 mm x 54.8 mm x 2,313 mm
Housing material	Metal
Metal housing	Aluminum
Lens cover material	Plastic / PMMA
Net weight	2,250 g
Housing color	Red
Type of fastening	Groove mounting
	Via optional mounting device

### Operation and display

Type of display	LED
	OLED display
Number of LEDs	2 Piece(s)
Type of configuration	Software
	Teach-in
Operational controls	Membrane keyboard

## Technical data

### Environmental data

Ambient temperature, operation	-30 ... 60 °C
Ambient temperature, storage	-40 ... 70 °C

### Certifications

Degree of protection	IP 67
Protection class	III
Certifications	c UL US
Standards applied	IEC 60947-5-2

### Classification

Customs tariff number	90314990
ECLASS 5.1.4	27270910
ECLASS 8.0	27270910
ECLASS 9.0	27270910
ECLASS 10.0	27270910
ECLASS 11.0	27270910
ECLASS 12.0	27270910
ECLASS 13.0	27270910
ECLASS 14.0	27270910
ETIM 5.0	EC002549
ETIM 6.0	EC002549
ETIM 7.0	EC002549
ETIM 8.0	EC002549
ETIM 9.0	EC002549

# Dimensioned drawings

All dimensions in millimeters

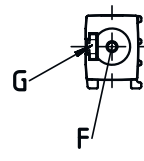
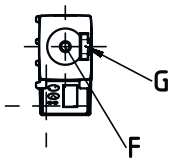
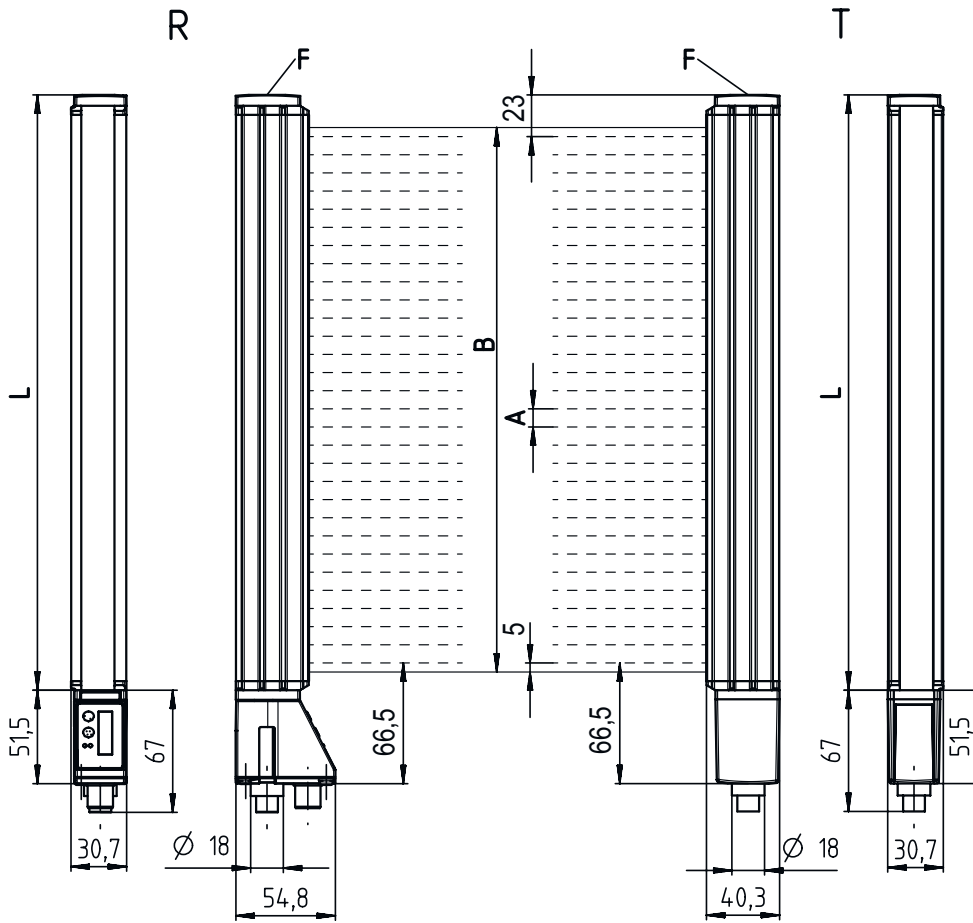

- |   |                                  |   |                        |
|---|----------------------------------|---|------------------------|
| A | Beam spacing 40 mm               | L | Profile length 2248 mm |
| B | Measurement field length 2210 mm | T | Transmitter            |
| F | M6 thread                        | R | Receiver               |
| G | Fastening groove                 | Y |                        |

# Dimensioned drawings



## Electrical connection

### Connection 1

Function	Configuration interface
	Signal IN
	Signal OUT
	Voltage supply
Type of connection	Connector
Thread size	M12
Type	Male
Material	Metal
No. of pins	8 -pin
Encoding	A-coded

Pin	Pin assignment
-----	----------------

1	V+
2	IO1
3	GND
4	IO-Link
5	IO2
6	IO3
7	IO4
8	GND



### Connection 2

Function	Connection to transmitter
Type of connection	Connector
Thread size	M12
Type	Female
Material	Metal
No. of pins	5 -pin
Encoding	A-coded

Pin	Pin assignment
-----	----------------

1	FE/SHIELD
2	V+
3	GND
4	RS 485 Tx+
5	RS 485 Tx-



# Operation and display

LED	Display	Meaning
1	Green, continuous light	Operational readiness
	Green, flashing	Teach / error
2	Yellow, continuous light	Light path free, with function reserve
	Yellow, flashing	No function reserve
	Off	Object detected

## Suitable transmitters

	Part no.	Designation	Article	Description
	50129055	CSL710-T40-2210.A-M12	Light curtain transmitter	Application: Precise object detection Special version: Parallel-beam scanning, Crossed-beam scanning, Diagonal-beam scanning Operating range: 0.3 ... 7 m Connection: Connector, M12, 5 -pin

## Part number code



Part designation: **CSL710-XYZ-ZZZZ.A/B-CCC**

<b>CSL710</b>	<b>Operating principle</b> CSL: switching light curtain of the 710 series
<b>X</b>	<b>Function classes</b> T: transmitter R: receiver
<b>YY</b>	<b>Beam spacing</b> 05: 5 mm 10: 10 mm 20: 20 mm 40: 40 mm
<b>ZZZZ</b>	<b>Measurement field length [mm], dependent on beam spacing</b> Value, see technical data
<b>A</b>	<b>Equipment</b> A: Axial connector outlet
<b>B</b>	<b>Interface</b> L: IO-Link
<b>CCC</b>	<b>Electrical connection</b> M12: M12 connector

### Note

	A list with all available device types can be found on the Leuze website at <a href="http://www.leuze.com">www.leuze.com</a> .
--	--

## Notes

 <b>Observe intended use!</b>	
	<ul style="list-style-type: none"> <li>This product is not a safety sensor and is not intended as personnel protection.</li> <li>The product may only be put into operation by competent persons.</li> <li>Only use the product in accordance with its intended use.</li> </ul>

## Notes

### For UL applications:



- ↪ For UL applications, use is only permitted in Class 2 circuits in accordance with the NEC (National Electric Code).
- ↪ These proximity switches shall be used with UL Listed Cable assemblies rated 30V, 0.5A min, in the field installation, or equivalent (categories: CYJV/ CYJV7 or PVVA/PVVA7)

## Accessories

### Connection technology - Connection cables

	Part no.	Designation	Article	Description
	50135128	KD S-M12-8A-P1-050	Connection cable	Connection 1: Connector, M12, Axial, Female, A-coded, 8 -pin Connector, LED: No Connection 2: Open end Shielded: Yes Cable length: 5.000 mm Sheathing material: PUR

### Connection technology - Interconnection cables

	Part no.	Designation	Article	Description
	50129781	KDS DN-M12-5A-M12-5A-P3-050	Interconnection cable	Suitable for interface: DeviceNet, CANopen Connection 1: Connector, M12, Axial, Female, A-coded, 5 -pin Connection 2: Connector, M12, Axial, Male, A-coded, 5 -pin Shielded: Yes Cable length: 5,000 mm Sheathing material: PUR

### Note



- ↪ A list with all available accessories can be found on the Leuze website in the Download tab of the article detailed page.