

Technical data sheet Light curtain receiver

Part no.: 50147204

CML730i-R40-1570.R/PN-M12-67



For illustration purposes only

Contents

- Technical data
- Dimensioned drawings
- Electrical connection
- Operation and display
- Suitable transmitters
- Part number code
- Notes
- Accessories



Technical data

Basic data

Series	730
Operating principle	Throughbeam principle
Device type	Receiver
Contains	Accessories for the use of the BT-2R1
Application	Detection of transparent objects Object measurement

Special version

Special version	Crossed-beam scanning Diagonal-beam scanning Parallel-beam scanning
-----------------	---

Optical data

Operating range	0.3 ... 9.5 m
Operating range	Guaranteed operating range
Operating range, transparent media	0.3 ... 3.5 m
Operating range limit	0.2 ... 12 m
Operating range limit	Typical operating range
Measurement field length	1,570 mm
Number of beams	39 Piece(s)
Beam spacing	40 mm

Measurement data

Minimum object diameter	50 mm
-------------------------	-------

Electrical data

Protective circuit	Polarity reversal protection Short circuit protected Transient protection
--------------------	---

Performance data

Supply voltage U_B	18 ... 30 V, DC
Residual ripple	0 ... 15 %, From U_B
Open-circuit current	0 ... 350 mA, The specified values refer to the entire package consisting of transmitter and receiver.

Inputs/outputs selectable

Output current, max.	100 mA
Input resistance	6,000 Ω
Number of inputs/outputs selectable	2 Piece(s)
Type	Inputs/outputs selectable
Voltage type, outputs	DC
Switching voltage, outputs	Typ. U_B / 0 V
Voltage type, inputs	DC
Switching voltage, inputs	high: $\geq 6V$ low: $\leq 4 V$

Input/output 1

Activation/disable delay	1 ms
--------------------------	------

Time behavior

Readiness delay	1,500 ms
Cycle time	1 ms
Response time per beam	10 μs

Interface

Type	PROFINET
------	----------

PROFINET

Function	Process
Conformance class	B
Protocol	PROFINET RT
Switch functionality	Integrated
Transmission speed	10 Mbit/s 100 Mbit/s

Service interface

Type	IO-Link
IO-Link	
Function	Configuration via software Service

Connection

Number of connections	3 Piece(s)
Plug outlet	Rear side

Connection 1

Function	Configuration interface Connection to transmitter Signal IN Signal OUT Voltage supply
Type of connection	Connector
Thread size	M12
Type	Male
Material	Metal
No. of pins	8 -pin
Encoding	A-coded

Connection 2

Function	BUS IN
Type of connection	Connector
Thread size	M12
Type	Female
Material	Metal
No. of pins	4 -pin
Encoding	D-coded

Connection 3

Function	BUS OUT
Type of connection	Connector
Thread size	M12
Type	Female
Material	Metal
No. of pins	4 -pin
Encoding	D-coded

Mechanical data

Design	Cubic
Dimension (W x H x L)	31 mm x 117 mm x 1,618 mm
Housing material	Metal
Metal housing	Aluminum
Lens cover material	Plastic
Net weight	1,800 g
Housing color	Silver
Type of fastening	Groove mounting Via optional mounting device

Technical data

Operation and display

Type of display	LED OLED display
Number of LEDs	4 Piece(s)
Type of configuration	Software Teach-in
Operational controls	Membrane keyboard

Environmental data

Ambient temperature, operation	-30 ... 60 °C
Ambient temperature, storage	-40 ... 70 °C

Certifications

Degree of protection	IP 67
Protection class	III
Certifications	c UL US
Standards applied	IEC 60947-5-2

Classification

Customs tariff number	90314990
ECLASS 5.1.4	27270910
ECLASS 8.0	27270910
ECLASS 9.0	27270910
ECLASS 10.0	27270910
ECLASS 11.0	27270910
ECLASS 12.0	27270910
ECLASS 13.0	27270910
ECLASS 14.0	27270910
ETIM 5.0	EC002549
ETIM 6.0	EC002549
ETIM 7.0	EC002549
ETIM 8.0	EC002549
ETIM 9.0	EC002549

Dimensioned drawings

All dimensions in millimeters

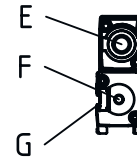
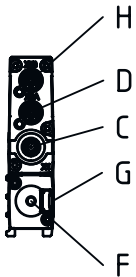
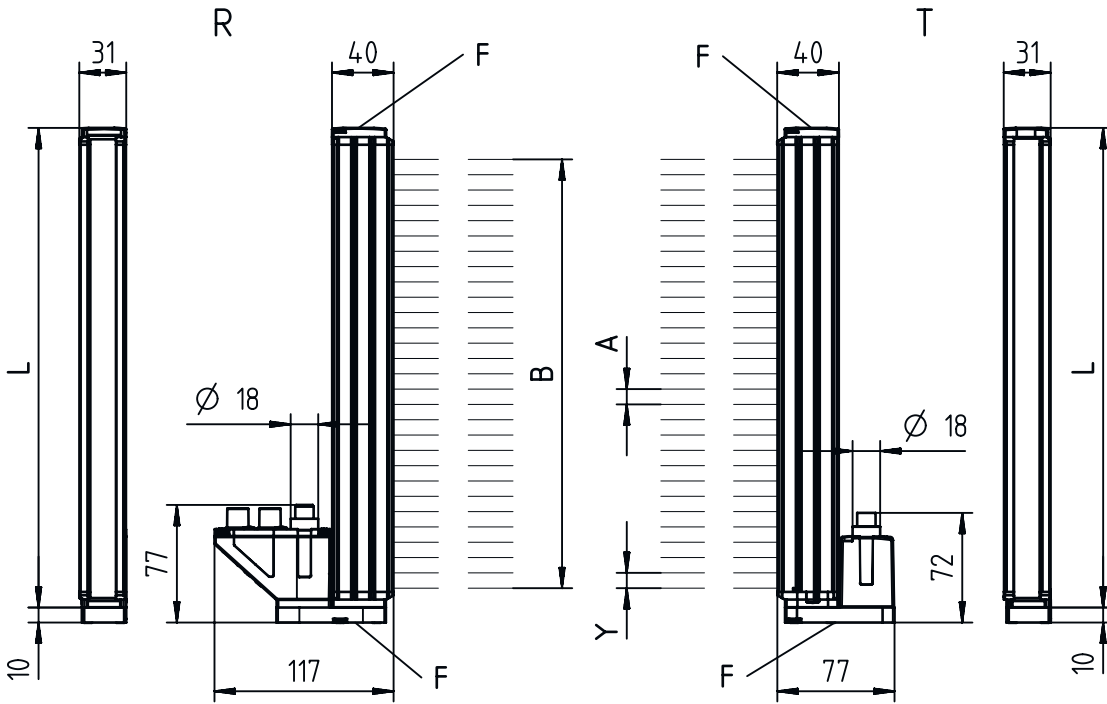

- | | | | |
|---|----------------------------------|---|------------------------|
| A | Beam spacing 40 mm | L | Profile length 1608 mm |
| B | Measurement field length 1570 mm | T | Transmitter |
| F | M6 thread | R | Receiver |
| G | Fastening groove | Y | 5 mm |

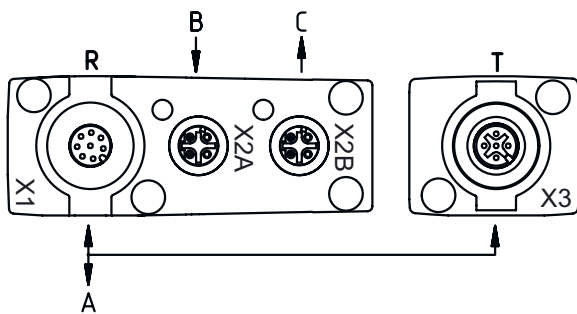

- A PWR / SW IN / OUT
- B BUS IN
- C BUS OUT

Electrical connection

Connection 1

X1

Function	Configuration interface Connection to transmitter Signal IN Signal OUT Voltage supply
Type of connection	Connector
Thread size	M12
Type	Male
Material	Metal
No. of pins	8 -pin
Encoding	A-coded

Pin	Pin assignment
-----	----------------

1	V+
2	I/O 1
3	GND
4	IO-Link
5	I/O 2
6	RS 485 Tx+
7	RS 485 Tx+
8	FE/SHIELD

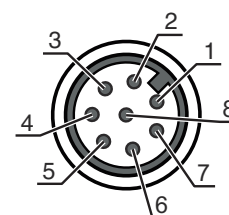

Connection 2

X2A

Function	BUS IN
Type of connection	Connector
Thread size	M12
Type	Female
Material	Metal
No. of pins	4 -pin
Encoding	D-coded

Pin	Pin assignment
-----	----------------

1	TD0+
2	RD0+
3	TD0-
4	RD0-

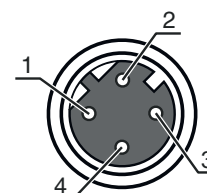

Connection 3

X2B

Function	BUS OUT
Type of connection	Connector
Thread size	M12
Type	Female
Material	Metal
No. of pins	4 -pin
Encoding	D-coded

Pin	Pin assignment
-----	----------------

1	TD0+
2	RD0+
3	TD0-
4	RD0-

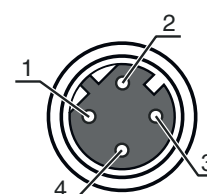

Operation and display

LED	Display	Meaning
1	Green, continuous light	Operational readiness
	Green, flashing	Teach / error
2	Yellow, continuous light	Light path free, with function reserve
	Yellow, flashing	No function reserve
	Off	Object detected
3	Green, continuous light (at the X2A / X2B connector)	Link
4	Yellow, continuous light (at the X2A / X2B connector)	Activity

Suitable transmitters

	Part no.	Designation	Article	Description
	50147205	CML730i-T40-1570.R-M12-67	Light curtain transmitter	Operating range: 0.3 ... 9.5 m Connection: Connector, M12, Rear side, 5 -pin

Part number code

Part designation: CML7XXi-YYZ-AAAA.BCCDDDD-EEEEFF

CML	Operating principle Measuring light curtain
7XXi	Series 720i: 720i series 730i: 730i series
Y	Device type T: transmitter R: receiver
ZZ	Beam spacing 05: 5 mm 10: 10 mm 20: 20 mm 40: 40 mm
AAAA	Measurement field length [mm], dependent on beam spacing
B	Equipment A: Axial connector outlet R: Rear connector outlet
CCC	Interface L: IO-Link /CN: CANopen /PB: PROFIBUS /PN: PROFINET /CV: Analog current and voltage output /D3: RS 485 Modbus
DDD	Special equipment -PS: Power Setting
EEE	Electrical connection M12: M12 connector
FFF	-EX: Explosion protection

Note



A list with all available device types can be found on the Leuze website at www.leuze.com.

Notes

⚠ Observe intended use!

This product is not a safety sensor and is not intended as personnel protection.
 ⚠ The product may only be put into operation by competent persons.
 ⚠ Only use the product in accordance with its intended use.

For UL applications:

For UL applications, use is only permitted in Class 2 circuits in accordance with the NEC (National Electric Code).
 ⚠ These proximity switches shall be used with UL Listed Cable assemblies rated 30V, 0.5A min, in the field installation, or equivalent (categories: CYJV/ CYJV7 or PVVA/PVVA7)

Accessories

Connection technology - Connection cables

	Part no.	Designation	Article	Description
	50132079	KD U-M12-5A-V1-050	Connection cable	Connection 1: Connector, M12, Axial, Female, A-coded, 5 -pin Connector, LED: No Connection 2: Open end Shielded: No Cable length: 5.000 mm Sheathing material: PVC
	50135074	KS ET-M12-4A-P7-050	Connection cable	Suitable for interface: Ethernet Connection 1: Connector, M12, Axial, Male, D-coded, 4 -pin Connector, LED: No Connection 2: Open end Shielded: Yes Cable length: 5.000 mm Sheathing material: PUR

Connection technology - Interconnection cables

	Part no.	Designation	Article	Description
	50135081	KSS ET-M12-4A-RJ45-A-P7-050	Interconnection cable	Suitable for interface: Ethernet Connection 1: Connector, M12, Axial, Male, D-coded, 4 -pin Connection 2: RJ45 Shielded: Yes Cable length: 5,000 mm Sheathing material: PUR

Accessories

Connection technology - Y distribution cables

	Part no.	Designation	Article	Description
	50118183	K-Y1 M12A-5m-M12A-S-PUR	Interconnection cable	Connection 1: Connector, M12, Axial, Female, A-coded, 5 -pin Connection 2: Connector, M12, Axial, Male, A-coded, 5 -pin Connection 3: Connector, M12, Axial, Female, A-coded, 8 -pin Shielded: Yes Cable length fork 1: 5,000 mm Cable length fork 2: 150 mm Sheathing material: PUR

Mounting technology - Mounting brackets

	Part no.	Designation	Article	Description
	50142900	BT 700M.5-2SET	Mounting device set	Design of mounting device: Bracket mounting Fastening, at system: Through-hole mounting, T slotted hole Mounting bracket, at device: Screw type, Sliding block Type of mounting device: Rigid Material: Steel

Mounting technology - Swivel mounts

	Part no.	Designation	Article	Description
	429029	BT-2RG	Mounting bracket set	Fastening, at system: Through-hole mounting Mounting bracket, at device: Clampable Type of mounting device: Turning, 360° Material: Metal, Plastic

Configuration devices

	Part no.	Designation	Article	Description
	50121098	SET MD12-US2-IL1.1 + Zub.	Diagnostics set	Interface: USB Connections: 2 Piece(s) Degree of protection: IP 20

Services

	Part no.	Designation	Article	Description
	S981001	CS10-S-110	Start-up support	Details: Performed at location of customer's choosing, duration: max. 10 hours. Conditions: Devices and connection cables are already mounted, price not including travel costs and, if applicable, accommodation expenses.
	S981005	CS10-T-110	Product training	Details: Location and content to be agreed upon, duration: max. 10 hours. Conditions: Price not including travel costs and, if applicable, accommodation expenses.

Accessories

Note



🔗 A list with all available accessories can be found on the Leuze website in the Download tab of the article detailed page.