

Technical data sheet

Connection cable

Part no.: 50135074

KS ET-M12-4A-P7-050

Contents

- Technical data
- Electrical connection
- Circuit diagrams

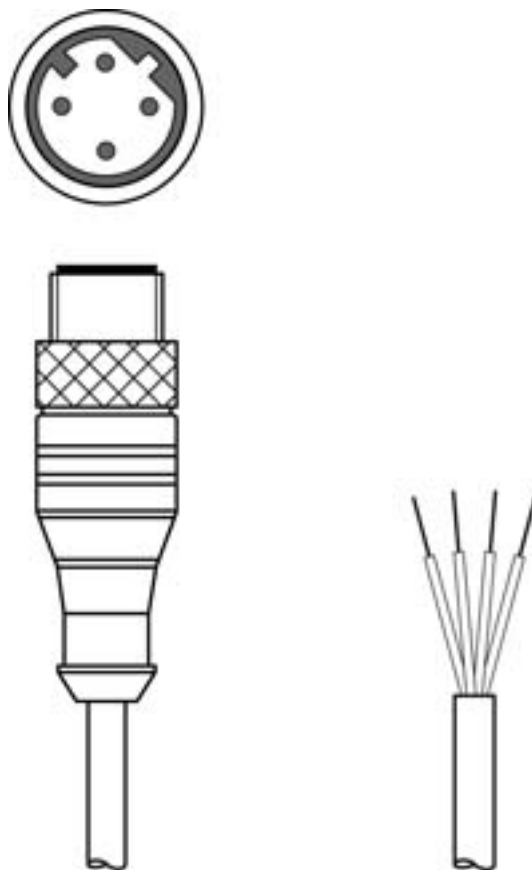

For illustration purposes only



Technical data

Basic data

Application	Oil and lubricant resistant
Suitable for interface	Ethernet

Electrical data

Performance data

Operating voltage	60 V DC
-------------------	---------

Connection

Connection 1

Type of connection	Connector
Thread size	M12
Type	Male
Handle body material	PUR
No. of pins	4 -pin
Encoding	D-coded
Version	Axial
Connector, LED	No
Lock	Screw fitting, nickel-plated diecast zinc, recommended torque 0.6 Nm, self-locking

Connection 2

Type of connection	Open end
--------------------	----------

Cable properties

Number of conductors	4 Piece(s)
Wire cross section	0.34 mm ²
AWG	22
Sheathing color	Green
Shielded	Yes
Silicone-free	Yes
Cable design	Connection cable (open on one end)
Cable diameter (external)	6.7 mm
Cable length	5,000 mm
Sheathing material	PUR
Wire insulation	PP
Traverse rate	Max. 3.3 m/s with horiz. traverse path of 5m and and max. acceleration of 2m/s ²

Suitability for drag chains	Yes
-----------------------------	-----

Properties of the outer sheathing	Free of CFC, cadmium, silicone, halogen and lead, matt, low-adhesion, abrasion-resistant, easily machine-processable
-----------------------------------	--

Resistance of the outer sheathing	Hydrolysis and microbe resistant, good oil, gasoline and chemical resistance in accordance with VDE 0472 part 803 test B, flame retardant in accordance with UL 1581 VW1 / CSA FT1 / IEC 60332-1, IEC 60332-2-2
-----------------------------------	---

Mechanical data

Width across flats	13 mm
Net weight	294 g
Bending cycles	2,000,000 Piece(s)
Bending radius, flexible laying, min.	Min. 15 x cable diameter
Bending radius, stationary laying, min.	One-time min. 5 x cable diameter

Operation and display

Environmental data

Ambient temperature, operation, flexible use	-20 ... 60 °C
Ambient temperature, operation, stationary use	-20 ... 60 °C

Certifications

Degree of protection	IP 65
	IP 67

Classification

Customs tariff number	85444290
ECLASS 5.1.4	27279201
ECLASS 8.0	27279218
ECLASS 9.0	27060311
ECLASS 10.0	27060311
ECLASS 11.0	27060311
ECLASS 12.0	27060311
ECLASS 13.0	27060311
ECLASS 14.0	27060311
ECLASS 15.0	27060311
ECLASS 16.0	27060311
ETIM 5.0	EC001855
ETIM 6.0	EC001855
ETIM 7.0	EC001855
ETIM 8.0	EC001855
ETIM 9.0	EC001855
ETIM 10.0	EC001855
UNSPSC 26.08	26121604

Electrical connection

Connection 1

Type of connection	Connector
Thread size	M12
Type	Male
Handle body material	PUR

Electrical connection

Connection 1

No. of pins	4 -pin
Encoding	D-coded
Version	Axial
Connector, LED	No
Lock	Screw fitting, nickel-plated diecast zinc, recommended torque 0.6 Nm, self-locking

Pin	Conductor color
1	Yellow
2	White
3	Orange
4	Blue



Connection 2

Type of connection	Open end
--------------------	----------

Circuit diagrams

Wiring schematic

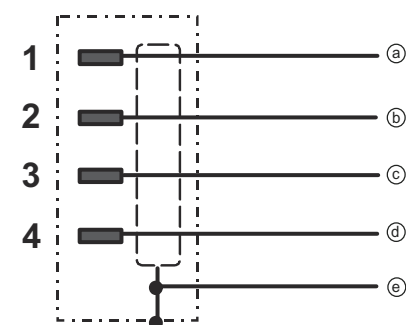

- a Yellow wire
- b White wire
- c Orange wire
- d Blue wire
- e Shield