

## Technical data sheet Light curtain receiver

Part no.: 50119727

CML720i-R05-1040.A/L-M12



### Contents

- Technical data
- Dimensioned drawings
- Electrical connection
- Operation and display
- Suitable transmitters
- Part number code
- Notes
- Accessories



## Technical data

### Basic data

Series	720
Operating principle	Throughbeam principle
Device type	Receiver
Contains	2x BT-NC sliding block
Application	Object measurement

### Special version

Special version	Crossed-beam scanning
	Diagonal-beam scanning
	Parallel-beam scanning

### Optical data

Operating range	0.1 ... 3.5 m
Operating range	Guaranteed operating range
Operating range limit	0.1 ... 4.5 m
Operating range limit	Typical operating range
Measurement field length	1,040 mm
Number of beams	208 Piece(s)
Beam spacing	5 mm

### Measurement data

Minimum object diameter	10 mm
-------------------------	-------

### Electrical data

Protective circuit	Polarity reversal protection
	Short circuit protected
	Transient protection

### Performance data

Supply voltage $U_B$	18 ... 30 V, DC
Residual ripple	0 ... 15 %, From $U_B$
Open-circuit current	0 ... 270 mA, The specified values refer to the entire package consisting of transmitter and receiver.

### Inputs/outputs selectable

Output current, max.	100 mA
Input resistance	6,000 $\Omega$
Number of inputs/outputs selectable	4 Piece(s)
Type	Inputs/outputs selectable
Voltage type, outputs	DC
Switching voltage, outputs	Typ. $U_B$ / 0 V
Voltage type, inputs	DC
Switching voltage, inputs	high: $\geq 6V$
	low: $\leq 4 V$

### Input/output 1

Activation/disable delay	0 ... 1 ms
--------------------------	------------

### Time behavior

Readiness delay	400 ms
Cycle time	6.64 ms
Response time per beam	30 $\mu s$

### Interface

Type	IO-Link
------	---------

### IO-Link

COM mode	COM2
Min. cycle time	COM2 = 2.3 ms
Specification	V1.0.1
	V1.1

### Service interface

Type	IO-Link
------	---------

### IO-Link

Function	Configuration via software
	Service

### Connection

Number of connections	2 Piece(s)
Plug outlet	Axial

### Connection 1

Function	Configuration interface
	Signal IN
	Signal OUT
	Voltage supply

Type of connection	Connector
Thread size	M12
Type	Male
Material	Metal
No. of pins	8 -pin
Encoding	A-coded

### Connection 2

Function	Connection to transmitter
Type of connection	Connector
Thread size	M12
Type	Female
Material	Metal
No. of pins	5 -pin
Encoding	A-coded

### Mechanical data

Design	Cubic
Dimension (W x H x L)	29 mm x 35.4 mm x 1,115 mm
Housing material	Metal
Metal housing	Aluminum
Lens cover material	Plastic
Net weight	1,250 g
Housing color	Silver
Type of fastening	Groove mounting
	Via optional mounting device

### Operation and display

Type of display	LED
	OLED display
Number of LEDs	2 Piece(s)
Type of configuration	Software
	Teach-in
Operational controls	Membrane keyboard

### Environmental data

Ambient temperature, operation	-30 ... 60 °C
Ambient temperature, storage	-40 ... 70 °C

## Technical data

### Certifications

Degree of protection	IP 65
Protection class	III
Approvals	c UL US
Standards applied	IEC 60947-5-2

### Classification

Customs tariff number	90314990
ECLASS 5.1.4	27270910
ECLASS 8.0	27270910
ECLASS 9.0	27270910
ECLASS 10.0	27270910
ECLASS 11.0	27270910
ECLASS 12.0	27270910
ECLASS 13.0	27270910
ECLASS 14.0	27270910
ECLASS 15.0	27270910
ETIM 5.0	EC002549
ETIM 6.0	EC002549
ETIM 7.0	EC002549
ETIM 8.0	EC002549
ETIM 9.0	EC002549
ETIM 10.0	EC002549

# Dimensioned drawings

All dimensions in millimeters



- |   |                                  |   |                        |
|---|----------------------------------|---|------------------------|
| A | Beam spacing 5 mm                | L | Profile length 1048 mm |
| B | Measurement field length 1040 mm | T | Transmitter            |
| F | M6 thread                        | R | Receiver               |
| G | Fastening groove                 | Y | 2.5 mm                 |

# Dimensioned drawings

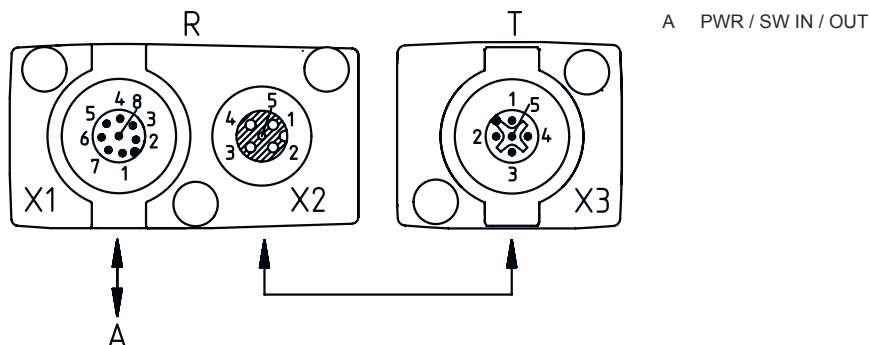

## Electrical connection

### Connection 1

Function	Configuration interface
	Signal IN
	Signal OUT
	Voltage supply
Type of connection	Connector
Thread size	M12
Type	Male
Material	Metal
No. of pins	8 -pin
Encoding	A-coded

Pin	Pin assignment
1	V+
2	IO1
3	GND
4	IO-Link
5	IO2
6	IO3
7	IO4
8	GND



### Connection 2

Function	Connection to transmitter
Type of connection	Connector
Thread size	M12
Type	Female
Material	Metal
No. of pins	5 -pin
Encoding	A-coded

Pin	Pin assignment
1	FE/SHIELD
2	V+
3	GND
4	RS 485 Tx+
5	RS 485 Tx-



## Operation and display

LED	Display	Meaning
1	Green, continuous light	Operational readiness
	Green, flashing	Teach / error
2	Yellow, continuous light	Light path free, with function reserve
	Yellow, flashing	No function reserve
	Off	Object detected

## Suitable transmitters

	Part no.	Designation	Article	Description
	50119380	CML720i-T05-1040.A-M12	Light curtain transmitter	Operating range: 0.1 ... 3.5 m Connection: Connector, M12, Axial, 5 -pin

## Part number code

Part designation: **CML7XXi-YZZ-AAAA.BCCDDDD-EEEEFFF**

<b>CML</b>	<b>Operating principle</b> Measuring light curtain
<b>7XXi</b>	<b>Series</b> 720i: 720i series 730i: 730i series
<b>Y</b>	<b>Device type</b> T: transmitter R: receiver
<b>ZZ</b>	<b>Beam spacing</b> 05: 5 mm 10: 10 mm 20: 20 mm 40: 40 mm
<b>AAAA</b>	Measurement field length [mm], dependent on beam spacing
<b>B</b>	<b>Equipment</b> A: Axial connector outlet R: Rear connector outlet
<b>CCC</b>	<b>Interface</b> L: IO-Link /CN: CANopen /PB: PROFIBUS /PN: PROFINET /CV: Analog current and voltage output /D3: RS 485 Modbus
<b>DDD</b>	<b>Special equipment</b> -PS: Power Setting
<b>EEE</b>	<b>Electrical connection</b> M12: M12 connector
<b>FFF</b>	<b>-EX: Explosion protection</b>

### Note



A list with all available device types can be found on the Leuze website at [www.leuze.com](http://www.leuze.com).

## Notes

### Observe intended use!



- ⚠ This product is not a safety sensor and is not intended as personnel protection.
- ⚠ The product may only be put into operation by competent persons.
- ⚠ Only use the product in accordance with its intended use.

### For UL applications:



- ℹ For UL applications, use is only permitted in Class 2 circuits in accordance with the NEC (National Electric Code).
- ℹ These proximity switches shall be used with UL Listed Cable assemblies rated 30V, 0.5A min, in the field installation, or equivalent (categories: CYJV/ CYJV7 or PVVA/PVVA7)

## Accessories

### Connection technology - Connection unit

	Part no.	Designation	Article	Description
	50144900	MD 798i-11-82/L5-2222	IO-Link master	Type: IO-Link master Current consumption, max.: 11,000 mA Switching outputs for each sensor connection: 1 Piece(s) Switching output: Transistor, PNP Interface: IO-Link, Automatic protocol detection, EtherNet IP, Modbus TCP, PROFINET Connections: 12 Piece(s) Sensor connections: 8 Piece(s) Connections for voltage supply: 2 Piece(s) Interface connections: 2 Piece(s) Degree of protection: IP 67, IP 65, IP 69K

### Connection technology - Connection cables

	Part no.	Designation	Article	Description
	50135128	KD S-M12-8A-P1-050	Connection cable	Connection 1: Connector, M12, Axial, Female, A-coded, 8 -pin Connector, LED: No Connection 2: Open end Shielded: Yes Cable length: 5.000 mm Sheathing material: PUR

### Connection technology - Interconnection cables

	Part no.	Designation	Article	Description
	50129781	KDS DN-M12-5A-M12-5A-P3-050	Interconnection cable	Suitable for interface: DeviceNet, CANopen Connection 1: Connector, M12, Axial, Female, A-coded, 5 -pin Connection 2: Connector, M12, Axial, Male, A-coded, 5 -pin Shielded: Yes Cable length: 5,000 mm Sheathing material: PUR

## Accessories

### Mounting technology - Mounting brackets

	Part no.	Designation	Article	Description
	50142900	BT 700M.5-2SET	Mounting device set	Design of mounting device: Bracket mounting Fastening, at system: Through-hole mounting, T slotted hole Mounting bracket, at device: Screw type, Sliding block Type of mounting device: Rigid Material: Steel

### Configuration devices

	Part no.	Designation	Article	Description
	50121098	SET MD12-US2-IL1.1 + Zub.	Diagnostics set	Interface: USB Connections: 2 Piece(s) Degree of protection: IP 20

### Services

	Part no.	Designation	Article	Description
	S981001	CS10-S-110	Start-up support	Details: Performed at location of customer's choosing, duration: max. 10 hours. Conditions: Devices and connection cables are already mounted, price not including travel costs and, if applicable, accommodation expenses.
	S981005	CS10-T-110	Product training	Details: Location and content to be agreed upon, duration: max. 10 hours. Conditions: Price not including travel costs and, if applicable, accommodation expenses.

#### Note



A list with all available accessories can be found on the Leuze website in the Download tab of the article detailed page.