

Technical data sheet

Throughbeam photoelectric sensor receiver

Part no.: 50154156

LE28/PX-M12



For illustration purposes only

Contents

- Technical data
- Dimensioned drawings
- Electrical connection
- Diagrams
- Operation and display
- Suitable transmitters
- Part number code
- Notes
- Further information
- Accessories



Technical data

Basic data

| | |
|---------------------|-----------------------|
| Series | 28 |
| Operating principle | Throughbeam principle |
| Device type | Receiver |

Optical data

| | |
|-----------------------|----------------------------|
| Operating range | 0 ... 10 m |
| Operating range | Guaranteed operating range |
| Operating range limit | 0 ... 15 m |
| Operating range limit | Typical operating range |

Electrical data

| | |
|--------------------|------------------------------|
| Protective circuit | Polarity reversal protection |
| | Short circuit protected |

Performance data

| | |
|----------------------|--|
| Supply voltage U_B | 10 ... 30 V, DC, Incl. residual ripple |
| Residual ripple | 0 ... 15 %, From U_B |
| Open-circuit current | 0 ... 15 mA |

Outputs

| | |
|-------------------------------------|------------|
| Number of digital switching outputs | 1 Piece(s) |
|-------------------------------------|------------|

Switching outputs

| | |
|-------------------------|--------------------------|
| Voltage type | DC |
| Switching current, max. | 100 mA |
| Switching voltage | high: $\geq(U_B - 2.5V)$ |
| | low: $\leq 2.5 V$ |

Switching output 1

| | |
|---------------------|---------------------|
| Assignment | Connection 1, pin 4 |
| Switching element | Transistor, PNP |
| Switching principle | Dark switching |

Time behavior

| | |
|---------------------|--------|
| Switching frequency | 500 Hz |
| Response time | 1 ms |
| Readiness delay | 300 ms |

Connection

Connection 1

| | |
|--------------------|----------------|
| Function | Signal OUT |
| | Voltage supply |
| Type of connection | Connector |
| Thread size | M12 |
| Type | Male |
| Material | Plastic |
| No. of pins | 4 -pin |
| Encoding | A-coded |

Mechanical data

| | |
|-----------------------|---------------------------|
| Dimension (W x H x L) | 15 mm x 46.5 mm x 31.8 mm |
| Thread size | M18 |
| Housing material | Plastic |
| Plastic housing | ABS |
| Lens cover material | Plastic |
| Net weight | 75 g |
| Housing color | Black |
| | Red |

Operation and display

| | |
|-----------------|------------|
| Type of display | LED |
| Number of LEDs | 2 Piece(s) |

Environmental data

| | |
|--------------------------------|---------------|
| Ambient temperature, operation | -40 ... 60 °C |
| Ambient temperature, storage | -40 ... 70 °C |

Certifications

| | |
|----------------------|---------------|
| Degree of protection | IP 67 |
| Protection class | III |
| Approvals | c UL US |
| Standards applied | IEC 60947-5-2 |

Classification

| | |
|-----------------------|----------|
| Customs tariff number | 85365019 |
| ECLASS 5.1.4 | 27270901 |
| ECLASS 8.0 | 27270901 |
| ECLASS 9.0 | 27270901 |
| ECLASS 10.0 | 27270901 |
| ECLASS 11.0 | 27270901 |
| ECLASS 12.0 | 27270901 |
| ECLASS 13.0 | 27270901 |
| ECLASS 14.0 | 27270901 |
| ECLASS 15.0 | 27270901 |
| ETIM 5.0 | EC002716 |
| ETIM 6.0 | EC002716 |
| ETIM 7.0 | EC002716 |
| ETIM 8.0 | EC002716 |
| ETIM 9.0 | EC002716 |
| ETIM 10.0 | EC002716 |

Dimensioned drawings

All dimensions in millimeters

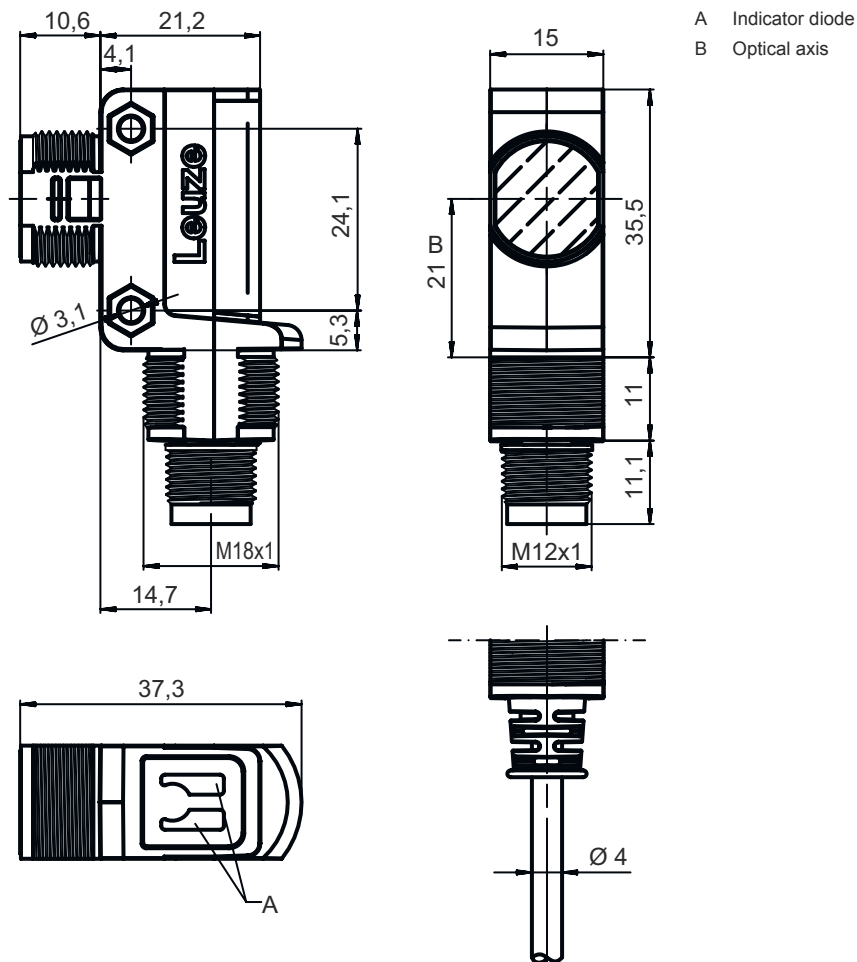

Electrical connection

Connection 1

| | |
|--------------------|----------------|
| Function | Signal OUT |
| | Voltage supply |
| Type of connection | Connector |
| Thread size | M12 |
| Type | Male |
| Material | Plastic |
| No. of pins | 4 -pin |
| Encoding | A-coded |

Pin Pin assignment

| | |
|---|-------|
| 1 | V+ |
| 2 | n.c. |
| 3 | GND |
| 4 | OUT 1 |

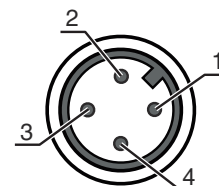

Diagrams

Typ. response behavior

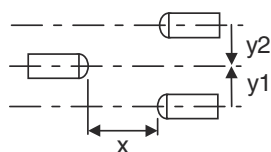
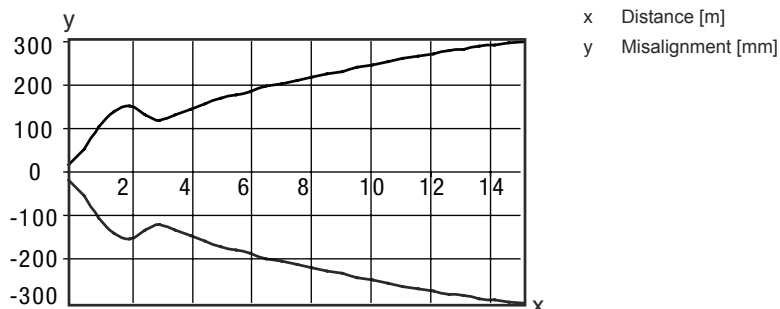

Operation and display

| LED | Display | Meaning |
|-----|--------------------------|-----------------------|
| 1 | Green, continuous light | Operational readiness |
| 2 | Yellow, continuous light | Light path free |
| | Yellow, flashing | No function reserve |

Suitable transmitters

| | Part no. | Designation | Article | Description |
|---|----------|-------------|--|--|
|  | 50117928 | LS28/9D-M12 | Throughbeam photoelectric sensor transmitter | Special version: Deactivation input Operating range limit: 0 ... 15 m Light source: LED, Red Supply voltage: DC Deactivation inputs: 2 Piece(s) Connection: Connector, M12, Plastic, 4 -pin |

Part number code

Part designation: AAA28D-E.F/GG-HH

| | |
|--------------|---|
| AAA28 | Operating principle / construction LS28: throughbeam photoelectric sensor transmitter LE28: throughbeam photoelectric sensor receiver ET28: energetic diffuse reflection sensor FT28: diffuse reflection sensor with fading PRK28: retro-reflective photoelectric sensor with polarization filter |
| d | Light type n/a: red light l: infrared light |
| E | Preset range (optional) n/a: operating range acc. to data sheet xxxF: Preset range [mm] |
| F | Equipment 3: teach-in via button |

Part number code

| | |
|-----------|--|
| GG | Switching output / function (OUT1 = pin 4, OUT2 = pin 2): 2: NPN transistor output, light switching N: NPN transistor output, dark switching 4: PNP transistor output, light switching P: PNP transistor output, dark switching 9: deactivation input (deactivation with high signal) D: Input for transmitter deactivation (deactivation with LOW signal) X: pin not used |
| HH | Electrical connection n/a: cable, standard length 2000 mm, 4-wire 200-M8: cable, length 200 mm with M8 connector, 4-pin, axial (plug) 200-M12: cable, length 200 mm with M12 connector, 4-pin, axial (plug) |

Note

| | |
|--|--|
|  | ⓘ A list with all available device types can be found on the Leuze website at www.leuze.com . |
|--|--|

Notes

Observe intended use!

| | |
|---|---|
|  | ⓘ This product is not a safety sensor and is not intended as personnel protection. ⓘ The product may only be put into operation by competent persons. ⓘ Only use the product in accordance with its intended use. |
|---|---|

For UL applications:

| | |
|--|---|
|  | ⓘ For UL applications, use is only permitted in Class 2 circuits in accordance with the NEC (National Electric Code). ⓘ These proximity switches shall be used with UL Listed Cable assemblies rated 30V, 0.5A min, in the field installation, or equivalent (categories: CYJV/ CYJV7 or PVVA/PVVA7) |
|--|---|

Further information

- Sum of the output currents for both outputs, 50 mA for ambient temperatures > 40 °C

Accessories

Connection technology - Connection cables

| | Part no. | Designation | Article | Description |
|--|----------|--------------------|------------------|---|
|  | 50130652 | KD U-M12-4A-V1-050 | Connection cable | Connection 1: Connector, M12, Axial, Female, A-coded, 4 -pin Connector, LED: No Connection 2: Open end Shielded: No Cable length: 5.000 mm Sheathing material: PVC |



Accessories

| | Part no. | Designation | Article | Description |
|--|----------|--------------------|------------------|--|
|  | 50130690 | KD U-M12-4W-V1-050 | Connection cable | Connection 1: Connector, M12, Angled, Female, A-coded, 4 -pin Connector, LED: No Connection 2: Open end Shielded: No Cable length: 5.000 mm Sheathing material: PVC |

Mounting technology - Mounting brackets

| | Part no. | Designation | Article | Description |
|--|----------|---------------|---------------------|--|
|  | 50124651 | BT 205M-10SET | Mounting device set | Design of mounting device: Angle, L-shape Fastening, at system: Through-hole mounting Mounting bracket, at device: Screw type Type of mounting device: Rigid Material: Metal |

Mounting technology - Rod mounts

| | Part no. | Designation | Article | Description |
|--|----------|--------------|-----------------|--|
|  | 50117255 | BTU 200M-D12 | Mounting system | Design of mounting device: Mounting system Fastening, at system: For 12 mm rod, Sheet-metal mounting Mounting bracket, at device: Screw type, Suited for M3 screws Type of mounting device: Clampable, Adjustable, Turning, 360° Material: Metal |
|  | 50117490 | BTU D18M-D12 | Mounting system | Design of mounting device: Mounting system Fastening, at system: Through-hole mounting Mounting bracket, at device: Screw type Type of mounting device: Clampable, Adjustable, Turning, 360° Material: Metal |

Note



A list with all available accessories can be found on the Leuze website in the Download tab of the article detailed page.