

## Technical data sheet

### Safety transponder

Part no.: 63002000

RD800-SSCA-M12R

#### Contents

- Technical data
- Dimensioned drawings
- Electrical connection
- Circuit diagrams
- Diagrams
- Notes
- Accessories



For illustration purposes only



## Technical data

### Basic data

Series	RD800
Application	Individual use
Code type	Standard code

### Characteristic parameters

SIL	Up to 3, IEC 61508
SILCL	Up to 3, IEC/EN 62061
Performance Level (PL)	Up to and including e, EN ISO 13849-1
MTTF <sub>d</sub>	4,077 years, EN ISO 13849-1
PFH <sub>D</sub>	1.45E-09 per hour
Mission time T <sub>M</sub>	20 years, EN ISO 13849-1
Category	Up to and including 4, EN ISO 13849
DC	High

### Electrical data

Protective circuit	Cross circuit protection
	Short circuit protected
Pulse resistance	1,500 V
Usage category at DC 12	Ue 24 V, Ie 0.25 A, EN 60947-5-1

#### Performance data

Supply voltage U <sub>B</sub>	24 V, DC, -15 ... 10 %
Current consumption, max.	250 mA
Power consumption, max.	1 W
Nominal current, min.	0.5 mA
Overvoltage category	III
Fuse, external	1 A
Fuse, internal	0.75 A polyfuse (O1 + O2 + O3)
Rated insulation voltage	32 V DC
Conventional thermal current, max.	0.25 A

#### Outputs

Number of safety-related switching outputs (OSSDs)	2 Piece(s)
Number of digital switching outputs	1 Piece(s)
Switching power, max.	6 W

#### Safety-related switching outputs

Type	Safety-related switching output OSSD
Switching voltage, typ.	24 V
Voltage type	DC
Test-pulse length, max.	0.3 ms
Output current, max.	250 mA
Capacitance, max. between an output and GND	200 nF
Capacitance, max. between two outputs	200 nF

#### Safety-related switching output 1

Switching element	Transistor, PNP
-------------------	-----------------

#### Safety-related switching output 2

Switching element	Transistor, PNP
-------------------	-----------------

#### Switching outputs

Type	Digital switching output
Switching voltage, typ.	24 V
Voltage type	DC
Switching current, max.	100 mA

### Switching output 1

Switching element	Transistor, PNP
Function	Signal output

### Time behavior

Reaction time after removing the actuator, min.	80 ms
Reaction time after removing the actuator, max.	150 ms
Reaction time after shutdown, input, min.	7 ms
Reaction time after shutdown, input, max.	12 ms

### Connection

Number of connections	1 Piece(s)
-----------------------	------------

#### Connection 1

Function	Connection with PLC
	Signal OUT
	Voltage supply
Type of connection	Connector
Thread size	M12
Material	Metal
No. of pins	5 -pin
Plug outlet	On right side

#### Cable properties

Length of connection cable, max.	50 m
----------------------------------	------

### Mechanical data

Design	Cubic
Dimension (W x H x L)	25 mm x 18 mm x 72 mm
Housing material	Plastic
Plastic housing	PA 66
Net weight	57 g
Housing color	Black
Type of fastening	Through-hole mounting
Switching hysteresis, max.	2.4 mm
Assured cut-out distance (S <sub>ar</sub> ), min.	16 mm
Assured cut-in distance (S <sub>ao</sub> ), max.	10 mm
Nominal switch-off distance, max.	14 mm
Nominal operating distance, max.	12 mm
Distance between two systems (sensor, actuator), min.	50 mm
Repeatability, max.	1.2 mm
Screw tightening torque	0.8 ... 2 N·m

### Operation and display

Type of display	LED
Number of LEDs	4 Piece(s)

### Environmental data

Ambient temperature, operation	-25 ... 70 °C
Ambient temperature, storage	-25 ... 85 °C
Degree of contamination	3, EN 60947-1

## Technical data

### Certifications

Degree of protection	IP 67
	IP 69K
Certifications	c UL US
	TÜV Süd
Test procedure for shock in accordance with standard	EN 60068-2-27
Test procedure for vibration in accordance with standard	EN 60068-2-6

### Classification

Customs tariff number	85369095
ECLASS 5.1.4	27272403
ECLASS 8.0	27272403
ECLASS 9.0	27272403
ECLASS 10.0	27272403
ECLASS 11.0	27272403
ECLASS 12.0	27274601
ECLASS 13.0	27274601
ECLASS 14.0	27274601
ETIM 5.0	EC001829
ETIM 6.0	EC001829
ETIM 7.0	EC001829
ETIM 8.0	EC001829
ETIM 9.0	EC001829

## Dimensioned drawings

All dimensions in millimeters

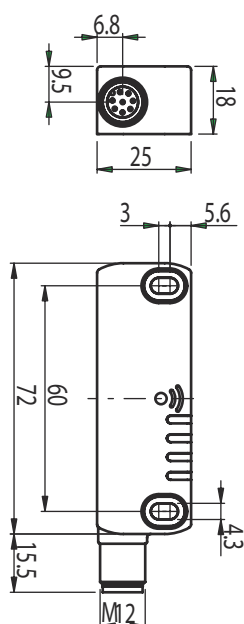

## Dimensioned drawings

Minimum distance in mm

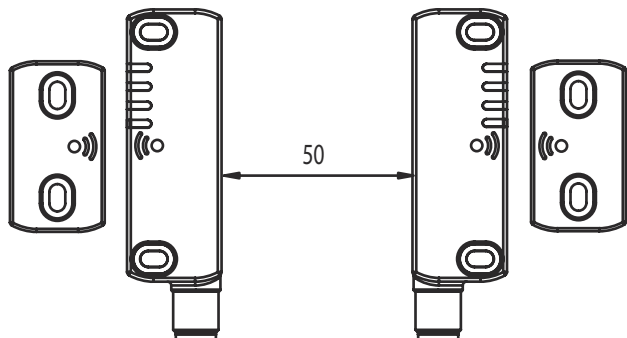

Fastening



## Electrical connection

### Connection 1

<b>Function</b>	Connection with PLC Signal OUT Voltage supply
<b>Type of connection</b>	Connector
<b>Thread size</b>	M12
<b>Type</b>	Male
<b>Material</b>	Metal
<b>No. of pins</b>	5 -pin
<b>Encoding</b>	A-coded
<b>Plug outlet</b>	On right side

Pin	Pin assignment
1	A1
2	OS1
3	A2
4	OS2
5	O3

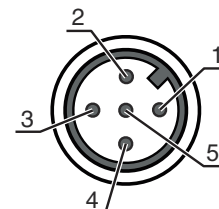

# Circuit diagrams

## Internal circuit diagram



## Diagrams

### Safety-related distances

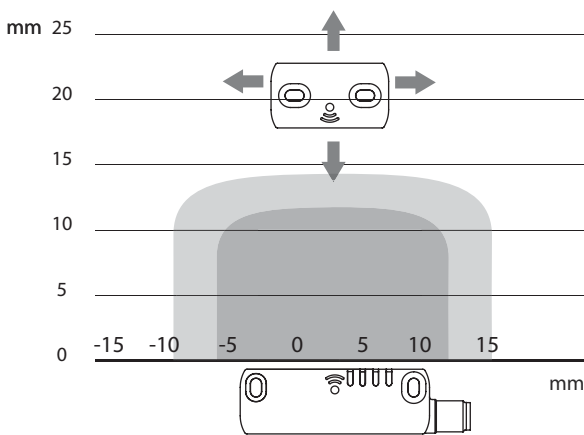

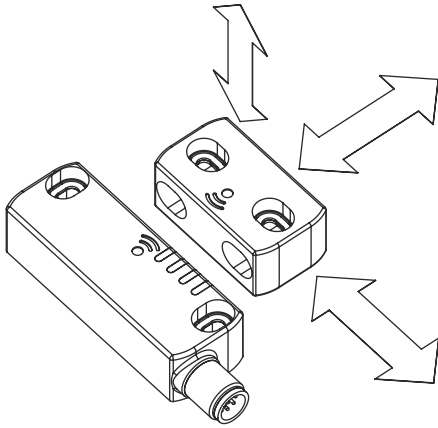

# Diagrams

## Approach directions







## Notes

 <b>Observe intended use!</b>	
	<ul style="list-style-type: none"> <li>↪ The product may only be put into operation by competent persons.</li> <li>↪ Only use the product in accordance with its intended use.</li> </ul>

## Accessories

### Connection technology - Connection cables

	Part no.	Designation	Article	Description
  	50133860	KD S-M12-5A-P1-050	Connection cable	Connection 1: Connector, M12, Axial, Female, A-coded, 5 -pin Connector, LED: No Connection 2: Open end Shielded: Yes Cable length: 5.000 mm Sheathing material: PUR

<b>Note</b>	
	↪ A list with all available accessories can be found on the Leuze website in the Download tab of the article detailed page.