

## Technical data sheet

### Throughbeam photoelectric sensor transmitter

Part no.: 50137195

LS3CL1.B/XX-M8



For illustration purposes only

#### Contents

- Technical data
- Dimensioned drawings
- Electrical connection
- Diagrams
- Operation and display
- Suitable receivers
- Part number code
- Notes
- Further information
- Accessories



## Technical data

### Basic data

|                     |                       |
|---------------------|-----------------------|
| Series              | 3C                    |
| Operating principle | Throughbeam principle |
| Device type         | Transmitter           |

### Optical data

|                                      |  |
|--------------------------------------|--|
| Operating range                      | 0 ... 5 m  |
| Operating range                      | Guaranteed operating range                               |
| Operating range limit                | Typical operating range                                  |
| Operating range limit                | 0 ... 10 m   |
| Beam path                            | Collimated   |
| Light source                         | Laser, Red   |
| Wavelength                           | 650 nm   |
| Laser class                          | 1, in accordance with IEC 60825-1:2014 (EN 60825-1:2014) |
| Transmitted-signal shape             | Pulsed   |
| Light spot size [at sensor distance] | 2.5 mm x 2 mm [1,000 mm]                                 |
| Type of light spot geometry          | elliptic   |

### Electrical data

|                    |   |
|--------------------|---|
| Protective circuit | Polarity reversal protection<br>Short circuit protected |
|--------------------|---|

#### Performance data

|                      |  |
|----------------------|--|
| Supply voltage $U_B$ | 10 ... 30 V, DC, Incl. residual ripple |
| Residual ripple      | 0 ... 15 %, From $U_B$                 |
| Open-circuit current | 0 ... 20 mA                            |

### Time behavior

|                 |        |
|-----------------|--------|
| Readiness delay | 300 ms |
|-----------------|--------|

### Connection

#### Connection 1

|                    |                |
|--------------------|----------------|
| Function           | Voltage supply |
| Type of connection | Connector      |
| Thread size        | M8             |
| Type               | Male           |
| Material           | Metal          |
| No. of pins        | 4 -pin         |

### Mechanical data

|                            |   |
|----------------------------|---|
| Dimension (W x H x L)      | 11.4 mm x 34.2 mm x 18.3 mm                             |
| Housing material           | Plastic   |
| Plastic housing            | PC-ABS  |
| Lens cover material        | Plastic / PMMA  |
| Net weight                 | 10 g  |
| Housing color              | Red   |
| Type of fastening          | Two M3 threaded sleeves<br>Via optional mounting device |
| Compatibility of materials | ECOLAB  |

### Operation and display

|                 |            |
|-----------------|------------|
| Type of display | LED        |
| Number of LEDs  | 2 Piece(s) |

### Environmental data

|                                |               |
|--------------------------------|---------------|
| Ambient temperature, operation | -40 ... 55 °C |
| Ambient temperature, storage   | -40 ... 70 °C |

### Certifications

|                      |                 |
|----------------------|-----------------|
| Degree of protection | IP 67<br>IP 69K |
| Protection class     | III             |
| Certifications       | c UL US         |
| Standards applied    | IEC 60947-5-2   |

### Classification

|                       |          |
|-----------------------|----------|
| Customs tariff number | 85365019 |
| ECLASS 5.1.4          | 27270901 |
| ECLASS 8.0            | 27270901 |
| ECLASS 9.0            | 27270901 |
| ECLASS 10.0           | 27270901 |
| ECLASS 11.0           | 27270901 |
| ECLASS 12.0           | 27270901 |
| ECLASS 13.0           | 27270901 |
| ECLASS 14.0           | 27270901 |
| ETIM 5.0              | EC002716 |
| ETIM 6.0              | EC002716 |
| ETIM 7.0              | EC002716 |
| ETIM 8.0              | EC002716 |
| ETIM 9.0              | EC002716 |

# Dimensioned drawings

All dimensions in millimeters

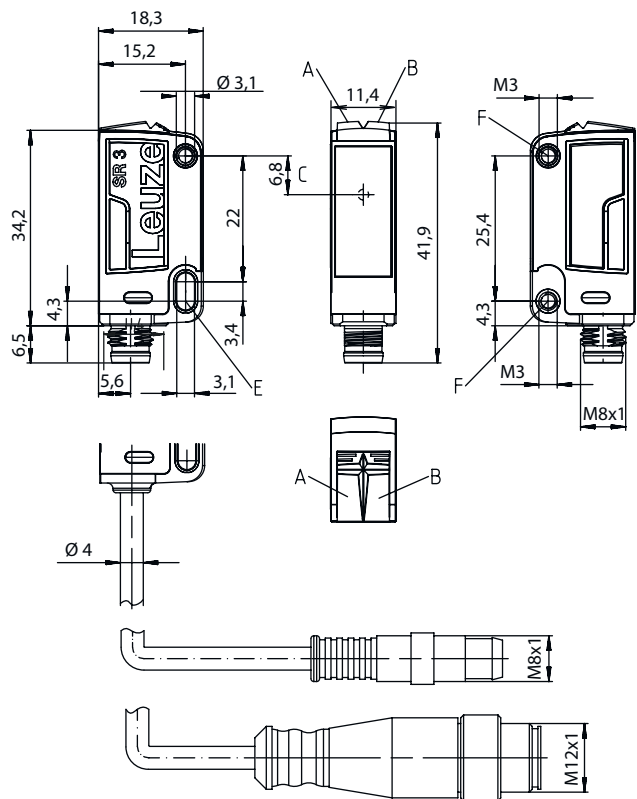

- A Green LED
- B Yellow LED
- C Optical axis
- E Mounting sleeve (standard)
- F Threaded sleeve (3C.B series)

## Electrical connection

### Connection 1

|                    |                |
|--------------------|----------------|
| Function           | Voltage supply |
| Type of connection | Connector      |
| Thread size        | M8             |
| Type               | Male           |
| Material           | Metal          |
| No. of pins        | 4 -pin         |

### Pin Pin assignment

|   |      |
|---|------|
| 1 | V+   |
| 2 | n.c. |
| 3 | GND  |
| 4 | n.c. |

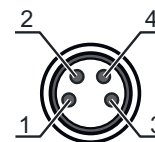

# Diagrams

Typ. light spot size

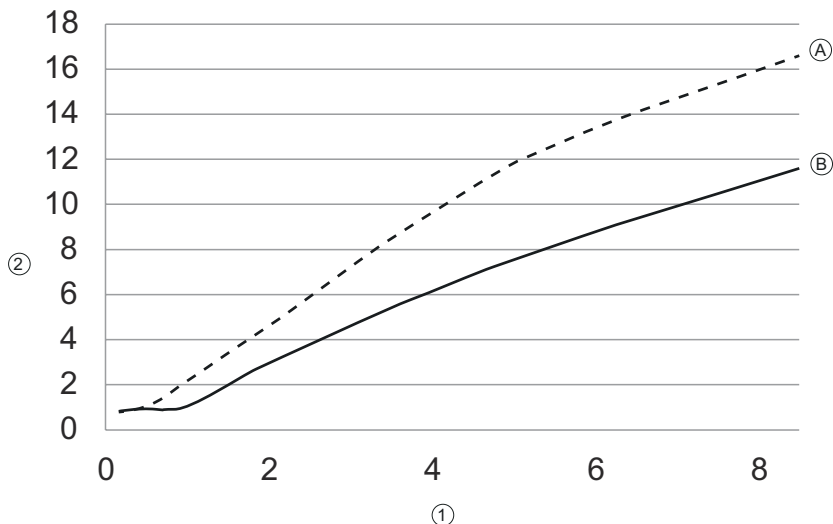



- x Distance [m]
- y Diameter [mm]
- 1 Distance [m]      A Vertical
- 2 Diameter [mm]    B Horizontal

## Operation and display

| LED | Display                  | Meaning                 |
|-----|--------------------------|-------------------------|
| 1   | Green, continuous light  | Operational readiness   |
| 2   | Yellow, continuous light | Transmitted beam active |

## Suitable receivers

|   | Part no. | Designation     | Article                                   | Description   |
|---|----------|-----------------|---|---|
|  | 50137206 | LE3CL1.B1/4W-M8 | Throughbeam photoelectric sensor receiver | Special version: Warning output<br>Operating range limit: 0 ... 10 m<br>Supply voltage: DC<br>Digital switching outputs: 2 Piece(s)<br>Switching output 1: Transistor, PNP, Light switching<br>Switching output 2: Transistor, PNP, UB switching<br>Switching frequency: 3,000 Hz<br>Connection: Connector, M8, Metal, 4 -pin<br>Operational controls: 270° potentiometer                                   |
|  | 50137202 | LE3CL1.B1/6G-M8 | Throughbeam photoelectric sensor receiver | Operating range limit: 0 ... 10 m<br>Supply voltage: DC<br>Digital switching outputs: 2 Piece(s)<br>Switching output 1: Transistor, Push-pull, Light switching (PNP)/dark switching (NPN)<br>Switching output 2: Transistor, Push-pull, Dark switching (PNP)/light switching (NPN)<br>Switching frequency: 3,000 Hz<br>Connection: Connector, M8, Metal, 4 -pin<br>Operational controls: 270° potentiometer |

## Part number code

Part designation: AAA 3C d EE-f.GG H/i J-K

|              |  |
|--------------|--|
| <b>AAA3C</b> | <b>Operating principle / construction</b><br>HT3C: Diffuse reflection sensor with background suppression<br>LS3C: Throughbeam photoelectric sensor transmitter<br>LE3C: Throughbeam photoelectric sensor receiver<br>PRK3C: Retro-reflective photoelectric sensor with polarization filter<br>ODT3C: Distance diffuse sensor with background suppression   |
| <b>d</b>     | <b>Light type</b><br>n/a: red light<br>I: infrared light   |
| <b>EE</b>    | <b>Light source</b><br>n/a: LED<br>L1: laser class 1<br>L2: laser class 2  |
| <b>f</b>     | <b>Preset range (optional)</b><br>n/a: operating range acc. to data sheet<br>xxxF: Preset range [mm]<br>2M: operating range of 2 meters  |
| <b>GG</b>    | <b>Equipment</b><br>n/a: standard<br>A: Autocollimation principle (single lens) for positioning tasks<br>B: Housing model with two M3 threaded sleeves, brass<br>F: Permanently set range<br>L: Long light spot<br>S: small light spot<br>T: autocollimation principle (single lens) for highly transparent bottles without tracking<br>TT: autocollimation principle (single lens) for highly transparent bottles with tracking<br>V: V-optics<br>XL: Extra long light spot<br>X: extended model<br>HF: Suppression of HF illumination (LED)  |
| <b>H</b>     | <b>Operating range adjustment</b><br>n/a with HT: range adjustable via 8-turn potentiometer<br>n/a with retro-reflective photoelectric sensors (PRK): operating range not adjustable<br>1: 270° potentiometer<br>3: teach-in via button<br>6: auto-teach   |
| <b>i</b>     | <b>Switching output/function OUT 1/IN: Pin 4 or black conductor</b><br>2: NPN transistor output, light switching<br>N: NPN transistor output, dark switching<br>4: PNP transistor output, light switching<br>P: PNP transistor output, dark switching<br>6: push-pull switching output, PNP light switching, NPN dark switching<br>G: Push-pull switching output, PNP dark switching, NPN light switching<br>L: IO-Link interface (SIO mode: PNP light switching, NPN dark switching)<br>8: activation input (activation with high signal)<br>X: pin not used<br>1: IO-Link / light switching (NPN) / dark switching (PNP) |
| <b>J</b>     | <b>Switching output / function OUT 2/IN: pin 2 or white conductor</b><br>2: NPN transistor output, light switching<br>N: NPN transistor output, dark switching<br>4: PNP transistor output, light switching<br>P: PNP transistor output, dark switching<br>6: push-pull switching output, PNP light switching, NPN dark switching<br>G: Push-pull switching output, PNP dark switching, NPN light switching<br>W: warning output<br>X: pin not used<br>8: activation input (activation with high signal)<br>9: deactivation input (deactivation with high signal)<br>T: teach-in via cable                                 |
| <b>K</b>     | <b>Electrical connection</b><br>n/a: cable, standard length 2000 mm, 4-wire<br>5000: cable, standard length 5000 mm, 4-wire<br>M8: M8 connector, 4-pin (plug)<br>M8.3: M8 connector, 3-pin (plug)<br>200-M8: cable, length 200 mm with M8 connector, 4-pin, axial (plug)<br>200-M8.3: cable, length 200 mm with M8 connector, 3-pin, axial (plug)<br>200-M12: cable, length 200 mm with M12 connector, 4-pin, axial (plug)   |

### Note



A list with all available device types can be found on the Leuze website at [www.leuze.com](http://www.leuze.com).

## Notes

**Observe intended use!**

This product is not a safety sensor and is not intended as personnel protection.

The product may only be put into operation by competent persons.

Only use the product in accordance with its intended use.

**For UL applications:**

For UL applications, use is only permitted in Class 2 circuits in accordance with the NEC (National Electric Code).

These proximity switches shall be used with UL Listed Cable assemblies rated 30V, 0.5A min, in the field installation, or equivalent (categories: CYJV/ CYJV7 or PVVA/PVVA7)

**WARNING! LASER RADIATION – CLASS 1 LASER PRODUCT**

The device satisfies the requirements of IEC/EN 60825-1:2014 safety regulations for a product of **laser class 1** and complies with 21 CFR 1040.10 except for conformance with IEC 60825-1 Ed. 3., as described in Laser Notice No. 56, dated May 8, 2019.

Observe the applicable statutory and local laser protection regulations.

The device must not be tampered with and must not be changed in any way. There are no user-serviceable parts inside the device. Repairs must only be performed by Leuze electronic GmbH + Co. KG.

## Further information

- Light source: Average life expectancy 50,000h at an ambient temperature of 25°C

## Accessories

### Connection technology - Connection cables



|  | Part no. | Designation       | Article          | Description  |
|--|----------|-------------------|------------------|--|
|  | 50130850 | KD U-M8-4A-V1-050 | Connection cable | Connection 1: Connector, M8, Axial, Female, 4 -pin<br>Connector, LED: No<br>Connection 2: Open end<br>Shielded: No<br>Cable length: 5.000 mm<br>Sheathing material: PVC  |
|  | 50130871 | KD U-M8-4W-V1-050 | Connection cable | Connection 1: Connector, M8, Angled, Female, 4 -pin<br>Connector, LED: No<br>Connection 2: Open end<br>Shielded: No<br>Cable length: 5.000 mm<br>Sheathing material: PVC |

## Accessories

### Mounting technology - Mounting brackets

|   | Part no. | Designation | Article         | Description   |
|---|----------|-------------|-----------------|---|
|  | 50139831 | BT 205M     | Mounting device | Fastening, at system: Through-hole mounting<br>Mounting bracket, at device: Screw type<br>Type of mounting device: Rigid<br>Material: Metal |

### Mounting technology - Rod mounts

|  | Part no. | Designation  | Article         | Description  |
|--|----------|--------------|-----------------|--|
|   | 50117829 | BTP 200M-D12 | Mounting system | Design of mounting device: Protection hood<br>Fastening, at system: For 12 mm rod<br>Mounting bracket, at device: Screw type<br>Type of mounting device: Clampable, Adjustable, Turning, 360°<br>Material: Metal   |
|  | 50117255 | BTU 200M-D12 | Mounting system | Design of mounting device: Mounting system<br>Fastening, at system: For 12 mm rod, Sheet-metal mounting<br>Mounting bracket, at device: Screw type, Suited for M3 screws<br>Type of mounting device: Clampable, Adjustable, Turning, 360°<br>Material: Metal |

#### Note



A list with all available accessories can be found on the Leuze website in the Download tab of the article detailed page.