

Technical data sheet

Ultrasonic sensor

Part no.: 50149542

HTU218-1500/PT-M12

Contents

- Technical data
- Dimensioned drawings
- Electrical connection
- Diagrams
- Operation and display
- Part number code
- Notes
- Accessories



For illustration purposes only



Technical data

Basic data

Series	200
Operating principle	Diffuse reflection principle with background suppression
Contains	2x M18 mounting nut

Special version

Special version	Teach input
-----------------	-------------

Characteristic parameters

MTTF	677 years
------	-----------

Ultrasonic specifications

Operating range	0.15 ... 1.5 m
Operating range	Guaranteed operating range
Ultrasonic frequency	200 kHz
Shape of sound lobe	standard
Direction of beam	Front
Opening angle	16 °
Adjustment range	150 ... 1,500 mm

Measurement data

Resolution	1.0 mm
Repeatability	0.07 %
Reference value repeatability	End value
Temperature drift	0.2 %/K

Electrical data

Protective circuit	Polarity reversal protection Short circuit protected
--------------------	---

Performance data

Supply voltage U_B	18 ... 30 V, DC
Residual ripple	0 ... 10 %, From U_B
Open-circuit current	0 ... 40 mA
Switching hysteresis	2 mm

Inputs

Number of teach inputs	1 Piece(s)
------------------------	------------

Teach inputs

Voltage type	DC
Switching voltage	high: $\geq 9V$ low: $\leq 2 V$

Teach input 1

Active switching state	High
------------------------	------

Outputs

Number of digital switching outputs	1 Piece(s)
-------------------------------------	------------

Switching outputs

Voltage type	DC
Switching current, max.	150 mA
Switching voltage	low: $\leq 2 V$

Switching output 1

Switching element	Transistor, PNP
Switching principle	Dark switching

Time behavior

Switching frequency	5 Hz
Response time	100 ms
Readiness delay	300 ms

Connection

Number of connections	1 Piece(s)
-----------------------	------------

Connection 1

Function	Signal OUT Teach input Voltage supply
Type of connection	Connector
Thread size	M12
Type	Male
Material	Metal
No. of pins	4 -pin
Encoding	A-coded

Mechanical data

Design	Cylindrical
Thread size	M18 x 1 mm
Dimension (\varnothing x L)	18 mm x 55 mm
Housing material	Metal
Metal housing	Nickel-plated brass
Ultrasonic transducer material	Piezoceramics (contains lead zirconium titanate (PZT))
Net weight	30 g
Housing color	Silver

Operation and display

Type of display	LED
Number of LEDs	1 Piece(s)

Environmental data

Ambient temperature, operation	-25 ... 70 °C
Ambient temperature, storage	-25 ... 70 °C

Certifications

Degree of protection	IP 67
Protection class	III
Certifications	c UL US
Standards applied	IEC 60947-5-2

Classification

Customs tariff number	85365019
ECLASS 5.1.4	27272803
ECLASS 8.0	27272803
ECLASS 9.0	27272803
ECLASS 10.0	27272803
ECLASS 11.0	27272803
ECLASS 12.0	27272803
ECLASS 13.0	27272803
ECLASS 14.0	27272803
ETIM 5.0	EC001849
ETIM 6.0	EC001849
ETIM 7.0	EC001849
ETIM 8.0	EC001849
ETIM 9.0	EC001849

Dimensioned drawings

All dimensions in millimeters

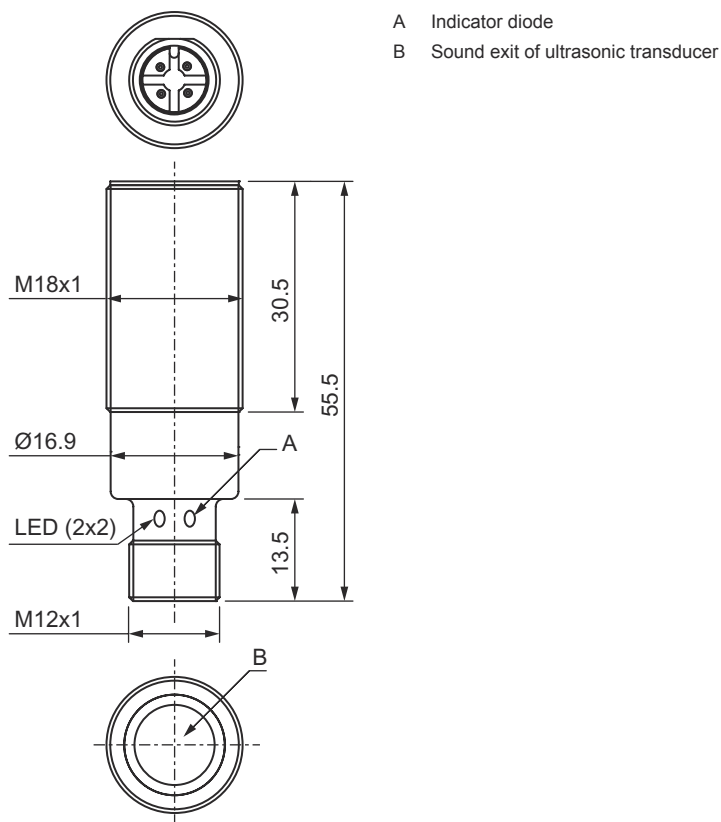

Electrical connection

Connection 1

Function	Signal OUT
	Teach input
	Voltage supply
Type of connection	Connector
Thread size	M12
Type	Male
Material	Metal
No. of pins	4 -pin
Encoding	A-coded

Pin	Pin assignment
1	V+
2	IN 1
3	GND
4	OUT 1

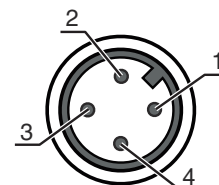

Diagrams

Typ. response behavior

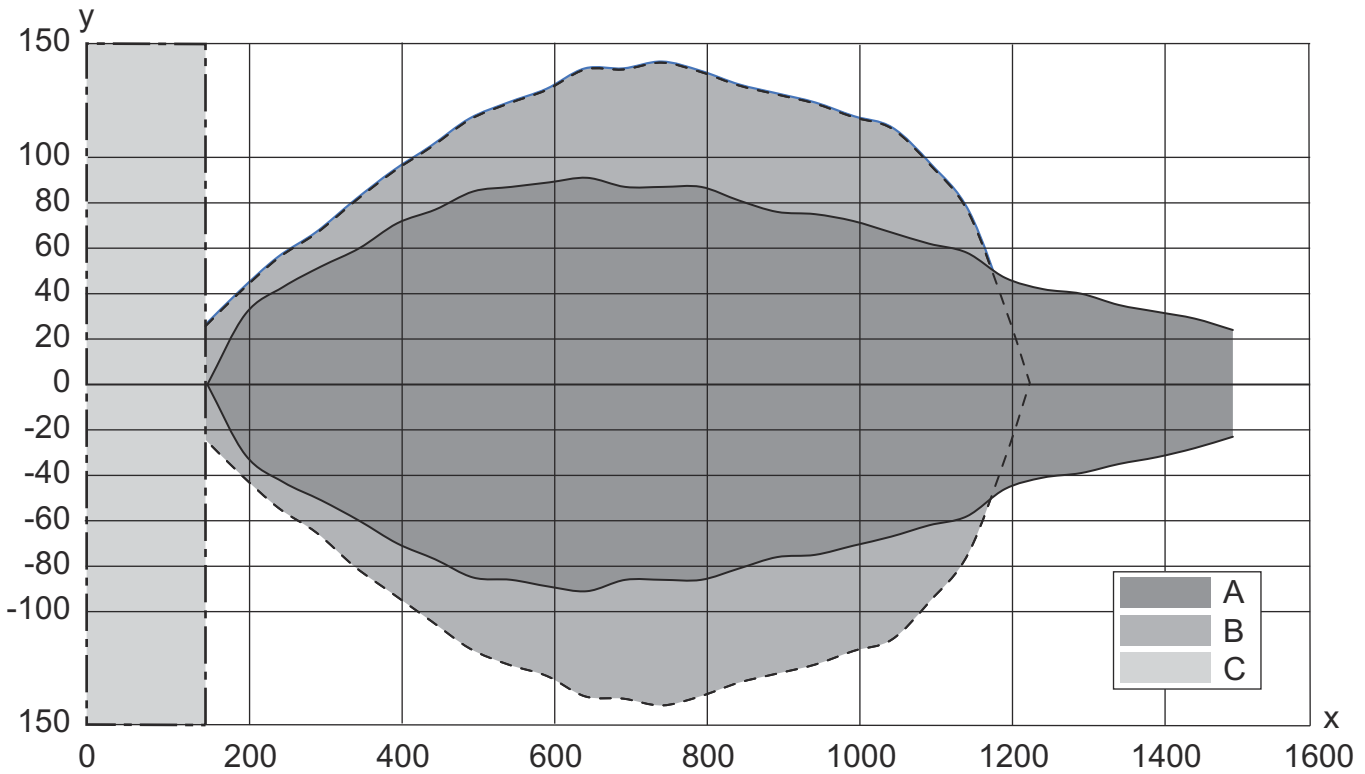

- x Object distance [mm]
- y Sound cone width [mm]
- A Plate 200 x 200 mm
- B Rod Ø 25 mm
- C Minimum distance in mm

Operation and display

LED	Display	Meaning
1	Yellow, continuous light	Operational readiness
	Green, continuous light	Switching output/switching state

Part number code

Part designation: AAA2BB-xxxx/CD-EE

AAA	Operating principle HTU: Ultrasonic sensor, scanning principle, with background suppression DMU: Ultrasonic sensor, distance measurement
2BB	Design 208: Cylindrical with M8 thread 212: Cylindrical with M12 thread 218: Cylindrical with M18 thread 230: Cylindrical with M30 thread
xxxx	Operating range Operating range in millimeters

Part number code

C	Switching output / function OUT 1/IN: Pin 4 2: NPN transistor output, light switching N: NPN transistor output, dark switching 4: PNP transistor output, light switching P: PNP transistor output, dark switching L: IO-Link
D	Switching output / function OUT 2/IN: pin 2 T: teach-in via cable A: Analog current output V: Analog voltage output
EE	Electrical connection M8: M8 connector, 4-pin (plug) M12: M12 connector, 4-pin (plug)

Note



A list with all available device types can be found on the Leuze website at www.leuze.com.

Notes



⚠ Observe intended use!



- This product is not a safety sensor and is not intended as personnel protection.
- The product may only be put into operation by competent persons.
- Only use the product in accordance with its intended use.

Accessories

Connection technology - Connection cables

	Part no.	Designation	Article	Description
	50130652	KD U-M12-4A-V1-050	Connection cable	Connection 1: Connector, M12, Axial, Female, A-coded, 4 -pin Connector, LED: No Connection 2: Open end Shielded: No Cable length: 5.000 mm Sheathing material: PVC
	50130690	KD U-M12-4W-V1-050	Connection cable	Connection 1: Connector, M12, Angled, Female, A-coded, 4 -pin Connector, LED: No Connection 2: Open end Shielded: No Cable length: 5.000 mm Sheathing material: PVC

Accessories

Mounting technology - Mounting brackets

	Part no.	Designation	Article	Description
	50113548	BT D18M.5	Mounting bracket	Diameter, inner: 18 mm Design of mounting device: Angle, L-shape Fastening, at system: Through-hole mounting Mounting bracket, at device: Screw type Type of mounting device: Rigid Material: Stainless steel

Mounting technology - Rod mounts

	Part no.	Designation	Article	Description
	50111501	MC 018K	Clamp	Diameter, inner: 18 mm Design of mounting device: Mounting clamp Fastening, at system: Through-hole mounting Mounting bracket, at device: Clampable Type of mounting device: Rigid Material: Plastic

General

	Part no.	Designation	Article	Description
	50149785	UA US90-M18	Deflector attachment	Type of article: Deflector attachment for ultrasonic sensors Thread size: M18 Diameter: 18 mm Length: 30 mm

Note



A list with all available accessories can be found on the Leuze website in the Download tab of the article detailed page.