

Technical data sheet Acknowledgment unit

Part no.: 50141871

AC-ABF11

Contents

- Technical data
- Dimensioned drawings
- Electrical connection
- Accessories



For illustration purposes only

Technical data

Electrical data

Contact allocation	NO(1)
Switching current via button	1 ... 1,000 mA
Current load, max.	10 A

Performance data

Current consumption, max.	5 ... 20 mA
Rated insulation voltage	500 V AC/DC

Connection

Number of connections	1 Piece(s)
-----------------------	------------

Connection 1

Type of connection	Connector
Thread size	M12
Type	Male
Material	Plastic
No. of pins	4 -pin

Mechanical data

Dimension (W x H x L)	72 mm x 56 mm x 80 mm
Plastic housing	Glass fiber reinforced (PPS), self-extinguishing
Net weight	250 g
Housing color	Black Gray
Clamping plate material	Stainless steel

Operation and display

Type of display	Continuous light LED
Operational controls	1 command device (pushbutton blue)

Environmental data

Ambient temperature, operation	-25 ... 70 °C
Ambient temperature, storage	-25 ... 70 °C

Certifications

Degree of protection	IP 67 IP 69K
Protection class	III

Classification

Customs tariff number	85369095
ECLASS 5.1.4	27279290
ECLASS 8.0	27279290
ECLASS 9.0	27279090
ECLASS 10.0	27371246
ECLASS 11.0	27371246
ECLASS 12.0	27371246
ECLASS 13.0	27371246
ECLASS 14.0	27371246
ETIM 5.0	EC002498
ETIM 6.0	EC003015
ETIM 7.0	EC003015
ETIM 8.0	EC003015
ETIM 9.0	EC003015

Dimensioned drawings

All dimensions in millimeters

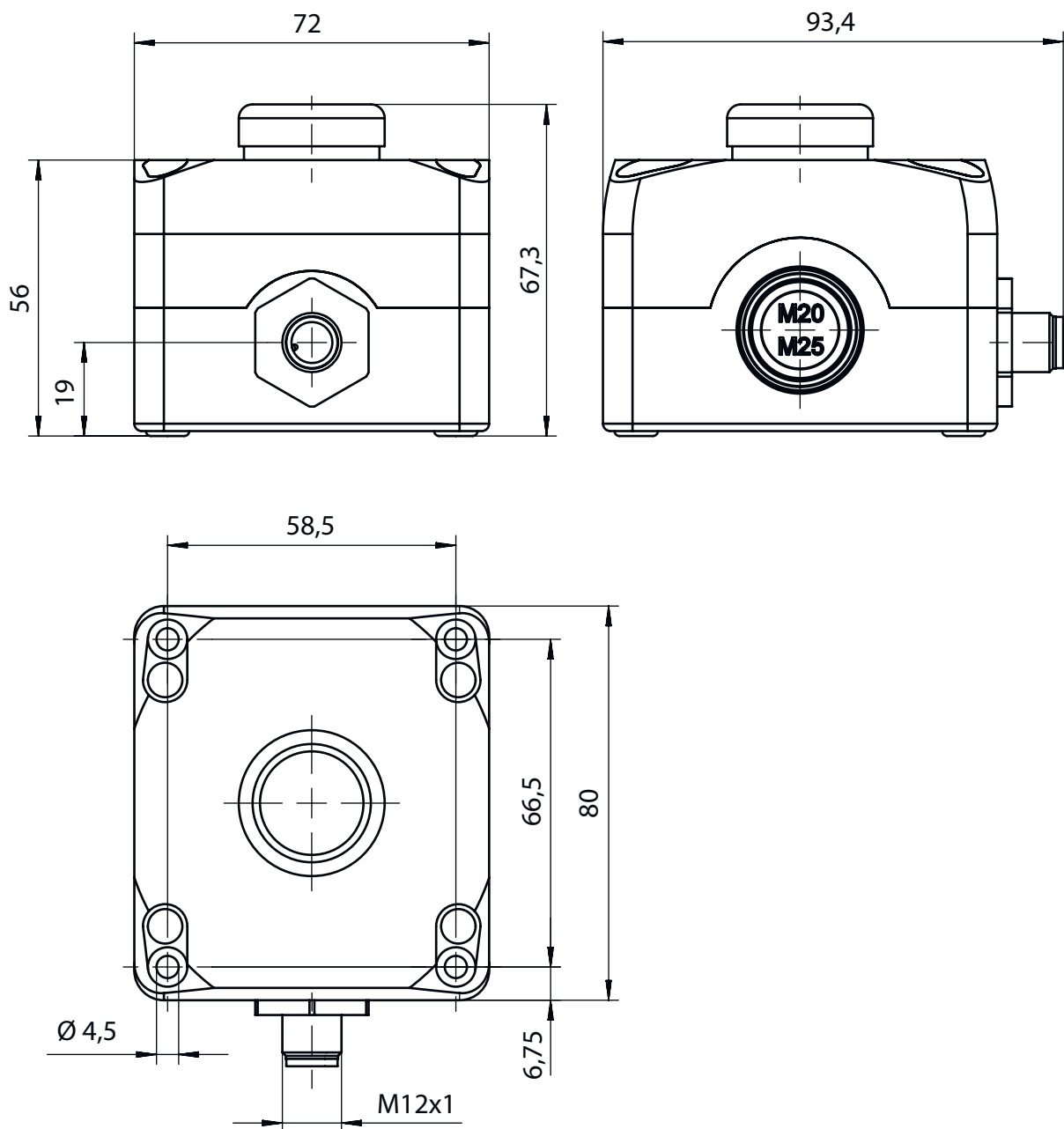

Electrical connection

Connection 1

Type of connection	Connector
Thread size	M12
Type	Male
Material	Plastic
No. of pins	4 -pin
Encoding	A-coded





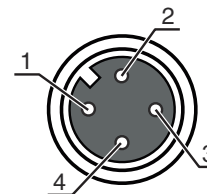



Electrical connection

Pin	Pin assignment	Conductor color
1	NO(1)	Brown
2	LED	White
3	LED	Blue
4	NO(1)	Black



Accessories

Connection technology - Connection cables

	Part no.	Designation	Article	Description
  	50130648	KD U-M12-4A-V1-020	Connection cable	Connection 1: Connector, M12, Axial, Female, A-coded, 4 -pin Connector, LED: No Connection 2: Open end Shielded: No Cable length: 2.000 mm Sheathing material: PVC
  	50130651	KD U-M12-4A-V1-030	Connection cable	Connection 1: Connector, M12, Axial, Female, A-coded, 4 -pin Connector, LED: No Connection 2: Open end Shielded: No Cable length: 3.000 mm Sheathing material: PVC
  	50130652	KD U-M12-4A-V1-050	Connection cable	Connection 1: Connector, M12, Axial, Female, A-coded, 4 -pin Connector, LED: No Connection 2: Open end Shielded: No Cable length: 5.000 mm Sheathing material: PVC

Note



A list with all available accessories can be found on the Leuze website in the Download tab of the article detailed page.