

Technical data sheet Safety locking device

Part no.: 50145104

L250-P32ML-M12B12-SCA



Contents

- Technical data
- Dimensioned drawings
- Electrical connection
- Notes
- Accessories



Technical data

Basic data

Series	L250
--------	------

Functions

Functions	Locking device with guard interlocking in acc. with EN ISO 14119 (type 4)
Activation mode of safety outputs	Safety outputs active if safety door is closed
Operating principle	Power to lock – Actuator locked if electromagnet is activated

Characteristic parameters

SIL	3, IEC 61508
SILCL	3, IEC/EN 62061
Performance Level (PL)	Up to and including e, EN ISO 13849-1
MTTF _d	2,254 years, EN ISO 13849-1
PFH _d	1.23E-09 per hour
Mission time T _M	20 years, EN ISO 13849-1
Category	4, EN ISO 13849
DC	High
Encoding level	Low, EN ISO 14119

Electrical data

Type of wiring	Series connection Single connection
External safeguarding for supply circuit	2A type Gg (or equivalent)

Performance data

Supply voltage U _B	24 V, DC, -10 ... 10 %
Current consumption, max.	1,200 mA

Inputs

Number of safety-related switching inputs	2 Piece(s)
Number of digital switching inputs	3 Piece(s)

Switching inputs

Type	Digital switching input
Switching voltage, type.	24 V
Voltage type	DC
Current consumption, type.	5 mA
Teach input for actuator	No

Digital switching input 1

Function	IE1 activation input: electromagnet
----------	-------------------------------------

Digital switching input 2

Function	IE2 activation input: electromagnet
----------	-------------------------------------

Digital switching input 3

Function	I3 control input for reset
----------	----------------------------

Safety-related switching inputs

Type	Safety switching input
Voltage type	DC
Switching voltage, type.	24 V
Current consumption, type.	5 mA

Outputs

Number of safety-related switching outputs (OSSDs)	2 Piece(s)
Number of digital switching outputs	2 Piece(s)

Safety-related switching outputs

Type	Safety-related switching output OSSD
Voltage type	DC

Safety-related switching output 1

Switching element	Transistor, PNP
-------------------	-----------------

Safety-related switching output 2

Switching element	Transistor, PNP
-------------------	-----------------

Switching outputs

Type	Digital switching output
Switching voltage, type.	24 V
Voltage type	DC

Switching output 1

Switching element	Transistor, PNP
Function	O3 signal output: protective-device closed

Switching output 2

Switching element	Transistor, PNP
Function	O4 signal output: protective-device locked

Connection

Number of connections	1 Piece(s)
-----------------------	------------

Connection 1

Function	Connection with PLC Contact connection Voltage supply
Type of connection	Connector
Thread size	M12
Type	Male
Material	Metal
No. of pins	12 -pin
Encoding	A-coded

Cable properties

Mechanical data

Design	Cubic
Dimension (W x H x L)	40 mm x 178 mm x 40 mm
Housing material	Plastic
Net weight	500 g
Housing color	Gray
Type of fastening	Through-hole mounting
Side of cable entry	From below
Switch type	Interlock device with guard interlocking
Approach speed	0.001 ... 0.5 m/s
Locking type	Electromagnetic
Locking actuation	Magnet
Locking force, max.	2,100 N
Mechanical life time	1,000,000 actuation cycles, IEC 60947-5-1 switching cycles
Actuation frequency, max.	600 per hour, IEC 60947-5-1
Extraction force, unlocked actuator	20 N

Technical data

RFID sensor data

Assured operating distance S_{ao}	2 mm
Assured cut-out distance S_{ar}	10 mm (actuator locked)
	6 mm (actuator not locked)
Nominal switching distance S_n	3 mm
Repeatability	$\leq 10\% S_n$
Differential travel	$\leq 20\% S_n$
Max. switching frequency	1 Hz

Operation and display

Type of display	LED
Number of LEDs	5 Piece(s)

Environmental data

Ambient temperature, operation	-20 ... 50 °C
Ambient temperature, storage	-40 ... 75 °C

Certifications

Degree of protection	IP 67
	IP 69K
Approvals	c UL US
	ECOLAB
	TÜV Süd

Classification

ECLASS 5.1.4	27272603
ECLASS 8.0	27272603
ECLASS 9.0	27272603
ECLASS 10.0	27272603
ECLASS 11.0	27272603
ECLASS 12.0	27272603
ECLASS 13.0	27272603
ECLASS 14.0	27272603
ECLASS 15.0	27272603
ETIM 5.0	EC002593
ETIM 6.0	EC002593
ETIM 7.0	EC002593
ETIM 8.0	EC002593
ETIM 9.0	EC002593
ETIM 10.0	EC002593

Dimensioned drawings

All dimensions in millimeters

Safety locking device

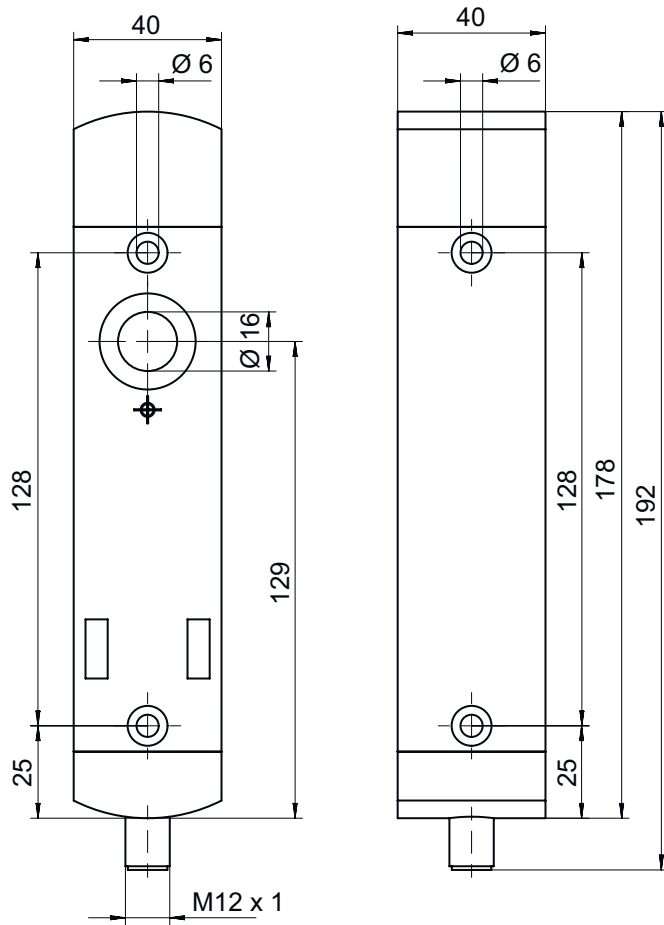

Actuator

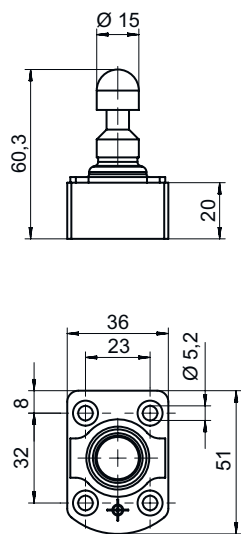

Electrical connection

Connection 1

Function	Connection with PLC Contact connection Voltage supply
Type of connection	Connector
Thread size	M12
Type	Male
Material	Metal
No. of pins	12 -pin
Encoding	A-coded

Pin	Pin assignment	Conductor color
1	A1 +24 V	Brown
2	IS1 safe input	Blue
3	A2 +0 V	White
4	OS1 safe output	Green
5	O3 signal output: protective-device closed	Pink
6	IS2 safe input	Yellow
7	OS2 safe output	Black
8	I3 programming input / control input for reset	Gray
9	O4 signal output: protective-device locked	Red
10	IE1 activation input: electromagnet	Violet
11	n.c.	Gray / Pink
12	IE2 activation input: electromagnet	Blue / Red

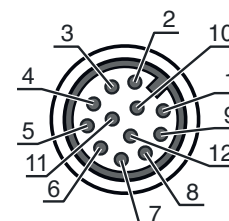

Notes

NOTE





The wire color specifications refer to the connection cables listed in the accessories.

Accessories

Connection technology - Connection cables

	Part no.	Designation	Article	Description
	50130281	KD S-M12-CA-P1-020	Connection cable	Connection 1: Connector, M12, Axial, Female, A-coded, 12 -pin Connector, LED: No Connection 2: Open end Shielded: Yes Cable length: 2.000 mm Sheathing material: PUR
	50130282	KD S-M12-CA-P1-050	Connection cable	Connection 1: Connector, M12, Axial, Female, A-coded, 12 -pin Connector, LED: No Connection 2: Open end Shielded: Yes Cable length: 5.000 mm Sheathing material: PUR

Accessories



	Part no.	Designation	Article	Description
	50130283	KD S-M12-CA-P1-100	Connection cable	Connection 1: Connector, M12, Axial, Female, A-coded, 12 -pin Connector, LED: No Connection 2: Open end Shielded: Yes Cable length: 10.000 mm Sheathing material: PUR
	50139769	KD U-M12-CA-P1-020	Connection cable	Connection 1: Connector, M12, Axial, Female, A-coded, 12 -pin Connector, LED: No Connection 2: Open end Shielded: No Cable length: 2.000 mm Sheathing material: PUR
	50139770	KD U-M12-CA-P1-050	Connection cable	Connection 1: Connector, M12, Axial, Female, A-coded, 12 -pin Connector, LED: No Connection 2: Open end Shielded: No Cable length: 5.000 mm Sheathing material: PUR
	50139771	KD U-M12-CA-P1-100	Connection cable	Connection 1: Connector, M12, Axial, Female, A-coded, 12 -pin Connector, LED: No Connection 2: Open end Shielded: No Cable length: 10.000 mm Sheathing material: PUR

Actuators

	Part no.	Designation	Article	Description
	50142133 **	AC-L250-UCA	Actuator	Code type: Unique code Encoding level: High, EN ISO 14119 Dimensions: 40 mm x 48.1 mm x 59.4 mm Housing material: Plastic Housing color: Black Type of fastening: Through-hole mounting

** Included in delivery contents

General

	Part no.	Designation	Article	Description
	50149361	AC-L250-LCKL	Lockout device	Dimensions: 52 mm x 63 mm x 140 mm Housing color: Black, Red Mounting: On left side Material: Metal, with powder coating
	50149360	AC-L250-LCKR	Lockout device	Dimensions: 52 mm x 63 mm x 140 mm Housing color: Black, Red Mounting: On right side Material: Metal, with powder coating

Accessories

	Part no.	Designation	Article	Description
	50149305	AC-L250-SH2-G0-B000-Z	Safety door handle	
	50149355	CD-B1-Z-C01	Command device	Functions: Protected screw fitting, Dimensions and design identical to L250 series locking devices Switching current via button: 0 ... 550 mA Housing material: Plastic, Glass fiber reinforced, self-extinguishing, shock-resistant Type of fastening: Through-hole mounting, Wall mounting Degree of protection: IP 65
	50149356	CD-B2-Z-C01	Command device	Functions: Protected screw fitting, Dimensions and design identical to L250 series locking devices Switching current via button: 0 ... 550 mA Housing material: Plastic, Glass fiber reinforced, self-extinguishing, shock-resistant Type of fastening: Through-hole mounting, Wall mounting Degree of protection: IP 65
	50149357	CD-B3-Z-C01	Command device	Functions: Position-dependent E-Stop command input, Dimensions and design identical to L250 series locking devices, Protected screw fitting, Reset function (via rotary knob, for E-Stop button) Switching current via button: 0 ... 550 mA Housing material: Plastic, Glass fiber reinforced, self-extinguishing, shock-resistant Type of fastening: Through-hole mounting, Wall mounting Degree of protection: IP 65

Note



A list with all available accessories can be found on the Leuze website in the Download tab of the article detailed page.