

Original operating instructions

MLC 320 Safety Light Curtains



© 2024

Leuze electronic GmbH + Co. KG

In der Braike 1

73277 Owen / Germany

Phone: +49 7021 573-0

Fax: +49 7021 573-199

www.leuze.com

info@leuze.com



| | | |
|----------|--|-----------|
| 1 | About this document | 5 |
| 1.1 | Used symbols and signal words | 5 |
| 1.2 | Checklists..... | 6 |
| 2 | Safety | 7 |
| 2.1 | Intended use and foreseeable misuse | 7 |
| 2.1.1 | Intended use..... | 7 |
| 2.1.2 | Foreseeable misuse | 8 |
| 2.2 | Necessary competencies | 8 |
| 2.3 | Responsibility for safety | 9 |
| 2.4 | Disclaimer | 9 |
| 3 | Device description | 10 |
| 3.1 | Device overview of the MLC family | 10 |
| 3.2 | Connection technology | 11 |
| 3.3 | Display elements..... | 12 |
| 3.3.1 | Operating indicators on the MLC 300 transmitter..... | 12 |
| 3.3.2 | Operating indicators on the MLC 320 receiver | 13 |
| 3.3.3 | Alignment display | 14 |
| 4 | Functions | 15 |
| 4.1 | Start/restart interlock RES | 15 |
| 4.2 | EDM contactor monitoring | 15 |
| 4.3 | Transmission channel changeover | 16 |
| 4.4 | Operating range selection..... | 16 |
| 5 | Applications | 17 |
| 5.1 | Point of operation guarding..... | 17 |
| 5.2 | Access guarding | 18 |
| 5.3 | Danger zone guarding | 18 |
| 6 | Mounting | 19 |
| 6.1 | Arrangement of transmitter and receiver | 19 |
| 6.1.1 | Calculation of safety distance S | 19 |
| 6.1.2 | Calculation of safety distance if protective fields act orthogonally to the approach direction ... | 20 |
| 6.1.3 | Calculation of safety distance S for parallel approach to the protective field | 24 |
| 6.1.4 | Minimum distance to reflective surfaces..... | 25 |
| 6.1.5 | Preventing mutual interference between adjacent devices | 27 |
| 6.2 | Mounting the safety sensor..... | 27 |
| 6.2.1 | Suitable mounting locations..... | 28 |
| 6.2.2 | Definition of directions of movement | 29 |
| 6.2.3 | Fastening via BT-NC60 sliding blocks..... | 29 |
| 6.2.4 | Fastening via BT-2HF swivel mount..... | 29 |
| 6.2.5 | Fastening via BT-2SB10 swiveling mounting brackets | 30 |
| 6.2.6 | One-sided mounting on the machine table..... | 31 |
| 6.3 | Mounting accessories | 31 |
| 6.3.1 | Deflecting mirror for multiple-side guarding..... | 31 |
| 6.3.2 | MLC-PS protective screen..... | 33 |

| | | |
|-----------|---|-----------|
| 7 | Electrical connection | 34 |
| 7.1 | Pin assignment transmitter and receiver..... | 34 |
| 7.1.1 | MLC 300 transmitter..... | 34 |
| 7.1.2 | MLC 320 receiver..... | 36 |
| 7.2 | Circuit diagram examples..... | 37 |
| 7.2.1 | MLC 320 circuit diagram example..... | 37 |
| 8 | Starting up the device | 38 |
| 8.1 | Switching on..... | 38 |
| 8.2 | Aligning the sensor | 38 |
| 8.3 | Aligning of deflecting mirrors with the laser alignment aid | 39 |
| 8.4 | Unlocking start/restart interlock..... | 40 |
| 9 | Testing | 41 |
| 9.1 | Before commissioning and following modifications..... | 41 |
| 9.1.1 | Checklist for integrator – to be performed prior to commissioning and following modifications | 41 |
| 9.2 | To be performed periodically by competent persons | 43 |
| 9.3 | Periodically by the operator | 43 |
| 9.3.1 | Checklist – periodically by the operator..... | 44 |
| 10 | Maintenance | 45 |
| 11 | Troubleshooting | 46 |
| 11.1 | What to do in case of failure? | 46 |
| 11.2 | Operating indicators of the LEDs | 47 |
| 11.3 | Error messages 7-segment display | 48 |
| 12 | Disposing | 50 |
| 13 | Service and support | 51 |
| 14 | Technical data | 52 |
| 14.1 | General specifications..... | 52 |
| 14.2 | Electromagnetic compatibility | 54 |
| 14.3 | Dimensions, weight, response time | 54 |
| 14.4 | Dimensioned drawings: Accessories | 57 |
| 15 | Order guide and accessories | 59 |
| 16 | EC Declaration of Conformity | 64 |



1 About this document

1.1 Used symbols and signal words

Tab. 1.1: Warning symbols and signal words

| | |
|---|--|
|  | Symbol indicating dangers to persons |
|  | Symbol indicating possible property damage |
| NOTE | Signal word for property damage Indicates dangers that may result in property damage if the measures for danger avoidance are not followed. |
| CAUTION | Signal word for minor injuries Indicates dangers that may result in minor injury if the measures for danger avoidance are not followed. |
| WARNING | Signal word for serious injury Indicates dangers that may result in severe or fatal injury if the measures for danger avoidance are not followed. |
| DANGER | Signal word for life-threatening danger Indicates dangers with which serious or fatal injury is imminent if the measures for danger avoidance are not followed. |

Tab. 1.2: Other symbols

| | |
|---|--|
|  | Symbol for tips Text passages with this symbol provide you with further information. |
|  | Symbol for action steps Text passages with this symbol instruct you to perform actions. |
|  | Symbol for action results Text passages with this symbol describe the result of the preceding action. |

Tab. 1.3: Terms and abbreviations

| | |
|-------------------|--|
| Response time | The response time of the protective device is the maximum time between the occurrence of the event that results in activation of the safety sensor and the provision of the switching signal at the interface of the protective device (e.g., OFF state of the OSSD pair). |
| AOPD | Active Optoelectronic Protective Device (A ctive O ptoelectronic P rotective D evice) |
| ESPE | E lectro-sensitive protective equipment |
| EDM | Contactormonitoring (E xternal D evice M onitoring) |
| LED | LED, display element in transmitter and receiver |
| MLC | Brief description of the safety sensor, consisting of transmitter and receiver |
| MTTF _d | Mean time to dangerous failure (M ean T ime T o dangerous F ailure) |
| OSSD | Safety-related switching output (O utput S ignal S witching D evice) |

| | |
|------------------|---|
| PFH _d | Probability of a dangerous failure per hour (P robability of dangerous F ailure per H our) |
| PL | P erformance L evel |
| RES | Start/restart interlock (Start/ RE start interlock) |
| Scan | Consecutive scans of the protective field from the first to the last beam |
| Safety sensor | System consisting of transmitter and receiver |
| SIL | S afety I ntegrity L evel |
| State | ON: device intact, OSSD switched on OFF: device intact, OSSD switched off Locking: device, connection or control / operation faulty, OSSD switched off (lock-out) |

1.2 Checklists

The checklists (see chapter 9 "Testing") serve as a reference for the machine manufacturer or supplier. They replace neither testing of the complete machine or system prior to initial commissioning nor their periodic testing by a qualified person (see chapter 2.2 "Necessary competencies"). The checklists contain minimum testing requirements. Depending on the application, other tests may be necessary.

2 Safety

see chapter 14.1 "General specifications"

For mounting, operating and testing, this document as well as all applicable national and international standards, regulations, rules and directives must be observed. Relevant and supplied documents must be observed, printed out and handed to affected persons.



↳ Before working with the safety sensor, completely read and observe the documents applicable to your task.

In particular, the following national and international legal regulations apply for the commissioning, technical inspections and work with safety sensors:

- Directive 2006/42/EC
- Directive 2014/35/EU
- Directive 2014/30/EU
- Directive 89/655/EEC supplemented by directive 95/63 EC
- OSHA 1910 Subpart O
- Safety regulations
- Accident-prevention regulations and safety rules
- Ordinance on Industrial Safety and Health and employment protection act
- Product Safety Law (ProdSG and 9. ProdSV)

| NOTICE | |
|--|---|
|  | <p>For safety-related information you may also contact local authorities (e.g., industrial inspectorate, employer's liability insurance association, labor inspectorate, occupational safety and health authority).</p> |

2.1 Intended use and foreseeable misuse

|  WARNING | |
|--|---|
|  | <p>A running machine may result in serious injury!</p> <p>↳ Make certain that the safety sensor is correctly connected and that the protective function of the protective device is ensured.</p> <p>↳ Make certain that, during all conversions, maintenance work and inspections, the system is securely shut down and protected against being restarted.</p> |

2.1.1 Intended use

- The safety sensor may only be used after it has been selected in accordance with the respectively applicable instructions and relevant standards, rules and regulations regarding labor protection and safety at work, and after it has been installed on the machine, connected, commissioned, and checked by a competent person (see chapter 2.2 "Necessary competencies"). The devices are designed for indoor use only.
- When selecting the safety sensor it must be ensured that its safety-related capability meets or exceeds the required performance level PL_r, ascertained in the risk assessment (see chapter 14.1 "General specifications").
- The safety sensor protects persons or body parts at points of operation, danger zones or access points of machines and systems.
- With the *access guarding* function, the safety sensor detects persons only when they enter the danger zone but cannot tell whether there are any persons inside the danger zone. For this reason, a start/restart interlock or a suitable stepping behind protection in the safety chain is essential in this case.
- Maximum permissible approach speeds (see ISO 13855):
 - 1.6 m/s for access guarding
 - 2.0 m/s for guards of points of operation

- The construction of the safety sensor must not be altered. When manipulating the safety sensor, the protective function is no longer guaranteed. Manipulating the safety sensor also voids all warranty claims against the manufacturer of the safety sensor.
- The improper repair of the protective device may result in loss of the protective function. Make no repairs to the device components.
- The safety sensor must be inspected regularly by a competent person to ensure proper integration and mounting (see chapter 2.2 "Necessary competencies").
- The safety sensor must be exchanged after a maximum of 20 years. Repairs or the exchange of wear parts do not extend the mission time.

2.1.2 Foreseeable misuse

Any use other than that defined under the "Approved purpose" or which goes beyond that use is considered improper use.

In principle, the safety sensor is **not** suitable as a protective device for use in the following cases:

- Danger posed by ejected objects or the spraying of hot or hazardous liquids from within the danger zone
- Applications in explosive or easily flammable atmospheres

2.2 Necessary competencies

The safety sensor may only be configured, installed, connected, commissioned, serviced and tested in its respective application by persons who are suitably qualified for the given task. General prerequisites for suitably qualified persons:

- They have a suitable technical education.
- They are familiar with the relevant parts of the operating instructions for the safety sensor and the operating instructions for the machine.

Task-specific minimum requirements for competent persons:

Configuration

Specialist knowledge and experience in the selection and use of protective devices on machines as well as the application of technical rules and the locally valid regulations on labor protection, safety at work and safety technology.

Specialist knowledge in programming safety-related controls SRASW acc. to EN ISO 13849-1.

Mounting

Specialist knowledge and experience needed for the safe and correct installation and alignment of the safety sensor with regard to the respective machine.

Electrical installation

Specialist knowledge and experience needed for the safe and correct electrical connection as well as safe integration of the safety sensor in the safety-related control system.

Operation and maintenance

Specialist knowledge and experience needed for the regular inspection and cleaning of the safety sensor – following instruction by the person responsible.

Servicing

Specialist knowledge and experience in the mounting, electrical installation and the operation and maintenance of the safety sensor in accordance with the requirements listed above.

Commissioning and testing

- Experience and specialist knowledge in the rules and regulations of labor protection, safety at work and safety technology that are necessary for being able to assess the safety of the machine and the use of the safety sensor, including experience with and knowledge of the measuring equipment necessary for performing this work.
- In addition, a task related to the subject matter is performed in a timely manner and knowledge is kept up to date through continuous further training - *Competent person* in terms of the German Betriebs-sicherheitsverordnung (Ordinance on Industrial Safety and Health) or other national legal regulations.

2.3 Responsibility for safety

Manufacturer and operator must ensure that the machine and implemented safety sensor function properly and that all affected persons are adequately informed and trained.

The type and content of all imparted information must not lead to unsafe actions by users.

The manufacturer of the machine is responsible for:

- Safe machine construction and information on any residual risks
- Safe implementation of the safety sensor, verified by the initial test performed by a competent person (see chapter 2.2 "Necessary competencies")
- Imparting all relevant information to the operating company
- Adhering to all regulations and directives for the safe commissioning of the machine

The operator of the machine is responsible for:

- Instructing the operator
- Maintaining the safe operation of the machine
- Adhering to all regulations and directives for labor protection and safety at work
- Periodic testing by a competent person (see chapter 2.2 "Necessary competencies")

2.4 Disclaimer

The liability of Leuze electronic GmbH + Co. KG is to be excluded in the following cases:

- Safety sensor is not used as intended.
- Safety notices are not adhered to.
- Reasonably foreseeable misuse is not taken into account.
- Mounting and electrical connection are not properly performed.
- Proper function is not tested (see chapter 9 "Testing").
- Changes (e.g., constructional) are made to the safety sensor.

3 Device description

The safety sensors from the MLC 300 series are active opto-electronic protective devices. They satisfy the following standards:

| | MLC 300 |
|---|---------|
| Type in accordance with EN IEC 61496 | 2 |
| Category in accordance with EN ISO 13849 | 2 |
| Performance Level (PL) in accordance with EN ISO 13849-1:2015 | c |
| Safety Integrity Level (SIL) in accordance with IEC 61508 and SILCL in accordance with EN IEC 62061 | 1 |

The safety sensor consists of a transmitter and a receiver (see chapter 3.1 "Device overview of the MLC family"). It is protected against overvoltage and overcurrent acc. to IEC 60204-1 (protection class 3). The safety sensor is not dangerously influenced by ambient light (e.g., welding sparks, warning lights).

3.1 Device overview of the MLC family

The series is characterized by two different receiver classes (Basic, Standard) with certain features and properties (see table below).

Tab. 3.1: Device models in the series with specific features and functions

| | Transmitter | Receiver | |
|---------------------------------|--------------------|--------------------|----------|
| | | Basic | Standard |
| | MLC 300 MLC 301 | MLC 310 MLC 311 | MLC 320 |
| OSSDs (2x) | | ■ | ■ |
| Transmission channel changeover | ■ | ■ | ■ |
| LED indicator | ■ | ■ | ■ |
| 7-segment display | | | ■ |
| Automatic start/restart | | ■ | ■ |
| RES | | | ■ |
| EDM | | | ■ |
| Range reduction | ■ | | |

Protective field properties

The beam distance and the number of beams are dependent on the resolution and protective field height.

| NOTICE | |
|---|--|
|  | Depending on the resolution, the effective protective field height can be larger than the optically active area of the safety sensor housed in yellow (see chapter 3.1 "Device overview of the MLC family" and see chapter 14.1 "General specifications"). |

Device synchronization

The synchronization of receiver and transmitter for creating a functioning protective field is done optically, i.e. without cables, via two specially coded synchronization beams. A cycle (i.e. a pass from the first to the last beam) is called a scan. The length of a scan determines the length of the response time and affects the calculation of the safety distance (see chapter 6.1.1 "Calculation of safety distance S").

| NOTICE | |
|---|---|
|  | For the correct synchronization and function of the safety sensor, at least one of the two synchronization beams must be free during synchronization and operation. |

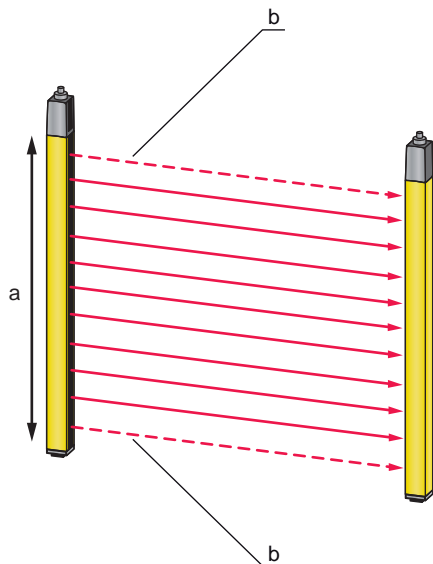

- a Optically active area, housed in yellow
- b Synchronization beams

Fig. 3.1: Transmitter-receiver system

QR code

A QR code as well as the corresponding web address are located on the safety sensor.

At the web address, you will find device information and error messages (see chapter 11.3 "Error messages 7-segment display") after scanning the QR code with a mobile end device or after entering the web address.

When using mobile end devices, mobile service charges can accrue.

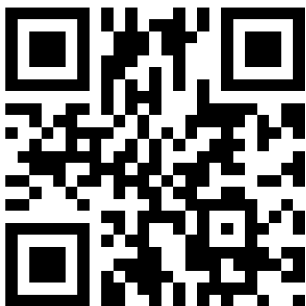

www.mobile.leuze.com/mlc/

Fig. 3.2: QR code with corresponding web address (URL) on the safety sensor

3.2 Connection technology

The transmitter and receiver feature an M12 connector as an interface to the machine control with the following number of pins:

| Device model | Device type | Device plug |
|--------------|-------------------|-------------|
| MLC 300 | Transmitter | 5-pin |
| MLC 320 | Standard receiver | 8-pin |

3.3 Display elements

The display elements of the safety sensors simplify start-up and fault analysis.

3.3.1 Operating indicators on the MLC 300 transmitter

Located in the connection cap on the transmitter are two LEDs which serve as function indicators:

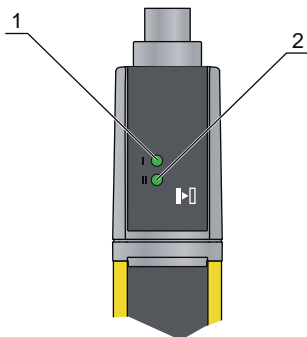

- 1 LED1, green/red
- 2 LED2, green

Fig. 3.3: Indicators on the MLC 300 transmitter

Tab. 3.2: Meaning of the LEDs on the transmitter

| State | | Description |
|-----------------|-----------------|--------------------------------------|
| LED1 | LED2 | |
| OFF | OFF | Device switched off |
| Green | OFF | Normal operation on channel 1 |
| Green | Green | Normal operation on channel 2 |
| Green, flashing | OFF | Reduced operating range on channel 1 |
| Green, flashing | Green, flashing | Reduced operating range on channel 2 |
| Red | OFF | Device error |
| Green | Red, flashing | External test (MLC 502 only) |

3.3.2 Operating indicators on the MLC 320 receiver

Two LEDs and a 7-segment display for showing the operating state are located on the receiver:

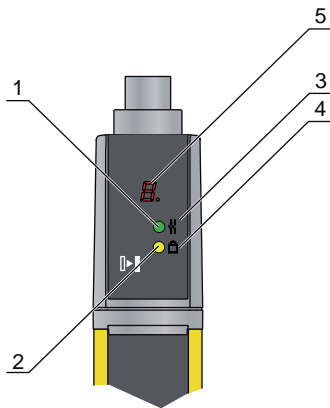

- 1 LED1, red/green
- 2 LED2, yellow
- 3 OSSD icon
- 4 RES icon
- 5 7-segment display

Fig. 3.4: Indicators on the MLC 320 receiver

Tab. 3.3: Meaning of the LEDs on the receiver

| LED | Color | State | Description |
|-----|-----------|---------------------------------------|--|
| 1 | Red/green | OFF | Device switched off |
| | | Red | OSSD off |
| | | Red, flashing slowly (approx. 1 Hz) | External error |
| | | Red, flashing fast (approx. 10 Hz) | Internal error |
| | | Green, flashing slowly (approx. 1 Hz) | OSSD on, weak signal |
| | | Green | OSSD on |
| 2 | Yellow | OFF | <ul style="list-style-type: none"> • RES deactivated • or RES activated and enabled • or RES blocked and protective field interrupted |
| | | ON | RES activated and blocked but ready to be unlocked - protective field free |

7-segment display at the MLC 320 receiver

In normal operation, the 7-segment display shows the number of the selected transmission channel. In addition, it helps during the detailed error diagnostics (see chapter 11 "Troubleshooting") and serves as an alignment aid (see chapter 8.2 "Aligning the sensor").

Tab. 3.4: Meaning of the 7-segment display

| Display | Description |
|------------------------------|---|
| After switching on | |
| 8 | Self test |
| t n n | Response time (t) of the receiver in milliseconds (n n) |
| In normal operation | |
| C1 | Transmission channel C1 |
| C2 | Transmission channel C2 |
| For alignment | |
| | Alignment display (see chapter 3.3.3 "Alignment display"). <ul style="list-style-type: none"> • Segment 1: beam area in upper third of the protective field • Segment 2: beam area in middle third of the protective field • Segment 3: beam area in lower third of the protective field |
| For error diagnostics | |
| F... | Failure, internal device error |
| E... | Error, external error |
| U... | Usage info, application error |

For error diagnostics, the error's respective letter is displayed first followed by the number code. The display is repeated cyclically. An AutoReset is carried out after 10 s for errors that do not cause locking, with an unauthorized restart being impossible. In the case of blocking errors, the voltage supply must be separated and the cause of the error must be eliminated. Before switching on again, the steps taken before initial commissioning must be repeated (see chapter 9.1 "Before commissioning and following modifications").

The 7-segment display switches to alignment mode when the device has not yet been aligned or when the protective field has been interrupted (after 5 s). In this case, a fixed beam area from the protective field is assigned to every segment.

3.3.3 Alignment display

Approximately 5 s after a protective-field interruption, the 7-segment display switches to alignment mode. In this mode, one third of the total protective field (top, middle, bottom) is assigned to one of the three horizontal segments. In the case of uniform resolution over the entire protected area, the state of this partial protective field is indicated as follows:

Tab. 3.5: Function of alignment display

| Segment | Description |
|--------------|---|
| On | All beams in the beam area are uninterrupted. |
| Flashing | At least one, but not all beams in the beam area are uninterrupted. |
| Switched off | All beams in the beam area are interrupted. |

When the protective field has been free for about 5 s, the device switches back to the display of the operating mode.

4 Functions

An overview of features and functions of the safety sensor can be found in chapter "Device description" (see chapter 3.1 "Device overview of the MLC family").



Overview of functions

- Start/restart interlock (RES)
- EDM
- Range reduction
- Transmission channel changeover

4.1 Start/restart interlock RES

After accessing the protective field, the start/restart interlock ensures that the safety sensor remains in the OFF state after the protective field has been cleared. It prevents automatic release of the safety circuits and automatic start-up of the system, e.g. if the protective field is again clear or if an interruption in the voltage supply is restored.

| NOTICE | |
|---|---|
|  | For access guarding, the start/restart interlock function is mandatory. The protective device may only be operated without start/restart interlock in certain exceptional cases and under certain conditions acc. to ISO 12100. |

|  WARNING | |
|--|--|
|  | <p>Deactivation of the start/restart interlock may result in serious injury!</p> <p>↳ Implement the start/restart interlock on the machine or in a downstream safety circuit.</p> |

Using start/restart interlock



↳ Wire the MLC 320 receiver appropriately for the desired operating mode (see chapter 7 "Electrical connection").

The start/restart interlock function is automatically activated.

Switching the safety sensor back on after shutting down (OFF state):

↳ Press the reset button (press/release between 0.15 s and 4 s)

| NOTICE | |
|---|---|
|  | The reset button must be located outside the danger zone in a safe place and give the operator a good view of the danger zone so that he/she can check whether anyone is located in it (according to IEC 62046) before pressing the reset button. |

|  DANGER | |
|---|--|
|  | <p>Risk of death if start/restart is operated unintentionally!</p> <p>↳ Ensure that the reset button for unlocking the start/restart interlock cannot be reached from the danger zone.</p> <p>↳ Before unlocking the start/restart interlock, make certain that no people are in the danger zone.</p> |

After the reset button has been actuated, the safety sensor switches to the ON state.

4.2 EDM contactor monitoring

| NOTICE | |
|---|---|
|  | The contactor monitoring of the MLC 320 safety sensors can be activated through appropriate wiring (see chapter 7.1.1 "MLC 300 transmitter")! |

The “contactor monitoring” function monitors the contactors, relays or valves connected downstream of the safety sensor. Prerequisite for this are switching elements with positive-guided feedback contacts (normally closed contacts).

Implement the contactor monitoring function:

- through appropriate wiring of the MLC 320 safety sensors (see chapter 7.1.1 "MLC 300 transmitter").
- through the external contactor monitoring of the downstream safety relay, (e.g. MSI series from Leuze electronic)
- or through contactor monitoring of the downstream safety PLC (optional, integrated via a safety bus)

If contactor monitoring is activated (see chapter 7 "Electrical connection"), it operates dynamically, i.e., in addition to monitoring the closed feedback circuit every time before the OSSDs are switched on, it also checks whether the release of the feedback circuit opened within 500 ms and, after the OSSDs are switched off, whether it has closed again within 500 ms. If this is not the case, the OSSDs return to the OFF state after being switched on briefly. An error message appears on the 7-segment display (E30, E31) and the receiver switches to the fault interlock state from which it can only be returned to normal operation by switching the supply voltage off and back on again.

4.3 Transmission channel changeover

Transmission channels are used to prevent mutual interference of safety sensors which are located close to each other.

| NOTICE | |
|--|---|
|  | To guarantee reliable operation, the infrared beams are modulated so they can be discerned from the ambient light. Welding sparks or warning lights, e.g. from passing high-lift trucks, thereby do not influence the protective field. |

With the factory setting, the safety sensor works in all operating modes with transmission channel 1.



| NOTICE | |
|---|--|
|  | Faulty function due to incorrect transmission channel! Select the same transmission channel on the transmitter and corresponding receiver. |

4.4 Operating range selection

In addition to selecting the suitable transmission channels (see chapter 4.3 "Transmission channel changeover"), the operating range selection also serves to prevent mutual interference of adjacent safety sensors. At reduced operating range the light power of the transmitter reduces, so that around half of the nominal range is reached.

Select operating range:

- ↳ Wire pin 4 (see chapter 7.1 "Pin assignment transmitter and receiver").
- ⇒ The wiring of pin 4 determines the transmitting power and thereby the range.

|  WARNING | |
|--|--|
|  | Impairment of the protective function due to incorrect transmitting power! The light power emitted from the transmitter is reduced through a single channel and without safety-relevant monitoring. ↳ Do not use this configuration option for safety purposes. ↳ Note that the distance to reflective surfaces must always be selected so that no reflection bypass can occur even at maximum transmitting power (see chapter 6.1.4 "Minimum distance to reflective surfaces"). |

5 Applications

The safety sensor only creates square protective fields.

5.1 Point of operation guarding

Point of operation guarding for hand and finger protection is typically the most common application for this safety sensor. In accordance with EN ISO 13855, resolutions from 14 to 40 mm make sense here. This yields the necessary safety distance, among others (see chapter 6.1.1 "Calculation of safety distance S").



Fig. 5.1: Point of operation guarding protects reaching into the danger zone, e.g. for cartoners or filling systems

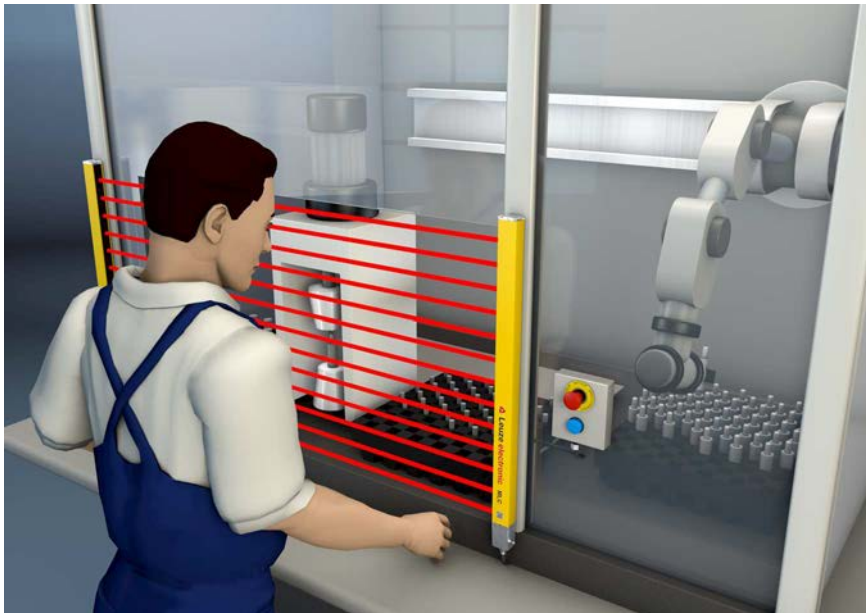

Fig. 5.2: Point of operation guarding protects reaching into the danger zone, e.g. for a pick & place robot application

5.2 Access guarding

Safety sensors with up to 90 mm resolution are used for access guarding into danger zones. They detect people only upon entry into the danger zone, i.e., they do not detect parts of a person or whether a person is present in the danger zone.

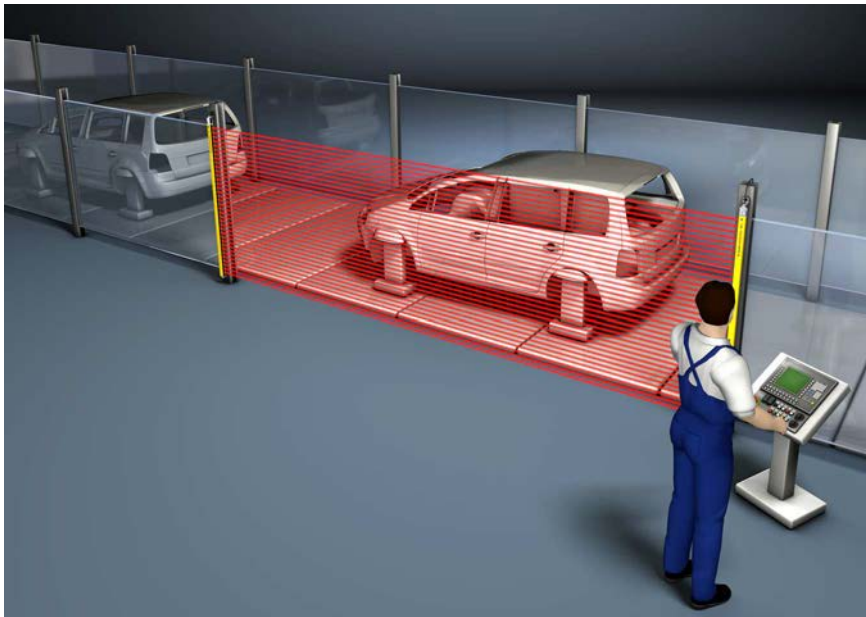

Fig. 5.3: Access guarding on a transfer path

5.3 Danger zone guarding

Safety light curtains can be used in horizontal arrangement for danger zone guarding - either as stand-alone device for presence monitoring or as stepping behind protection for presence monitoring e.g. in combination with a vertically-arranged safety sensor. Depending on the mounting height, resolutions of 40 or 90 mm are used (Link destination: order guide and accessories).

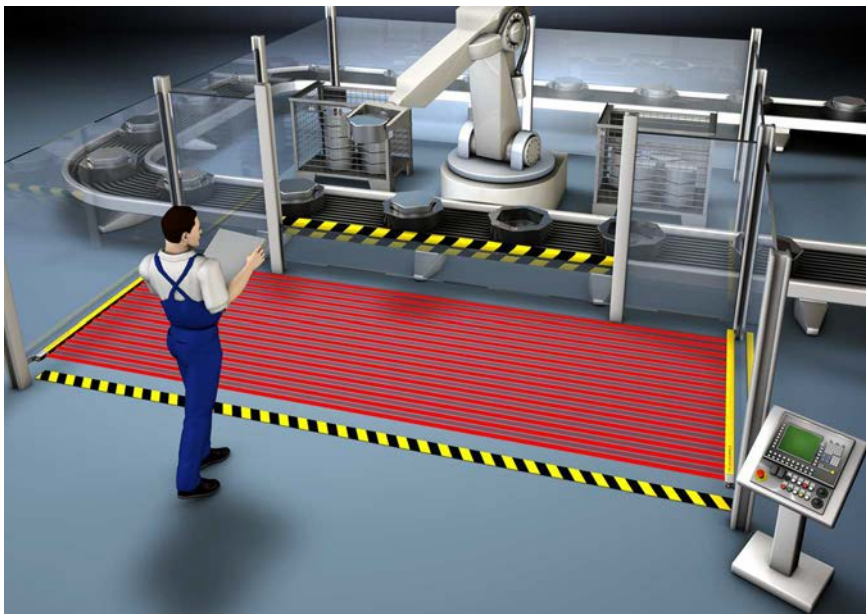



Fig. 5.4: Danger zone guarding on a robot

6 Mounting

| | |
|--|---|
|  WARNING | |
|  | <p>Improper mounting may result in serious injury!</p> <p>The protective function of the safety sensor is only ensured if appropriately and professionally mounted for the respective, intended area of application.</p> <ul style="list-style-type: none"> ↳ Only allow the safety sensor to be installed by qualified persons (see chapter 2.2 "Necessary competencies"). ↳ Maintain the necessary safety distances (see chapter 6.1.1 "Calculation of safety distance S"). ↳ Make sure that stepping behind, crawling under or stepping over the protective device is reliably ruled out and reaching under, over or around is taken into account in the safety distance, if applicable with additional distance C_{RO} corresponding to ISO 13855. ↳ Take measures to prevent that the safety sensor can be used to gain access to the danger zone, e.g. by stepping or climbing into it. ↳ Observe the relevant standards, regulations and these instructions. ↳ Clean the transmitter and receiver at regular intervals: environmental conditions (see chapter 14 "Technical data"), care (see chapter 10 "Maintenance"). ↳ After mounting, check the safety sensor for proper function. |

6.1 Arrangement of transmitter and receiver

Optical protective devices can only perform their protective function if they are mounted with adequate safety distance. When mounting, all delay times must be taken into account, such as the response times of the safety sensor and control elements as well as the stopping time of the machine, among others.

The following standards specify calculation formulas:

- IEC 61496-2, "Active optoelectronic protective devices": distance of the reflecting surfaces/deflecting mirrors
- ISO 13855, "Safety of machines - The positioning of protective equipment in respect of approach speeds of parts of the human body": mounting situation and safety distances

| | |
|---|--|
| NOTICE | |
|  | <p>In accordance with ISO 13855, with a vertical protective field, it is possible to pass under beams over 300 mm or pass over beams under 900 mm. If the protective field is horizontal, climbing on the safety sensor must be prevented through suitable installation or with covers and the like.</p> |

6.1.1 Calculation of safety distance S

General formula for calculating the safety distance S of an Optoelectronic Protective Device acc. to ISO 13855

$$S = K \cdot T + C$$

| | | | |
|-------|--------|---|---|
| S | [mm] | = | Safety distance |
| K | [mm/s] | = | Approach speed |
| T | [s] | = | Total time of the delay, sum from ($t_a + t_i + t_m$) |
| t_a | [s] | = | Response time of the protective device |
| t_i | [s] | = | Response time of the safety relay |
| t_m | [s] | = | Stopping time of the machine |
| C | [mm] | = | Additional distance to the safety distance |

| NOTICE | |
|---|---|
|  | If longer stopping times are determined during regular inspections, an appropriate additional time must be added to t_m . |

6.1.2 Calculation of safety distance if protective fields act orthogonally to the approach direction

With vertical protective fields, ISO 13855 differentiates between

- S_{RT} : safety distance concerning access **through** the protective field
- S_{RO} : safety distance concerning access **over** the protective field

The two values are distinguished by the way additional distance C is determined:

- C_{RT} : from a calculation formula or as a constant (see chapter 6.1.1 "Calculation of safety distance S")
- C_{RO} : from the following table "Reaching over the vertical protective field of electro-sensitive protective equipment (excerpt from ISO 13855)"

The larger of the two values S_{RT} and S_{RO} is to be used.

Calculation of safety distance S_{RT} acc. to ISO 13855 when access occurs through the protective field:

Calculation of safety distance S_{RT} for point of operation guarding

$$S_{RT} = K \cdot T + C_{RT}$$

| | | | |
|----------|--------|---|--|
| S_{RT} | [mm] | = | Safety distance |
| K | [mm/s] | = | Approach speed for point of operation guarding with approach reaction and normal approach direction to the protective field (resolution 14 to 40 mm): 2000 mm/s or 1600 mm/s, when $S_{RT} > 500$ mm |
| T | [s] | = | Total time of the delay, sum from ($t_a + t_i + t_m$) |
| t_a | [s] | = | Response time of the protective device |
| t_i | [s] | = | Response time of the safety relay |
| t_m | [s] | = | Stopping time of the machine |
| C_{RT} | [mm] | = | Additional distance for point of operation guarding with approach reaction with resolutions of 14 to 40 mm, $d =$ resolution of protective device $C_{RT} = 8 \times (d - 14)$ mm |

Calculation example

The feeding-in area in a press with a stopping time (including press Safety PLC) of 190 ms is to be safeguarded with a safety light curtain with 20 mm of resolution and 1200 mm of protective field height. The safety light curtain has a response time of 22 ms.

↳ Calculate safety distance S_{RT} using the formula acc. to ISO 13855.

$$S_{RT} = K \cdot T + C_{RT}$$

| | | | |
|----------------------------|-------------|---|--|
| K | [mm/s] | = | 2000 |
| T | [s] | = | (0.022 + 0.190) |
| C_{RT} | [mm] | = | $8 \times (20 - 14)$ |
| S_{RT} | [mm] | = | $2000 \text{ mm/s} \times 0.212 \text{ s} + 48 \text{ mm}$ |
| S_{RT} | [mm] | = | 472 |

S_{RT} is smaller than 500 mm; this is why the calculation may **not** be repeated with 1600 mm/s.

| NOTICE | |
|---|---|
|  | Implement the stepping behind protection required here, e.g., through the use of an additional or cascaded safety sensor for area protection. |

Calculation of safety distance S_{RT} for access guarding

$$S_{RT} = K \cdot T + C_{RT}$$

| | | | |
|----------|--------|---|---|
| S_{RT} | [mm] | = | Safety distance |
| K | [mm/s] | = | Approach speed for access guarding with approach direction orthogonal to the protective field: 2000 mm/s or 1600 mm/s, when $S_{RT} > 500$ mm |
| T | [s] | = | Total time of the delay, sum from ($t_a + t_i + t_m$) |
| t_a | [s] | = | Response time of the protective device |
| t_i | [s] | = | Response time of the safety relay |
| t_m | [s] | = | Stopping time of the machine |
| C_{RT} | [mm] | = | Additional distance for access guarding with approach reaction with resolutions of 14 to 40 mm, $d =$ resolution of protective device $C_{RT} = 8 \times (d - 14)$ mm. Additional distance for access guarding for resolutions > 40 mm: $C_{RT} = 850$ mm (standard value for arm length) |

Calculation example

Access to a robot with a stopping time of 250 ms is to be safeguarded with a safety light curtain with 90 mm of resolution and 1500 mm of protective field height whose response time is 6 ms. The safety light curtain directly switches the contactors whose response time is contained in the 250 ms. An additional interface therefore does not have to be taken into consideration.

↳ Calculate safety distance S_{RT} using the formula acc. to ISO 13855.

$$S_{RT} = K \cdot T + C_{RT}$$

| | | | |
|----------------------------|-------------|---|-------------------------------------|
| K | [mm/s] | = | 1600 |
| T | [s] | = | (0.006 + 0.250) |
| C_{RT} | [mm] | = | 850 |
| S_{RT} | [mm] | = | 1600 mm/s \times 0.256 s + 850 mm |
| S_{RT} | [mm] | = | 1260 |

This safety distance is not available in the application. This is why a new calculation is done with a safety light curtain with 40 mm of resolution (response time = 14 ms):

↳ Re-calculate safety distance S_{RT} using the formula acc. to ISO 13855.

$$S_{RT} = K \cdot T + C_{RT}$$

| | | | |
|----------------------------|-------------|---|-------------------------------------|
| K | [mm/s] | = | 1600 |
| T | [s] | = | (0.014 + 0.250) |
| C_{RT} | [mm] | = | $8 \times (40 - 14)$ |
| S_{RT} | [mm] | = | 1600 mm/s \times 0.264 s + 208 mm |
| S_{RT} | [mm] | = | 631 |

The safety light curtain with a 40 mm resolution is thus suitable for this application.

| NOTICE | |
|---|--|
|  | For the calculation with $K = 2000$ mm/s, safety distance S_{RT} equals 736 mm. The adoption of approach speed $K = 1600$ mm/s is therefore permitted. |

Calculation of safety distance S_{RO} acc. to ISO 13855 when protective field is accessed from above:

Calculation of safety distance S_{RO} for point of operation guarding

$$S_{RO} = K \cdot T + C_{RO}$$

- S_{RO} [mm] = Safety distance
- K [mm/s] = Approach speed for point of operation guarding with approach reaction and normal approach direction to the protective field (resolution 14 to 40 mm): 2000 mm/s or 1600 mm/s, when $S_{RO} > 500$ mm
- T [s] = Total time of the delay, sum from ($t_a + t_i + t_m$)
- t_a [s] = Response time of the protective device
- t_i [s] = Response time of the safety relay
- t_m [s] = Stopping time of the machine
- C_{RO} [mm] = Additional distance in which a body part can move towards the protective device before the protective device triggers: value (see the following table "Reaching over the vertical protective field of electro-sensitive protective equipment (excerpt from ISO 13855)").

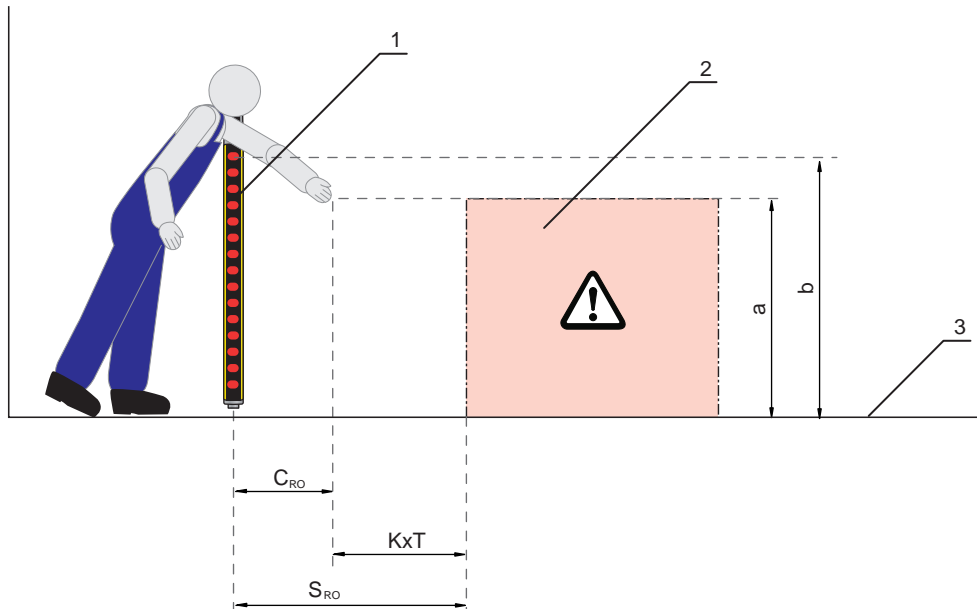

- 1 Safety sensor
- 2 Danger zone
- 3 Floor
- a Height of the point of operation
- b Height of the upper beam of the safety sensor

Fig. 6.1: Additional distance to the safety distance when reaching over and under

Tab. 6.1: Reaching over the vertical protective field of electro-sensitive protective equipment(excerpt from ISO 13855)

| Height a of the point of operation [mm] | Height b of the upper edge of the protective field of the electro-sensitive protective equipment | | | | | | | | | | | |
|---|--|------|------|------|------|------|------|------|------|------|------|------|
| | 900 | 1000 | 1100 | 1200 | 1300 | 1400 | 1600 | 1800 | 2000 | 2200 | 2400 | 2600 |
| | Additional distance C_{RO} to the danger zone [mm] | | | | | | | | | | | |
| 2600 | 0 | 0 | 0 | 0 | 0 | 0 | 0 | 0 | 0 | 0 | 0 | 0 |
| 2500 | 400 | 400 | 350 | 300 | 300 | 300 | 300 | 300 | 250 | 150 | 100 | 0 |
| 2400 | 550 | 550 | 550 | 500 | 450 | 450 | 400 | 400 | 300 | 250 | 100 | 0 |
| 2200 | 800 | 750 | 750 | 700 | 650 | 650 | 600 | 550 | 400 | 250 | 0 | 0 |

| Height a of the point of operation [mm] | Height b of the upper edge of the protective field of the electro-sensitive protective equipment | | | | | | | | | | | |
|---|--|------|------|------|------|------|------|------|------|------|------|------|
| | 900 | 1000 | 1100 | 1200 | 1300 | 1400 | 1600 | 1800 | 2000 | 2200 | 2400 | 2600 |
| | Additional distance C_{RO} to the danger zone [mm] | | | | | | | | | | | |
| 2000 | 950 | 950 | 850 | 850 | 800 | 750 | 700 | 550 | 400 | 0 | 0 | 0 |
| 1800 | 1100 | 1100 | 950 | 950 | 850 | 800 | 750 | 550 | 0 | 0 | 0 | 0 |
| 1600 | 1150 | 1150 | 1100 | 1000 | 900 | 850 | 750 | 450 | 0 | 0 | 0 | 0 |
| 1400 | 1200 | 1200 | 1100 | 1000 | 900 | 850 | 650 | 0 | 0 | 0 | 0 | 0 |
| 1200 | 1200 | 1200 | 1100 | 1000 | 850 | 800 | 0 | 0 | 0 | 0 | 0 | 0 |
| 1000 | 1200 | 1150 | 1050 | 950 | 750 | 700 | 0 | 0 | 0 | 0 | 0 | 0 |
| 800 | 1150 | 1050 | 950 | 800 | 500 | 450 | 0 | 0 | 0 | 0 | 0 | 0 |
| 600 | 1050 | 950 | 750 | 550 | 0 | 0 | 0 | 0 | 0 | 0 | 0 | 0 |
| 400 | 900 | 700 | 0 | 0 | 0 | 0 | 0 | 0 | 0 | 0 | 0 | 0 |
| 200 | 600 | 0 | 0 | 0 | 0 | 0 | 0 | 0 | 0 | 0 | 0 | 0 |
| 0 | 0 | 0 | 0 | 0 | 0 | 0 | 0 | 0 | 0 | 0 | 0 | 0 |

Depending on the specified values you can work with the above-mentioned table in three ways:

1. Given are:

- Height a of the point of operation
- Distance S of the point of operation from the safety sensor, and additional distance C_{RO}

To be determined is the required height b of the upper beam of the safety sensor and thereby its protective field height.

- ↪ Look for the line with the specification of the point of operation height in the left column.
- ↪ In this line, look for the column with the next highest specification for additional distance C_{RO} .
- ⇒ The required height of the upper beam of the safety sensor is up top in the column head.

2. Given are:

- Height a of the point of operation
- Height b of the upper beam of the safety sensor

To be determined is the required distance S of the safety sensor to the point of operation and thereby additional distance C_{RO} .

- ↪ In the column head, look for the column with the next lowest entry for the height of the upper beam of the safety sensor.
- ↪ Look for the line with the next highest specification of the point of operation height a in this column.
- ⇒ In the intersection point of the line and the column, you will find additional distance C_{RO} .

3. Given are:

- Distance S of the point of operation from the safety sensor, and additional distance C_{RO} .
- Height b of the upper beam of the safety sensor

To be determined is the permitted height a of the point of operation.

- ↪ In the column head, look for the column with the next lowest entry for the height of the upper beam of the safety sensor.
- ↪ Look for the next lowest value for real additional distance C_{RO} in this column.
- ⇒ In this line, go to the left column: here you will find the permitted height of the point of operation.
- ↪ Now calculate safety distance S using the general formula acc. to ISO 13855 (see chapter 6.1.1 "Calculation of safety distance S").
- ⇒ The larger of the two values S_{RT} and S_{RO} is to be used.

Calculation example

The feeding-in area in a press with a stopping time of 130 ms is to be safeguarded with a safety light curtain with 20 mm of resolution and 600 mm of protective field height. The response time of the safety light curtain is 12 ms; the press Safety PLC has a response time of 40 ms.

The safety sensor can be reached over. The upper edge of the protective field is located at a height of 1400 mm; the point of operation is located at a height of 1000 mm

Additional distance C_{RO} to the point of operation is 700 mm (see table "Reaching over the vertical protective field of electro-sensitive protective equipment (excerpt from ISO 13855)").

↳ Calculate safety distance S_{RO} using the formula acc. to ISO 13855.

$$S_{RO} = K \cdot T + C_{RO}$$

| | | | |
|----------------------------|-------------|---|------------------------------|
| K | [mm/s] | = | 2000 |
| T | [s] | = | (0.012 + 0.040 + 0.130) |
| C_{RO} | [mm] | = | 700 |
| S_{RO} | [mm] | = | 2000 mm/s × 0.182 s + 700 mm |
| S_{RO} | [mm] | = | 1064 |

S_{RO} is larger than 500 mm; this is why the calculation may be repeated with approach speed 1600 mm/s:

$$S_{RO} = K \cdot T + C_{RO}$$

| | | | |
|----------------------------|-------------|---|------------------------------|
| K | [mm/s] | = | 1600 |
| T | [s] | = | (0.012 + 0.040 + 0.130) |
| C_{RO} | [mm] | = | 700 |
| S_{RO} | [mm] | = | 1600 mm/s × 0.182 s + 700 mm |
| S_{RO} | [mm] | = | 992 |

NOTICE

Depending on the machine construction, stepping behind protection, e.g. using a second horizontally arranged safety light curtain, is necessary. In most cases, it will be more appropriate to choose a longer safety light curtain which makes the additional distance C_{RO} equal to 0.

6.1.3 Calculation of safety distance S for parallel approach to the protective field**Calculation of safety distance S for danger zone guarding**

$$S = K \cdot T + C$$

| | | | |
|-------|--------|---|---|
| S | [mm] | = | Safety distance |
| K | [mm/s] | = | Approach speed for danger zone guarding with approach direction parallel to the protective field (resolution up to 90 mm): 1600 mm/s |
| T | [s] | = | Total time of the delay, sum from ($t_a + t_i + t_m$) |
| t_a | [s] | = | Response time of the protective device |
| t_i | [s] | = | Response time of the safety relay |
| t_m | [s] | = | Stopping time of the machine |
| C | [mm] | = | Additional distance for danger zone guarding with approach reaction H = height of the protective field, H_{min} = minimum installation height permitted, but no smaller than 0, d = resolution of the protective device $C = 1200 \text{ mm} - 0.4 \times H$; $H_{min} = 15 \times (d - 50)$ |

Calculation example

The danger zone in front of a machine with a stopping time of 140 ms is to be safeguarded as close to the floor height as possible using a horizontal safety light curtain as a replacement for a PS mat. Installation height H_{min} can be = 0 - additional distance C to the safety distance is then 1200 mm. The shortest possible safety sensor is to be used; the first value to be selected is to be 1350 mm.

The receiver with 40 mm of resolution and 1350 mm protective field height has a response time of 13 ms, an additional relay interface a response time of 10 ms.

↳ Calculate safety distance S_{RO} using the formula acc. to ISO 13855.

$$S = K \cdot T + C$$

- K [mm/s] = 1600
- T [s] = (0.140 + 0.013 + 0.010)
- C [mm] = 1200
- S [mm] = 1600 mm/s × 0.163 s + 1200 mm
- S [mm] = 1461**

The safety distance of 1350 mm is not sufficient; 1460 mm are necessary.

This is why the calculation is repeated with a protective field height of 1500 mm. The response time is now 14 ms.



↳ Re-calculate safety distance S_{RO} using the formula acc. to ISO 13855.

$$S = K \cdot T + C$$

- K [mm/s] = 1600
- T [s] = (0.140 + 0.014 + 0.010)
- C [mm] = 1200
- S [mm] = 1600 mm/s × 0.164 s + 1200 mm
- S [mm] = 1463**

A suitable safety sensor has been found; its protective field height is 1500 mm.

6.1.4 Minimum distance to reflective surfaces

| | |
|--|---|
|  WARNING | |
|  | <p>Failure to maintain minimum distances to reflective surfaces may result in serious injury!</p> <p>Reflective surfaces can indirectly deflect the transmitter beams to the receiver. In this case, interruption of the protective field is not detected.</p> <ul style="list-style-type: none"> ↳ Determine the minimum distance a (see figure below). ↳ Make certain that all reflective surfaces are the necessary minimum distance away from the protective field according to IEC 61496-2 (see the following diagram “Minimum distance to reflective surfaces as a function of the protective field width”). ↳ Check that reflective surfaces do not impair the detection capability of the safety sensor before start-up and at appropriate intervals. |

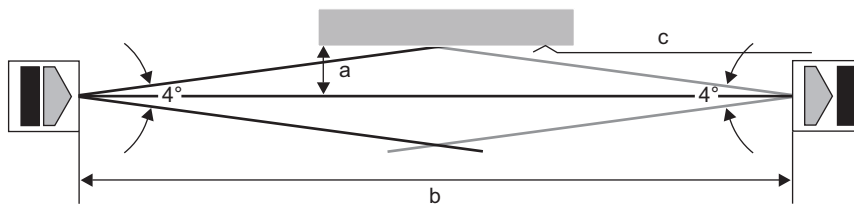

- a Required minimum distance to reflective surfaces [mm]
- b Protective field width [m]
- c Reflective surface

Fig. 6.2: Minimum distance to reflective surfaces depending on protective field width

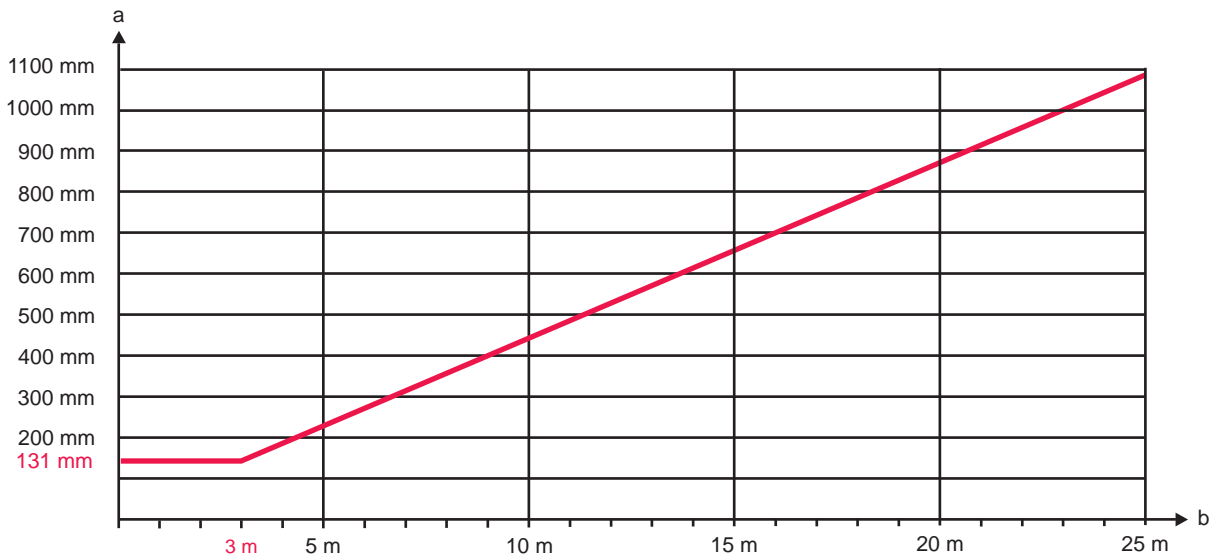

- a Required minimum distance to reflective surfaces [mm]
- b Protective field width [m]

Fig. 6.3: Minimum distance to reflective surfaces as a function of the protective field width

Tab. 6.2: Formula for calculating the minimum distance to reflective surfaces

| Distance (b) transmitter-receiver | Calculation of the minimum distance (a) to reflective surfaces |
|-----------------------------------|--|
| $b \leq 3 \text{ m}$ | $a \text{ [mm]} = 131$ |
| $b > 3 \text{ m}$ | $a \text{ [mm]} = \tan(2.5^\circ) \times 1000 \times b \text{ [m]} = 43.66 \times b \text{ [m]}$ |

6.1.5 Preventing mutual interference between adjacent devices

If a receiver is located in the beam path of an adjacent transmitter, optical crosstalk, and thus erroneous switching and failure of the protective function, may result.

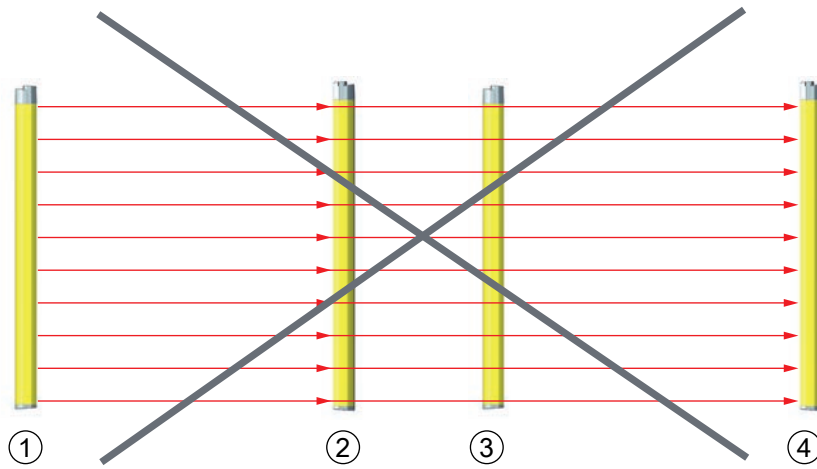

- 1 Transmitter 1
- 2 Receiver 1
- 3 Transmitter 2
- 4 Receiver 2

Fig. 6.4: Optical crosstalk between adjacent safety sensors (transmitter 1 influences receiver 2) due to incorrect mounting

NOTICE

 **Possible impairment of the availability due to systems mounted close to each other!**
 The transmitter of one system can influence the receiver of the other system.
 ↪ Prevent optical crosstalk between adjacent devices.

↪ Mount adjacent devices with a shield between them or install a dividing wall to prevent mutual interference.

↪ Mount the adjacent devices opposite from one another to prevent mutual interference.

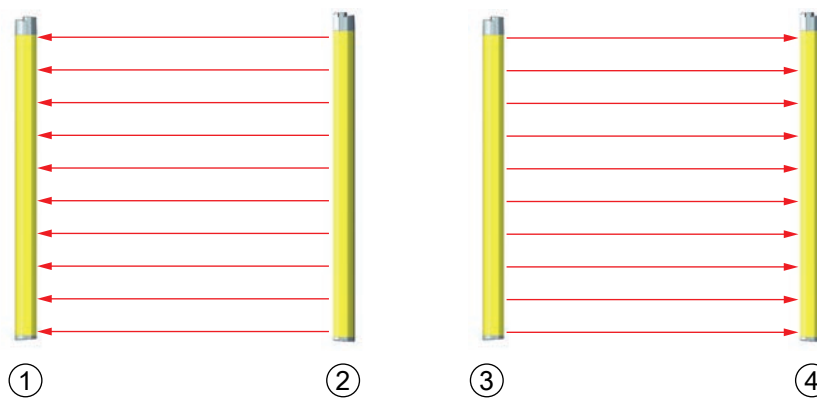

- 1 Receiver 1
- 2 Transmitter 1
- 3 Transmitter 2
- 4 Receiver 2

Fig. 6.5: Opposite mounting

6.2 Mounting the safety sensor

Proceed as follows:

- Select the type of fastening, e.g. sliding blocks (see chapter 6.2.3 "Fastening via BT-NC60 sliding blocks").
- Have a suitable tool at hand and mount the safety sensor in accordance with the notices regarding the mounting locations (see chapter 6.2.1 "Suitable mounting locations").
- If possible, affix safety notice stickers on the mounted safety sensor or device column (included in delivery contents).

After mounting, you can electrically connect (see chapter 7 "Electrical connection"), start up, align (see chapter 8 "Starting up the device"), and test (see chapter 9.1 "Before commissioning and following modifications") the safety sensor.

6.2.1 Suitable mounting locations

Area of application: Mounting

Tester: Technician who mounts the safety sensor

Tab. 6.3: Checklist for mounting preparations

| Check: | Yes | No |
|---|-----|----|
| Do the protective field height and dimensions satisfy the requirements of ISO 13855? | | |
| Is the safety distance to the point of operation maintained (see chapter 6.1.1 "Calculation of safety distance S")? | | |
| Is the minimum distance to reflective surfaces maintained (see chapter 6.1.4 "Minimum distance to reflective surfaces")? | | |
| Is it impossible for safety sensors that are mounted next to one another to mutually interfere with one another (see chapter 6.1.5 "Preventing mutual interference between adjacent devices")? | | |
| Can the point of operation or the danger zone only be accessed through the protective field? | | |
| Has bypassing the protective field by crawling under, reaching over, or jumping over been prevented or has corresponding additional distance C_{RO} in accordance with ISO 13855 been observed? | | |
| Is stepping behind the protective device prevented or is mechanical protection available? | | |
| Do the transmitter and receiver connections point in the same direction? | | |
| Can the transmitter and receiver be fastened in such a way that they cannot be moved and turned? | | |
| Is the safety sensor accessible for testing and replacing? | | |
| Is it impossible to actuate the reset button from within the danger zone? | | |
| Can the entire danger zone be seen from the installation site of the reset button? | | |
| Can reflection caused by the installation site be ruled out? | | |

| NOTICE | |
|---|---|
|  | If you answer one of the items on the checklist above with no , the mounting location must be changed. |

6.2.2 Definition of directions of movement

The following terms for alignment movements of the safety sensor around one of its axes are used:

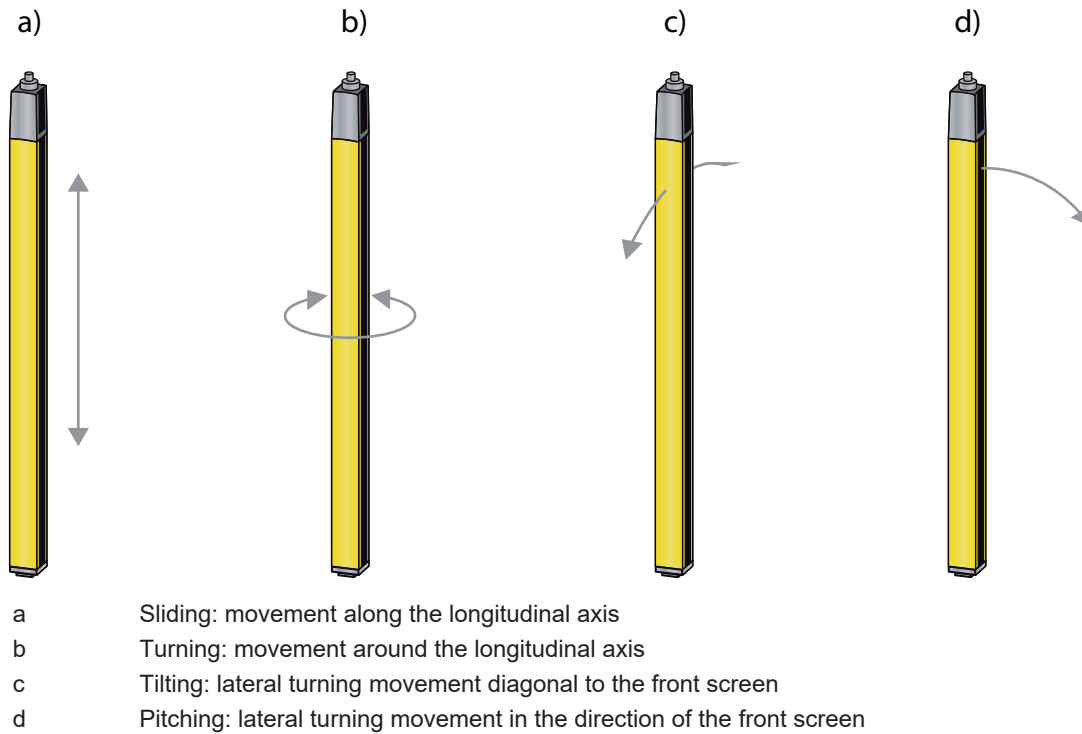

Fig. 6.6: Directions of movement during alignment of the safety sensor

6.2.3 Fastening via BT-NC60 sliding blocks

By default, transmitter and receiver are delivered with 2 BT-NC60 sliding blocks each in the side slot. This makes fastening the safety sensor to the machine or system to be safeguarded easy via four M6 screws. Sliding in the direction of slot to set the height is possible, but turning, tilting and pitching is not.

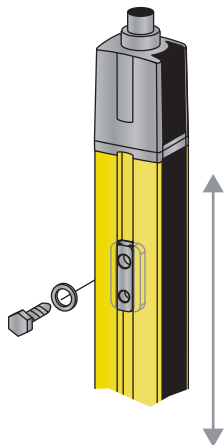

Fig. 6.7: Mounting via sliding blocks BT-NC60

6.2.4 Fastening via BT-2HF swivel mount

With the swivel mount (see chapter 15 "Order guide and accessories"), sold separately, the safety sensor can be aligned as follows:

- Sliding through the vertical threaded holes in the wall plate of the swivel mount
- Turning by 360° around the longitudinal axis by fixing on the screw-on cone
- Pitching in the direction of the protective field with horizontal threaded holes in the wall mounting
- Tilting around main axis

The wall mounting through threaded holes makes it possible to lift the mounting bracket after the screws have been loosened over the connection cap. Therefore, the mounting brackets do not need to be removed from the wall when exchanging the device. Loosening the screws is sufficient.

For increased mechanical loads, mounting brackets are also available in a vibration-damped version (BT-2HF-S) (see chapter 15 "Order guide and accessories").

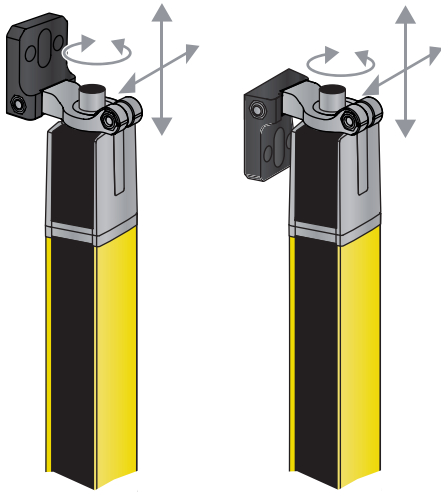

Fig. 6.8: Mounting via swivel mount BT-2HF

6.2.5 Fastening via BT-2SB10 swiveling mounting brackets

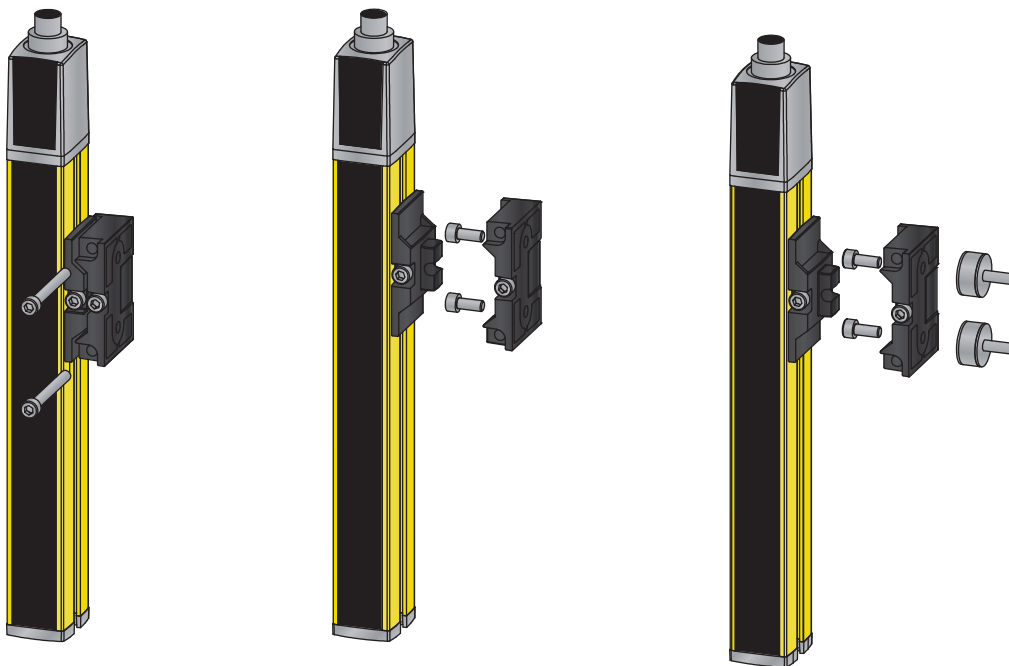

Fig. 6.9: Mounting via swiveling mounting brackets BT-2SB10

For larger protective field heights > 900 mm, the use of the BT-2SB10 swiveling mounting brackets is recommended (see chapter 15 "Order guide and accessories"). For increased mechanical requirements, these are also available as vibration-damped version (BT-2SB10-S). Depending on the installation situation, environmental conditions and protective field length (> 1200 mm), other mounting brackets may also be necessary.

6.2.6 One-sided mounting on the machine table

The safety sensor can be mounted directly on the machine table via an M5 screw on the blind hole in the end cap. On the other end, a BT-2HF swivel mount can be used, for example, so that turning movements for alignment are possible despite the fact that the sensor is mounted on one side. The full resolution of the safety sensor is thus preserved on all points of the protective field down to the machine table.

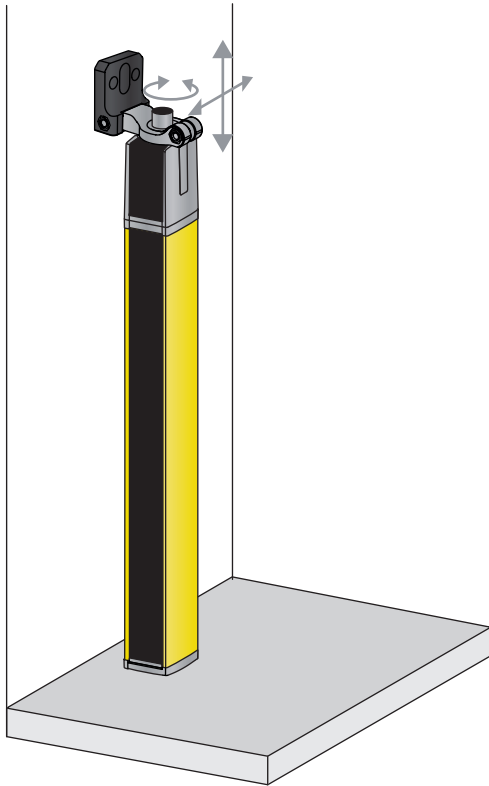



Fig. 6.10: Mounting directly on the machine table

|  WARNING | |
|--|--|
|  | <p>Impairment of the protective function due to reflections on the machine table!</p> <ul style="list-style-type: none"> ↳ Make sure that reflections on the machine table are prevented reliably. ↳ After mounting and every day after that, check the detection capability of the safety sensor in the entire protective field using a test rod (see chapter 9.3.1 "Checklist – periodically by the operator"). |

6.3 Mounting accessories

6.3.1 Deflecting mirror for multiple-side guarding

For multiple-side guarding, redirecting the protective field with one or two deflecting mirrors is economical. To do this, Leuze electronic supplies:

- The UM60 deflecting mirror for mounting on the machine in various lengths (see chapter 15 "Order guide and accessories")
- suitable BT-2UM60 swivel mounts
- UMC-1000-S2 ... UMC-1900-S2 deflecting mirror columns with spring-damped base for free-standing floor mounting

The range is reduced by approx. 10 % per deflection. A laser alignment aid with red light laser is recommended for the alignment of transmitter and receiver (see chapter 8.3 "Aligning of deflecting mirrors with the laser alignment aid").

↳ Note that the distance between the transmitter and the first deflecting mirror cannot be larger than 3 m.

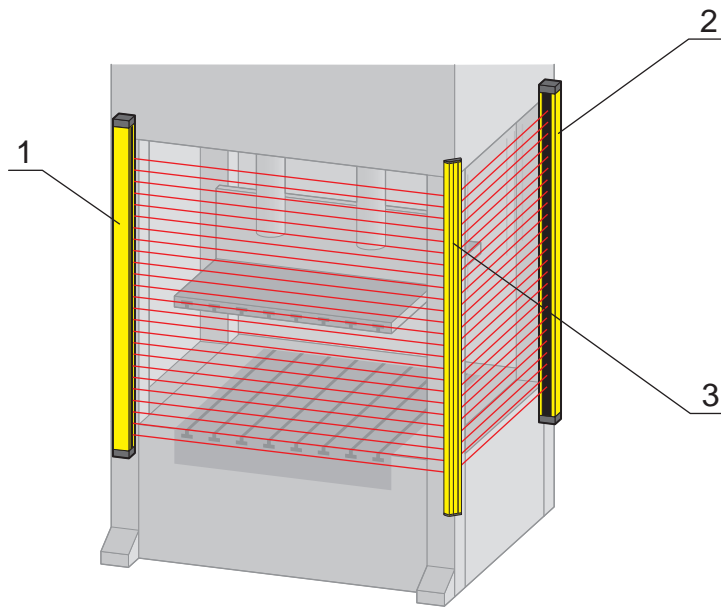

- 1 Transmitter
- 2 Receiver
- 3 UM60 deflecting mirrors

Fig. 6.11: Arrangement with deflecting mirror for 2-side guarding of a point of operation

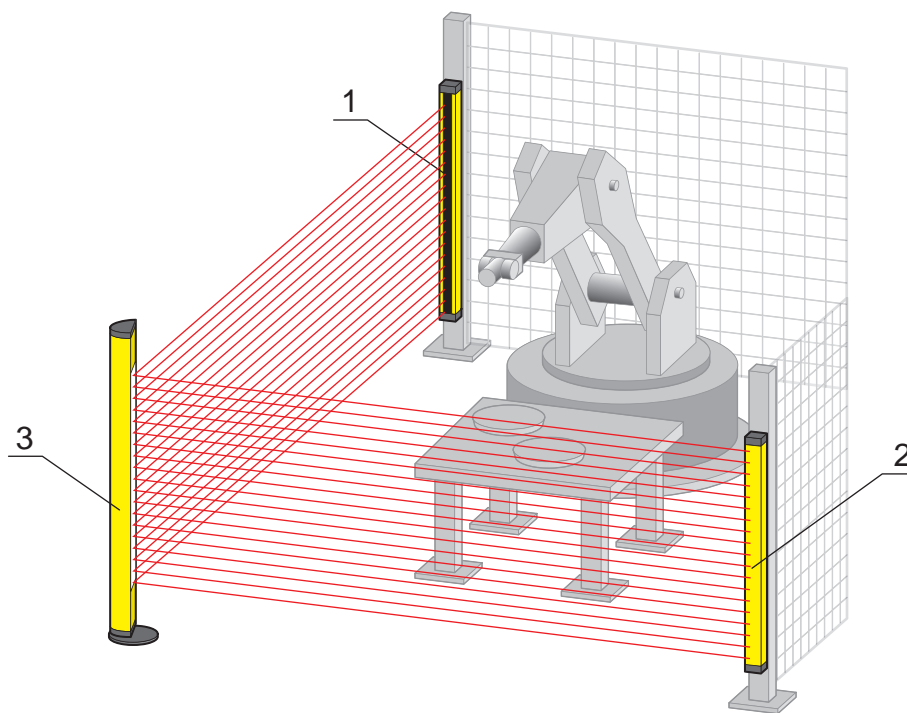

- 1 Transmitter
- 2 Receiver
- 3 UMC deflecting mirror columns

Fig. 6.12: Arrangement with deflecting mirror columns for two-side guarding of a point of operation

6.3.2 MLC-PS protective screen

If there is a risk that the protective plastic screens of the safety sensors could get damaged, e.g. by welding sparks, placing the additional, easy-to-replace MLC-PS protective screen in front of the safety sensors can protect the device protective screen and considerably increase the availability of the safety sensor. Mounting is performed using special clamp brackets, which are fastened on the lateral slot, via an Allen screw accessible from the front on each. The range of the safety sensor is reduced by approx. 5%; when protective screens are used on the transmitter and the receiver it is reduced by 10%. Mounting bracket sets with 2 and 3 clamp brackets are available.

NOTICE



If the length equals 1200 mm or higher, 3 clamp brackets are recommended.

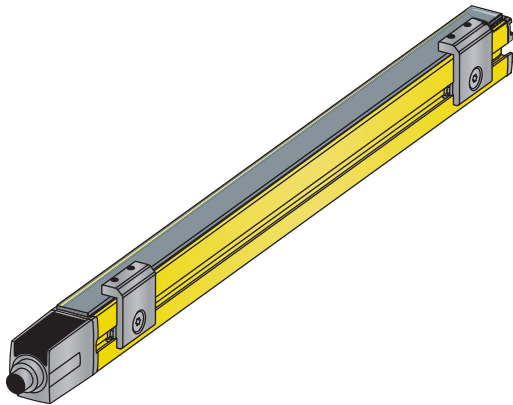







Fig. 6.13: MLC-PS protective screen fastened with MLC-2PSF clamp bracket

7 Electrical connection

| | |
|--|---|
|  WARNING | |
|  | <p>Faulty electrical connection or improper function selection may result in serious injury!</p> <ul style="list-style-type: none"> ↪ Only allow qualified persons (see chapter 2.2 "Necessary competencies") to perform the electrical connection. ↪ Make certain that the safety sensor is protected against overcurrent. ↪ For access guarding, activate the start/restart interlock and make certain that it cannot be unlocked from within the danger zone. ↪ Select the functions so that the safety sensor can be used as intended (see chapter 2.1 "Intended use and foreseeable misuse"). ↪ Select the safety-relevant functions for the safety sensor (see chapter 4 "Functions"). ↪ Always loop both safety-related switching outputs OSSD1 and OSSD2 into the work circuit of the machine. ↪ Signal outputs must not be used for switching safety-relevant signals. |
| NOTICE | |
|  | <p>SELV/PELV!</p> <ul style="list-style-type: none"> ↪ Acc. to EN 60204-1, the external power supply must demonstrate the ability to bridge short-term mains failures of up to 20 ms. The power supply unit must ensure safe mains separation (SELV/PELV) and a current reserve of at least 2 A. |
| NOTICE | |
|  | <p>Laying cables!</p> <ul style="list-style-type: none"> ↪ Lay all connection cables and signal lines within the electrical installation space or permanently in cable ducts. ↪ Lay the cables and lines so that they are protected against external damages. ↪ For further information: see EN ISO 13849-2, Table D.4. |
| NOTICE | |
|  | <p>For special EMC stress, the use of shielded cables is recommended.</p> |

7.1 Pin assignment transmitter and receiver

7.1.1 MLC 300 transmitter

MLC 300 transmitters are equipped with a 5-pin M12 connector.

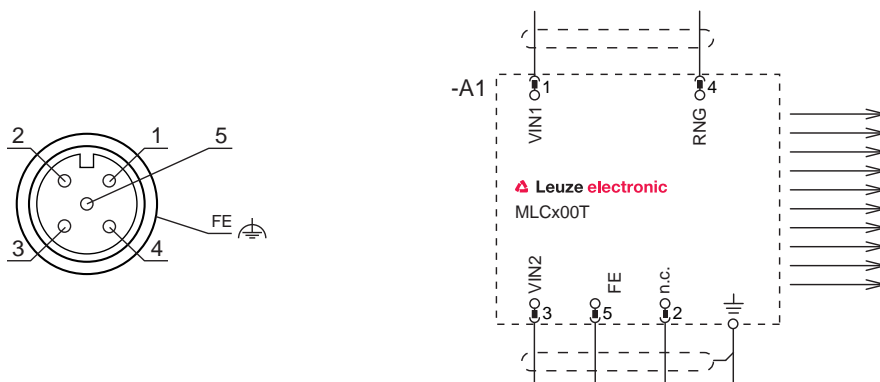

Fig. 7.1: Pin assignment and connection diagram transmitter

Tab. 7.1: Pin assignment transmitter

| Pin | Core color (CB-M12-xx000E-5GF) | Transmitter |
|-----|--------------------------------|-------------------------------|
| 1 | Brown | VIN1 - supply voltage |
| 2 | White | n.c. |
| 3 | Blue | VIN2 - supply voltage |
| 4 | Black | RNG - range |
| 5 | Gray | FE - functional earth, shield |
| FE | | FE - functional earth, shield |

The polarity of the supply voltage selects the transmission channel of the transmitter:

- VIN1 = +24 V, VIN2 = 0 V: transmission channel C1
- VIN1 = 0 V, VIN2 = +24 V: transmission channel C2

The wiring of pin 4 determines the transmitting power and thereby the range:

- Pin 4 = +24 V: standard range
- Pin 4 = 0 V or open: reduced range

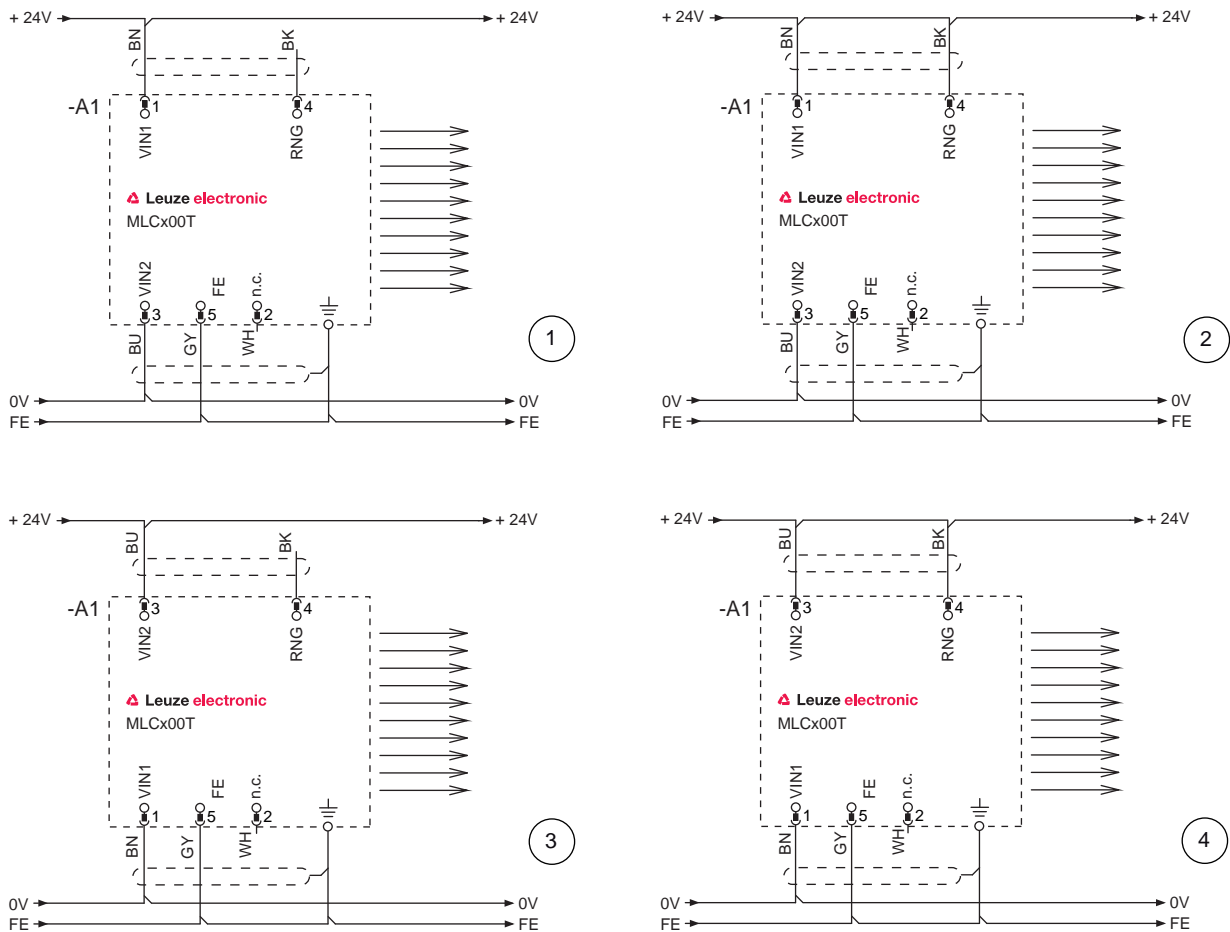

Fig. 7.2: Connection examples transmitter

7.1.2 MLC 320 receiver

MLC 320 receivers are equipped with a 8-pin M12 connector.

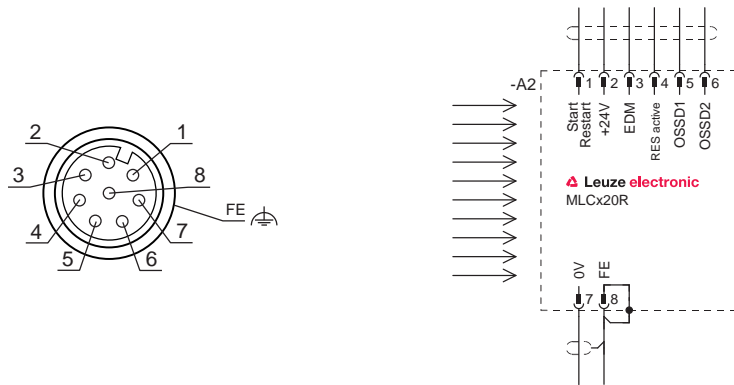

Fig. 7.3: Pin assignment and connection diagram receiver

Tab. 7.2: Pin assignment receiver

| Pin | Core color (CB-M12-xx000E-5GF) | Receiver |
|-----|--------------------------------|---|
| 1 | White | IO1 - control input reset button, signal output Start/restart NO to 24 V DC Output reset button lamp (inverted OSSD) |
| 2 | Brown | VIN1 - supply voltage 24 V DC for transmission channel C1 0 V for transmission channel C2 |
| 3 | Green | IN3 - control-input contactor monitoring (EDM) 24 V DC: without EDM 0 V: with EDM and feedback circuit closed High-impedance: with EDM and feedback circuit open |
| 4 | Yellow | IN4 - control input for start/restart interlock (RES) 24 V DC: with RES Bridge to pin 1: without RES (note: signal output remains functional) |
| 5 | Gray | OSSD1 - safety-related switching output |
| 6 | Pink | OSSD2 - safety-related switching output |
| 7 | Blue | VIN2 - supply voltage 0 V: for transmission channel C1 24 V DC for transmission channel C2 |
| 8 | Red | FE - functional earth, shield Wired in device interior on the housing |

| Pin | Core color (CB-M12-xx000E-5GF) | Receiver |
|-----|--------------------------------|-------------------------------|
| FE | | FE - functional earth, shield |

The polarity of the supply voltage selects the transmission channel of the receiver:

- VIN1 = +24 V, VIN2 = 0 V: transmission channel C1
- VIN1 = 0 V, VIN2 = +24 V: transmission channel C2

7.2 Circuit diagram examples

7.2.1 MLC 320 circuit diagram example

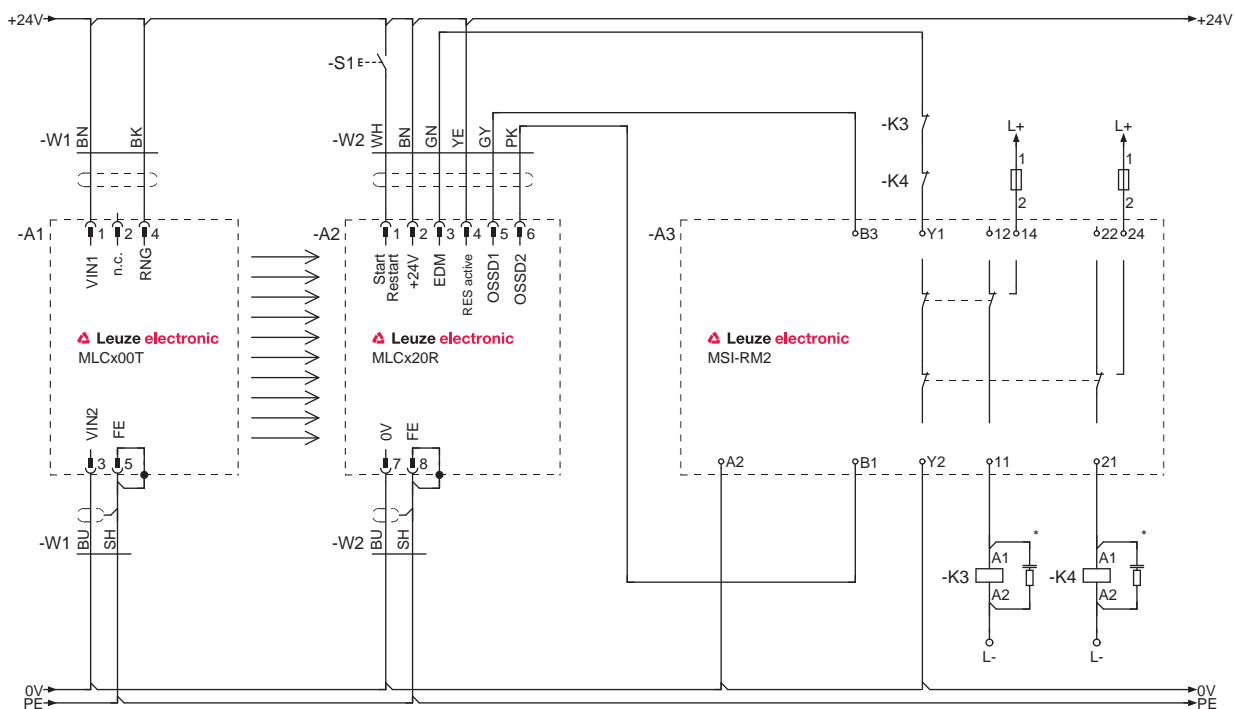



Fig. 7.4: Circuit diagram example with downstream MSI-RM2 safety relay

8 Starting up the device

|  WARNING | |
|--|---|
|  | <p>Improper use of the safety sensor may result in serious injury!</p> <ul style="list-style-type: none"> ↪ Make certain that the entire device and the integration of the optoelectronic protective device were inspected by qualified and instructed persons (see chapter 2.2 "Necessary competencies"). ↪ Make certain that a dangerous process can only be started while the safety sensor is switched on. |

Prerequisites:

- Safety sensor mounted (see chapter 6 "Mounting") and connected (see chapter 7 "Electrical connection") correctly
- Operating personnel were instructed in proper use
- Dangerous process is switched off, outputs of the safety sensor are disconnected, and the system is protected against being switched back on
- ↪ After start-up, check the function of the safety sensor (see chapter 9.1 "Before commissioning and following modifications").

8.1 Switching on

Requirements for the supply voltage (power supply unit):

- Safe mains separation is ensured.
- Current reserve of at least 2 A is available.
- The RES function is activated - either in the safety sensor or in the downstream control.
- ↪ Switch on the safety sensor.
- ⇒ The safety sensor performs a self test and then displays the response time of the receiver (see chapter 3.3.2 "Operating indicators on the MLC 320 receiver").

Check operational readiness of sensor

- ↪ Check whether LED1 is permanently lit green or red (see chapter 3.3.2 "Operating indicators on the MLC 320 receiver").
- ⇒ The safety sensor is ready for use.

8.2 Aligning the sensor

| NOTICE | |
|---|--|
|  | <p>Faulty or incorrect alignment may result in an operating fault!</p> <ul style="list-style-type: none"> ↪ The alignment performed during start-up should only be performed by qualified persons (see chapter 2.2 "Necessary competencies"). ↪ Observe the data sheets and mounting instructions of the individual components. |

Prealignment

Fasten the transmitter and receiver in a vertical or horizontal position and at the same height so that

- the front screens are directed at each other.
- the transmitter and receiver connections point in the same direction.
- the transmitter and receiver are arranged parallel to each other, i.e. they are the same distance from each other at the beginning and end of the device.

Alignment can be performed with a clear protective field by observing the LEDs and the 7-segment display (see chapter 3.3 "Display elements").

- ↪ Loosen the screws on the mounting brackets or device columns.

NOTICE

Loosen the screws only enough so that the devices can just be moved.

- ↵ Turn the receiver to the left until LED1 still flashes green but does not yet illuminate red. If necessary, you may have to turn the transmitter beforehand.
 - ⇒ The receiver with activated alignment display shows flashing segments in the 7-segment display.
- ↵ Note the value of the twist angle.
- ↵ Turn the receiver to the right until LED1 still flashes green but does not yet illuminate red.
- ↵ Note the value of the twist angle.
- ↵ Set the optimum position of the receiver. This lies in the middle of the two values for the twist angle to the left and right.
- ↵ Tighten the fastening screws of the receiver.
- ↵ Now align the transmitter according to the same method, paying attention to the display elements of the receiver while doing so (see chapter 3.3.2 "Operating indicators on the MLC 320 receiver").

NOTICE

Separate alignment aids such as the AC-ALM are also available as accessories.

8.3 Aligning of deflecting mirrors with the laser alignment aid

When using deflecting mirrors for multiple-side point of operation guarding and access guarding, an external laser alignment aid is recommended (see chapter 15 "Order guide and accessories").



NOTICE

With its clearly visible red light spot, the external laser alignment aid facilitates the correct setting of the transmitter and receiver as well as the deflecting mirrors.

- ↵ Fasten the laser alignment aid on top on the side groove of the transmitter. Mounting instructions are included in the accessories.
- ↵ Switch on the laser. Take note of the operating instructions of the laser alignment aid concerning the safety notices and the activation of the laser alignment aid.
- ↵ Loosen the mounting bracket of the transmitter and turn or tilt or pitch the device so that the laser spot strikes the top of the first deflecting mirror (see chapter 6.2.2 "Definition of directions of movement").
- ↵ Now set the laser below on the transmitter and adjust it so that the laser spot strikes the bottom of the deflecting mirror.
- ↵ Now set the laser back up top on the transmitter and check if the laser spot still strikes the top of the deflecting mirror. If it does not, the mounting height of the transmitter must be changed, if applicable.
- ↵ Repeat the process until the laser strikes the respective point of the deflecting mirror, both on top and on bottom.
- ↵ Turn, tilt or pitch the deflecting mirror so that the laser spot strikes either the next deflecting mirror or the receiver in both positions.
- ↵ Repeat the process in reverse after setting the laser alignment aid above and below on the receiver. The laser beam must strike the transmitter in both cases if the receiver has been correctly aligned.
- ↵ Remove the laser alignment aid from the safety sensor.
- ⇒ The protective field is free. LED1 on the receiver is permanently lit green. The OSSDs switch on.

8.4 Unlocking start/restart interlock

The reset button can be used to unlock the start/restart interlock. In this way, the responsible person can restore the ON state of the safety sensor following process interruptions (due to triggering of protective function, failure of the voltage supply).

| | |
|--|---|
|  WARNING | |
|  | <p>Premature unlocking of the start/restart interlock may result in serious injury!</p> <p>If the start/restart interlock is unlocked, the system can start up automatically.</p> <p>↳ Before unlocking the start/restart interlock, make certain that no people are in the danger zone.</p> |

The red LED of the receiver illuminates as long as the restart is locked (OSSDs off). The yellow LED illuminates when the protective field is free and RES is activated (ready to be unlocked).

- ↳ Make certain that the active protective field is clear.
- ↳ Make certain that there are no people in the danger zone.
- ↳ Press and release the reset button within 0.15 to 4 s. The receiver switches to the ON state.

If you keep the reset button pressed longer than 4 s:

- Starting at 4 s: the reset request is ignored.
- Starting at 30 s: a +24 V short circuit is assumed on the reset input and the receiver switches to the interlock state (see chapter 11.1 "What to do in case of failure?").

9 Testing

| NOTICE | |
|---|---|
|  | <ul style="list-style-type: none"> ↪ Safety sensors must be replaced at the end of their mission time (see chapter 14 "Technical data"). ↪ Always exchange entire safety sensors. ↪ Observe any nationally applicable regulations regarding the tests. ↪ Document all tests in a comprehensible manner and include the configuration of the safety sensor along with the data for the safety- and minimum distances in the documentation. |

9.1 Before commissioning and following modifications

|  WARNING | |
|--|--|
|  | <p>Unpredictable machine behavior during start-up may result in serious injury!</p> <ul style="list-style-type: none"> ↪ Make certain that there are no people in the danger zone. |

- ↪ Before they begin work, train the operators on their respective tasks. The training is the responsibility of the operating company.
- ↪ Attach notes regarding daily testing in the respective national language of the operator on the machine in a highly visible location, e.g. by printing out the corresponding chapter (see chapter 9.3 "Periodically by the operator").
- ↪ Test the electrical function and installation according to this document.

Acc. to IEC 62046 and national regulations (e.g. EU directive 2009/104/EC), tests are to be performed by competent persons (see chapter 2.2 "Necessary competencies") in the following situations:

- Prior to commissioning
- Following modifications to the machine
- After longer machine downtime
- Following retrofitting or new configuration of the machine

- ↪ As preparation, check the most important criteria for the safety sensor according to the following checklist (see chapter 9.1.1 "Checklist for integrator – to be performed prior to commissioning and following modifications"). Completing the checklist does not replace testing by competent persons (see chapter 2.2 "Necessary competencies")!
- ⇒ Not until proper function of the safety sensor is ascertained may it be integrated in the control circuit of the system.

9.1.1 Checklist for integrator – to be performed prior to commissioning and following modifications

| NOTICE | |
|---|--|
|  | <p>Completing the checklist does not replace testing by a qualified person (see chapter 2.2 "Necessary competencies")!</p> <ul style="list-style-type: none"> ↪ If you answer one of the items on the following check list with no, the machine must no longer be operated. ↪ IEC 62046 contains additional recommendations on testing protective devices. |

Tab. 9.1: Checklist for integrator – to be performed prior to the initial start-up and following modifications

| Check: | Yes | No | not applicable |
|--|-----|----|----------------|
| Is the safety sensor operated acc. to the specific environmental conditions that are to be maintained (see chapter 14 "Technical data")? | | | |
| Is the safety sensor correctly aligned and are all fastening screws and connectors secure? | | | |

| Check: | Yes | No | not applicable |
|--|-----|----|----------------|
| Are safety sensor, connection cables, connectors, protection caps and command devices undamaged and without any sign of manipulation? | | | |
| Does the safety sensor satisfy the required safety level (PL, SIL, category)? | | | |
| Are both safety-related switching outputs (OSSDs) integrated in the downstream machine control acc. to the required safety category? | | | |
| Are switching elements that are controlled by the safety sensor monitored according to the required safety level (PL, SIL, category) (e.g., contactors through EDM)? | | | |
| Are all points of operation near the safety sensor accessible only through the protective field of the safety sensor? | | | |
| Are the necessary additional protective devices in the immediate surroundings (e.g., safety guard) properly mounted and secured against tampering? | | | |
| If it is possible to be present undetected between the safety sensor and point of operation: is an assigned start/restart interlock functional? | | | |
| Is the command device for unlocking the start/restart interlock mounted in such a way that it cannot be reached from within the danger zone and so that the complete danger zone can be seen from the installation location? | | | |
| Has the maximum stopping time of the machine been measured and documented? | | | |
| Is the required safety distance maintained? | | | |
| Does interruption with a test object intended for this purpose cause the dangerous movement(s) to stop? | | | |
| Is the safety sensor effective during the entire dangerous movement(s)? | | | |
| Is the safety sensor effective in all relevant operating modes of the machine? | | | |
| Is start-up of dangerous movements reliably prevented if an active light beam or the protective field is interrupted with a test object intended for this purpose? | | | |
| Was the sensor detection capacity successfully tested (see chapter 9.3.1 "Checklist – periodically by the operator")? | | | |
| Were distances to reflective surfaces taken into account during configuration and no reflection bypasses subsequently detected? | | | |
| Are notices for regular testing of the safety sensor legible to the operator and are they located in a highly visible location? | | | |
| Are changes to the safety function (e.g. SPG, blanking, protective field switchover) not easy to achieve through tampering? | | | |
| Are settings that could result in an unsafe state possible only by means of key, password or tool? | | | |
| Are there incentives that pose stimulus for tampering? | | | |
| Were the operators instructed prior to starting work? | | | |

9.2 To be performed periodically by competent persons

The reliable interaction of safety sensor and machine must be regularly tested by qualified persons (see chapter 2.2 "Necessary competencies") in order to detect changes to the machine or impermissible tampering with the safety sensor.

Acc. to IEC 62046 and national regulations (e.g., EU directive 2009/104/EC), tests of elements which are subject to wear must be performed by qualified persons (see chapter 2.2 "Necessary competencies") at regular intervals. Testing intervals may be regulated by nationally applicable regulations (recommendation acc. to IEC 62046: 6 months).



- ↪ Only allow testing to be performed by qualified persons (see chapter 2.2 "Necessary competencies").
- ↪ Observe the nationally applicable regulations and the time periods specified therein.
- ↪ As preparation, observe the checklist (see chapter 9.1 "Before commissioning and following modifications").

9.3 Periodically by the operator

The function of the safety sensor must be checked depending on the given risk according to the following checklist so that damages or prohibited tampering can be detected.

Depending on the risk assessment, the test cycle must be defined by the integrator or operating company (e.g., daily, on shift changes, ...) or is specified by national regulations or regulations of the employer's liability insurance association and may be dependent on the machine type.

Due to complex machines and processes, it may be necessary under certain circumstances to check some points at longer time intervals. Observe the classification in "Test at least" and "Test when possible".

| NOTICE | |
|--|--|
|  | For larger distances between transmitter and receiver and when using deflecting mirrors, a second person may be necessary. |
|  WARNING | |
|  | <p>Unpredictable machine behavior during the test may result in serious injury!</p> <ul style="list-style-type: none"> ↪ Make certain that there are no people in the danger zone. ↪ Before they begin work, train the operators on their respective tasks and provide suitable test objects and an appropriate test instruction. |

9.3.1 Checklist – periodically by the operator

| NOTICE | |
|---|---|
|  | <p>↪ If you answer one of the items on the following check list with no, the machine must no longer be operated.</p> |

Tab. 9.2: Checklist – regular function test by trained operators/persons

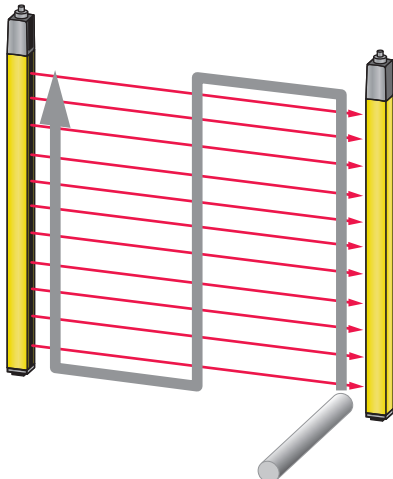
| Test at least: | Yes | No |
|--|------------|-----------|
| Are safety sensor and connectors securely mounted and free of obvious signs of damage, changes or tampering? | | |
| Were no obvious changes made to access or entry possibilities? | | |
| <p>Test the effectiveness of the safety sensor:</p> <ul style="list-style-type: none"> • The LED 1 on the safety sensor must illuminate green (see chapter 3.3.2 "Operating indicators on the MLC 320 receiver"). • Interrupt an active beam or the protective field (see figure) with a suitable, opaque test object: <div style="text-align: center;">  </div> <p>Checking the protective field function with test rod (only for safety light curtains with a resolution of 14 ... 40 mm). For light curtains with different resolution ranges, this check is to be performed separately for each resolution range.</p> <ul style="list-style-type: none"> • Does the OSSD LED on the receiver illuminate constantly red while the protective field is interrupted? | | |
| When possible, test during running operation: | Yes | No |
| Protective device with approach function: during machine operation, the protective field is interrupted with the test object – are the obviously dangerous machine parts stopped without noticeable delay? | | |
| Protective device with presence detection: the protective field is interrupted with the test object – does this prevent operation of the obviously dangerous machine parts? | | |

10 Maintenance

NOTICE



Faulty operation if transmitter and receiver are soiled!

The surfaces of the front screen of transmitters, receivers and, where applicable, deflecting mirror must not be scratched or roughened at the positions where beams enter and exit.

↳ Do not use chemical cleaners.

Prerequisites for cleaning:

- The system is safely shut down and protected against restart.

↳ Clean the safety sensor periodically depending on the degree of contamination.

NOTICE



Prevent electrostatic charging of the front screens!

↳ To clean the front screens of transmitter and receiver, use only damp cloths.

11 Troubleshooting

11.1 What to do in case of failure?

After switching the safety sensor on, the display elements (see chapter 3.3 "Display elements") assist in checking the correct functionality and in faultfinding.

In case of failure, you can determine the fault from the LED displays or read a message from the 7-segment display. With the error message you can determine the cause of the error and initiate measures to rectify it.

NOTICE



If the safety sensor responds with an error display, you will often be able to eliminate the cause yourself!

- ↪ Switch off the machine and leave it switched off.
- ↪ Analyze and eliminate the cause of the fault using the following table.
- ↪ If you are unable to rectify the fault, contact the Leuze electronic branch responsible for you or call the Leuze electronic customer service (Service and support).

11.2 Operating indicators of the LEDs

Tab. 11.1: LED indicators at the transmitter - causes and measures

| LED | State | Cause | Measure |
|------|-------|------------------------------------|---|
| LED1 | OFF | Transmitter without supply voltage | Check the power supply unit and the electrical connection. Exchange the power supply unit, if applicable. |
| | Red | Device failed | Replace the device. |

Tab. 11.2: LED indicators at the receiver - causes and measures

| LED | State | Cause | Measure |
|-----------------|---|--|---|
| LED1 | OFF | Device failed | Replace the device. |
| | Red (7-segment display during start-up: "C1" or "C2" according to the number of green LEDs on the transmitter) | Alignment incorrect or protective field interrupted | Remove all objects from the protective field. Align the transmitter and receiver to each other or place blanked objects correctly concerning size and position. |
| | Red (7-segment display during start-up: "C1". LEDs on transmitter: both green) | Receiver is set on C1, transmitter on C2 | Set the transmitter and receiver on the same transmission channel and align both correctly. |
| | Red (7-segment display during start-up: "C2". LED1 on transmitter: green) | Receiver is set on C2, transmitter on C1 | Remove all objects from the protective field. Align the transmitter and receiver to each other or place blanked objects correctly concerning size and position. |
| | Red, flashing slowly, approx. 1 Hz (7-segment display "E x y") | External error | Check the connection of the cables and the control signals. |
| | Red, flashing fast, approx. 10 Hz (7-segment display "F x y") | Internal error | If restart fails, exchange the device. |
| | Green, flashing slowly, approx. 1 Hz | Weak signal due to contamination or poor alignment | Clean the front screens and check the alignment of transmitter and receiver. |
| | LED2 | Yellow | Start/restart interlock is locked and protective field is free - ready for unlocking |
| Yellow flashing | | The control circuit is open in operating mode 1, 2 and 3 | Close the input circuit with the correct polarity and timing. |

11.3 Error messages 7-segment display

Tab. 11.3: Messages of the 7-segment display (F: internal device error, E: external error, U: usage info during application errors)

| Error | Cause/description | Measures | Sensor behavior |
|--------------|--|--|-----------------|
| F[No. 0-255] | Internal error | In the event of an unsuccessful restart, contact customer service. | |
| OFF | Very high overvoltage (± 40 V) | Supply the device with the correct voltage. | |
| E01 | Cross connection between OSSD1 and OSSD2 | Check the wiring between OSSD1 and OSSD2. | Automatic reset |
| E02 | Overload on OSSD1 | Check the wiring or exchange the connected component (reducing the load). | Automatic reset |
| E03 | Overload on OSSD2 | Check the wiring or exchange the connected component (reducing the load). | Automatic reset |
| E04 | High-impedance short circuit to VCC OSSD1 | Check the wiring. Exchange the cable, if applicable. | Automatic reset |
| E05 | High-impedance short circuit to VCC OSSD2 | Check the wiring. Exchange the cable, if applicable. | Automatic reset |
| E06 | Short circuit against GND at OSSD1 | Check the wiring. Exchange the cable, if applicable. | Automatic reset |
| E07 | Short circuit against +24 V at OSSD1 | Check the wiring. Exchange the cable, if applicable. | Automatic reset |
| E08 | Short circuit against GND at OSSD2 | Check the wiring. Exchange the cable, if applicable. | Automatic reset |
| E09 | Short circuit against +24 V at OSSD2 | Check the wiring. Exchange the cable, if applicable. | Automatic reset |
| E10, E11 | OSSD error, source unknown | Check the wiring. Exchange the cable and the receiver if necessary. | Automatic reset |
| E14 | Undervoltage ($< +15$ V) | Supply the device with the correct voltage. | Automatic reset |
| E15 | Overvoltage ($> +32$ V) | Supply the device with the correct voltage. | Automatic reset |
| E16 | Overvoltage ($> +40$ V) | Supply the device with the correct voltage. | Locking |
| E17 | Foreign transmitter detected | Remove foreign transmitters and increase the distance to the reflective surfaces. Actuate the start button if available. | Locking |
| E18 | Ambient temperature too high | Ensure correct environmental conditions | Automatic reset |
| E19 | Ambient temperature too low | Ensure correct environmental conditions | Automatic reset |
| E22 | Interference detected on plug pin 3. Signal output: output signal is not equal to the signal input read-back value: it switches simultaneously with the other signal line. | Check the wiring. | Automatic reset |

| Error | Cause/description | Measures | Sensor behavior |
|-------------|--|--|-----------------|
| E23 | Interference detected on plug pin 4. Signal output: output signal is not equal to the signal input read-back value: it switches simultaneously with the other signal line. | Check the wiring. | Automatic reset |
| E24 | Interference detected on plug pin 8. Signal output: output signal is not equal to the signal input read-back value: it switches simultaneously with the other signal line. | Check the wiring. | Automatic reset |
| E30 | EDM does not open | Actuate the start button if available. | Locking |
| E31 | EDM does not close | Actuate the start button if available. | Locking |
| E37 | EDM operating mode changed during operation | Check the correctness of the selected operating mode, correct the operating mode if required, and restart. | Locking |
| E38 | Restart interlock operating mode changed during operation | Check the correctness of the selected operating mode, correct the operating mode if required, and restart. | Locking |
| E39 | Actuation duration (2.5 min) exceeded for reset button or cable short circuited | Press the reset button. If the restart is unsuccessful, check the wiring of the reset button. | Automatic reset |
| E41 | Invalid change of operating mode due to reversal of the supply voltage polarity during operation | Check the wiring and programming of the device which controls this signal. | Locking |
| E80 ... E86 | Invalid operating mode due to setting error, general operating mode change | E.g. reset button pressed during start-up, check the circuit diagram and the wiring and restart. | Locking |
| E87 | Operating mode changed | Check the wiring. Restart the sensor. | Locking |
| E90 | Faulty connection on HOST or Middle Guest | Check connection, e.g., connect terminating plug | Locking |

12 Disposing

↳ For disposal observe the applicable national regulations regarding electronic components.

13 Service and support

Service hotline

You can find the contact information for the hotline in your country on our website www.leuze.com under **Contact & Support**.

Repair service and returns

Defective devices are repaired in our service centers competently and quickly. We offer you an extensive service packet to keep any system downtimes to a minimum. Our service center requires the following information:

- Your customer number
- Product description or part description
- Serial number and batch number
- Reason for requesting support together with a description

Please register the merchandise concerned. Simply register return of the merchandise on our website www.leuze.com under **Contact & Support > Repair Service & Returns**.

To ensure quick and easy processing of your request, we will send you a returns order with the returns address in digital form.

14 Technical data

14.1 General specifications

Tab. 14.1: Protective field data

| Physical resolution [mm] | Operating range [m] | | Protective field height [mm] | |
|--------------------------|---------------------|------|------------------------------|------|
| | min. | max. | min. | max. |
| 20 | 0 | 15 | 150 | 1800 |
| 30 | 0 | 10 | 150 | 1800 |
| 40 | 0 | 20 | 150 | 3000 |
| 90 | 0 | 20 | 450 | 3000 |

Tab. 14.2: Safety-relevant technical data

| | |
|---|---------------------------|
| Type in accordance with IEC 61496 | Type 2 |
| SIL in accordance with IEC 61508 | SIL 1 |
| SILCL in accordance with IEC 62061 | SILCL 1 |
| Performance Level (PL) in accordance with ISO 13849-1:2015 | PL c |
| Category in accordance with ISO 13849-1:2015 | Cat. 2 |
| Average probability of a failure to danger per hour (PFH _d) | 5.06x10 ⁻⁸ 1/h |
| Mission time (T _M) | 20 years |

Tab. 14.3: General system data

| | |
|--|---|
| Connection technology | M12, 5-pin (transmitter) M12, 8-pin (receiver) |
| Supply voltage U _v , transmitter and receiver | +24 V, ± 20 %, compensation necessary at 20 ms voltage dip, min. 250 mA (+ OSSD load) |
| Residual ripple of the supply voltage | ± 5 % within the limits of U _v |
| Current consumption - transmitter | 50 mA |
| Current consumption receiver | 150 mA (without load) |
| Common value for ext. fuse in the supply line for transmitter and receiver | 2 A semi time-lag |
| CULus range of validity | Connection with cables acc. to the listed R/C (CYJV2/7 or CYJV/7) cables or cables with corresponding data. |
| Synchronization | Optical between transmitter and receiver |
| Protection class | III |
| Degree of protection | IP65 |
| Ambient temperature, operation | 0 ... 55 °C |
| Ambient temperature, storage | -25 ... 70 °C |
| Relative humidity (non-condensing) | 0 ... 95 % |
| Vibration resistance | 50 m/s ² acceleration, 10 - 55 Hz in acc. with IEC 60068-2-6; 0.35 mm amplitude |
| Shock resistance | 100 m/s ² acceleration, 16 ms acc. to IEC 60068-2-6 |
| Profile cross section | 29 mm x 35.4 mm |

| | |
|------------|--|
| Dimensions | see chapter 14.3 "Dimensions, weight, response time" |
| Weight | see chapter 14.3 "Dimensions, weight, response time" |

Tab. 14.4: System data - transmitter

| | |
|-----------------------------|--|
| Light source | LED; exempt group in acc. with IEC 62471 |
| Wavelength | 940 nm |
| Pulse duration | 800 ns |
| Pulse pause | 1.9 μ s (min.) |
| Mean power | <50 μ W |
| Input current pin 4 (range) | Against +24 V: 10 mA Against 0 V: 10 mA |

NOTICE



The UL testing only includes fire and shock tests.

Tab. 14.5: System data receiver, indication signals and control signals

| Pin | Signal | Type | Electrical data |
|-----|-----------|-------------------|--|
| 1 | RES/STATE | Input: Output: | Against +24 V: 15 mA Against 0 V: 80 mA |
| 3 | EDM | Input: | Against 0 V: 15 mA |
| 4 | RES | Input: | Against 24 V: 15 mA |

Tab. 14.6: Technical data of the electronic safety-related switching outputs (OSSDs) on the receiver

| Safety-related PNP transistor outputs (short-circuit monitored, cross-circuit monitored) | Minimum | Typical | Maximum |
|--|---------|----------------------|-----------------------------|
| Class (source) | C2 | | |
| Switching voltage high active ($U_v - 1.5V$) | 18 V | 22.5 V | 27 V |
| Switching voltage low | | 0 V | +2.5 V |
| Switching current | | 300 mA | 380 mA |
| Residual current | | <2 μ A | 200 μ A ^{a)} |
| Load capacity | | | 0.3 μ F |
| Load inductivity | | | 2 H |
| Permissible wire resistance for load | | | <200 Ω ^{b)} |
| Permissible wire cross section | | 0.25 mm ² | |
| Permissible cable length between receiver and load | | | 100 m |
| Test pulse width | | 60 μ s | 340 μ s |
| Test pulse distance | (5 ms) | 60 ms | |
| OSSD restart delay time after beam interruption | | 100 ms | |

a) In the event of a failure (if the 0 V cable is interrupted), each of the outputs behaves as a 120 kΩ resistor to U_v. A downstream safety PLC must not detect this as a logical "1".

b) Note the additional restrictions due to cable length and load current.

| NOTICE | |
|---|---|
|  | The safety-related transistor outputs perform the spark extinction. With transistor outputs, it is therefore neither necessary nor permitted to use the spark extinction circuits recommended by contactor or valve manufacturers (RC elements, varistors or recovery diodes), since these considerably extend the decay times of inductive switching elements. |

Tab. 14.7: Patents

| | |
|------------|----------------|
| US patents | US 6,418,546 B |
|------------|----------------|

14.2 Electromagnetic compatibility

The device corresponds to CISPR 11/ EN 55011 Group 1 and Class B.

- Group 1: All devices that do not belong to Group 2 (lab equipment, devices for industrial process measurement and control).
- Group 2: All devices that intentionally generate HF energy for material processing / modification (microwave and induction ovens, electric welding equipment).
- Class A: Industrial systems in which the 230 V supply network is provided by means of a separate transformer (from medium voltage).
- Class B: Commercial, industrial locations and residential areas that are supplied by the public 230 V network (low-voltage network) or are connected to it.

14.3 Dimensions, weight, response time

Dimensions, weight and response time are dependent on

- the resolution
- the length

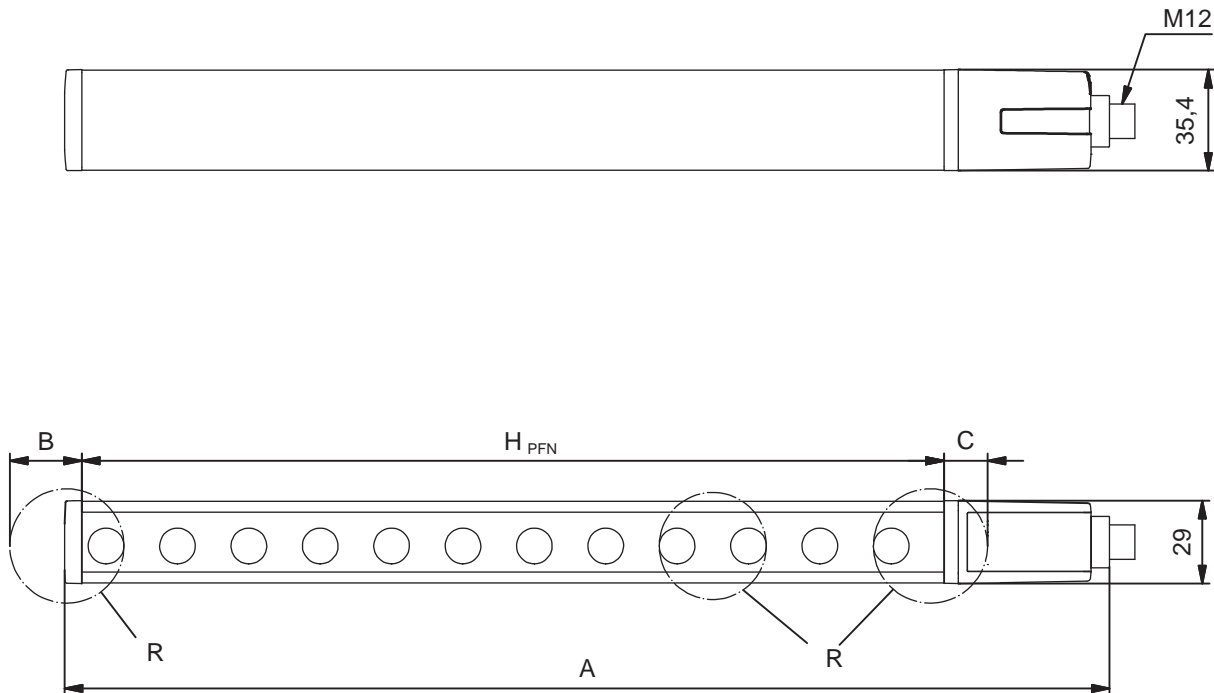

Fig. 14.1: Dimensions of transmitter and receiver

Effective protective field height H_{PFE} goes beyond the dimensions of the optics area to the outer borders of the circles labeled with R.

Calculation of the effective protective field height

$$H_{PFE} = H_{PFN} + B + C$$

- H_{PFE} [mm] = Effective protective field height
- H_{PFN} [mm] = Rated protective field height, this corresponds to the length of the yellow housing part (see tables below)
- A [mm] = Total height
- B [mm] = Additional dimensions for calculation of the effective protective field height (see table below)
- C [mm] = Value for calculating the effective protective field height (see tables below)

Tab. 14.8: Dimensions (nominal protective field height), weight and response time

| Device type | Transmitter and receiver | | | Receiver | | | |
|-------------|--------------------------|------|-------------|---------------------------------------|-------|-------|-------|
| | Dimensions [mm] | | Weight [kg] | Response time [ms] acc. to resolution | | | |
| Type | H _{PFN} | A | | 20 mm | 30 mm | 40 mm | 90 mm |
| MLC...-150 | 150 | 216 | 0.30 | 4 | 3 | 3 | - |
| MLC...-225 | 225 | 291 | 0.37 | 5 | 3 | 3 | - |
| MLC...-300 | 300 | 366 | 0.45 | 7 | 4 | 4 | - |
| MLC...-450 | 450 | 516 | 0.60 | 9 | 5 | 5 | 3 |
| MLC...-600 | 600 | 666 | 0.75 | 12 | 7 | 7 | 3 |
| MLC...-750 | 750 | 816 | 0.90 | 14 | 8 | 8 | 4 |
| MLC...-900 | 900 | 966 | 1.05 | 17 | 9 | 9 | 4 |
| MLC...-1050 | 1050 | 1116 | 1.20 | 19 | 10 | 10 | 4 |
| MLC...-1200 | 1200 | 1266 | 1.35 | 22 | 12 | 12 | 5 |
| MLC...-1350 | 1350 | 1416 | 1.50 | 24 | 13 | 13 | 5 |
| MLC...-1500 | 1500 | 1566 | 1.65 | 26 | 14 | 14 | 6 |
| MLC...-1650 | 1650 | 1716 | 1.80 | 29 | 15 | 15 | 6 |
| MLC...-1800 | 1800 | 1866 | 1.95 | 31 | 17 | 17 | 7 |
| MLC...-1950 | 1950 | 2016 | 2.10 | 34 | 18 | 18 | 7 |
| MLC...-2100 | 2100 | 2166 | 2.25 | 36 | 19 | 19 | 7 |
| MLC...-2400 | 2400 | 2466 | 2.55 | 41 | 22 | 22 | 8 |
| MLC...-2700 | 2700 | 2766 | 2.85 | 46 | 24 | 24 | 9 |
| MLC...-3000 | 3000 | 3066 | 3.15 | 51 | 26 | 26 | 10 |

Tab. 14.9: Additional dimensions for calculating the effective protective field height

| R = resolution | B | C |
|----------------|-------|-------|
| 20 mm | 7 mm | 10 mm |
| 30 mm | 19 mm | 9 mm |
| 40 mm | 25 mm | 15 mm |
| 90 mm | 50 mm | 40 mm |

14.4 Dimensioned drawings: Accessories

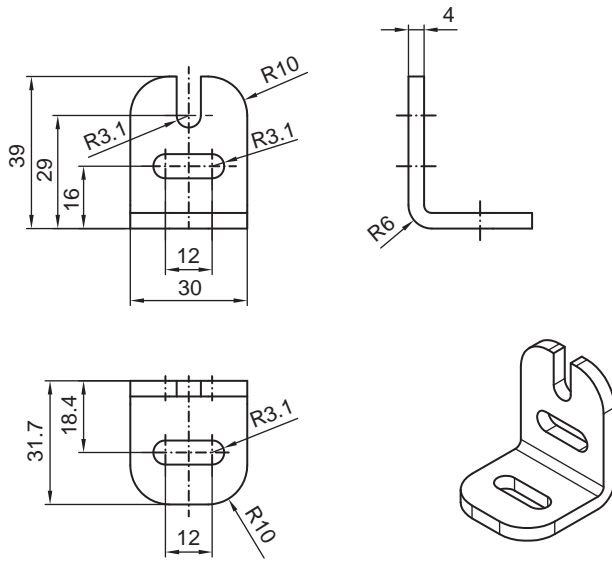

Fig. 14.2: BT-L mounting bracket

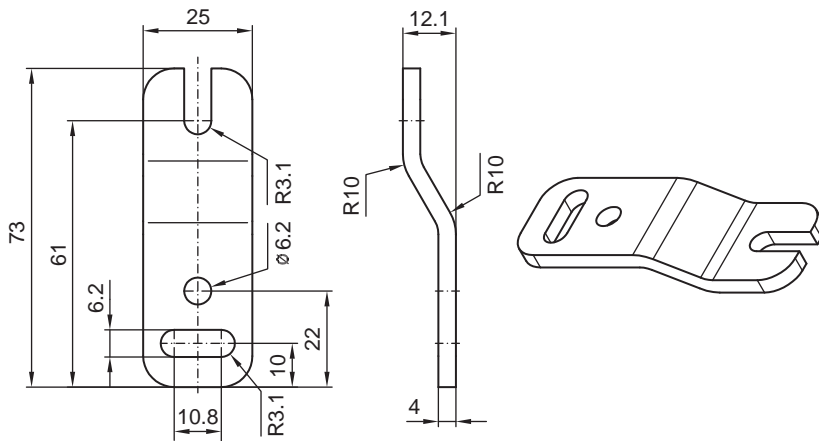

Fig. 14.3: BT-Z parallel bracket

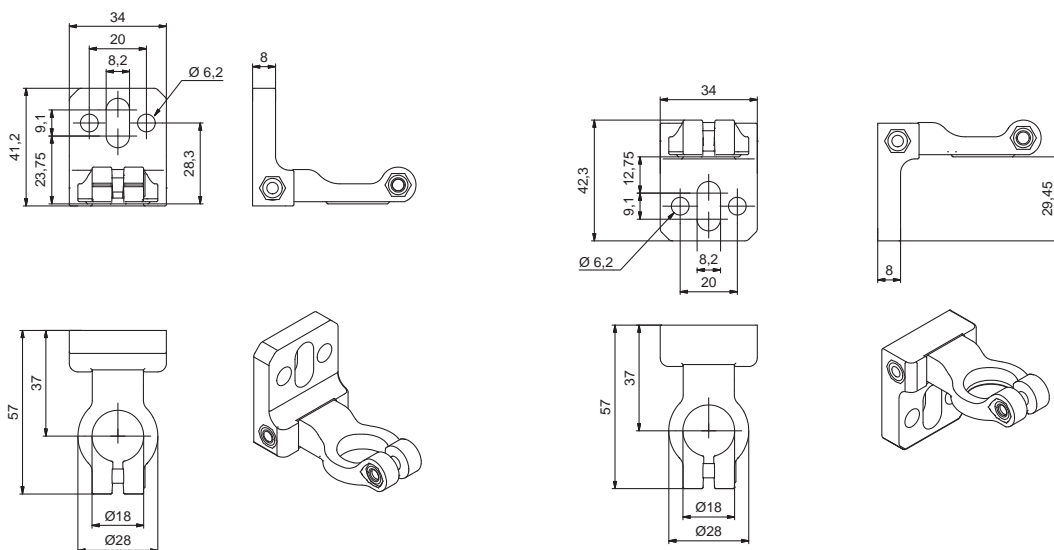

Fig. 14.4: Swivel mount BT-2HF

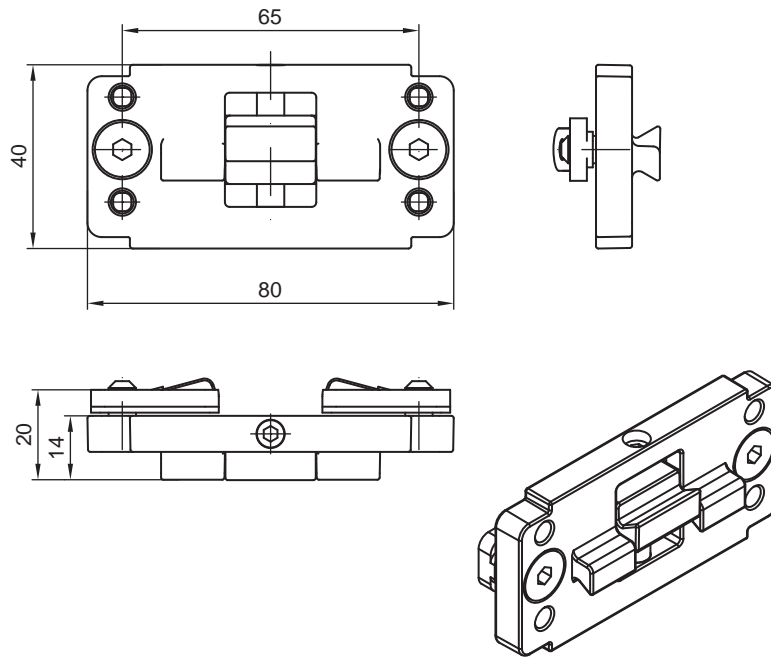

Fig. 14.5: BT-P40 clamp bracket for mounting in UDC device columns

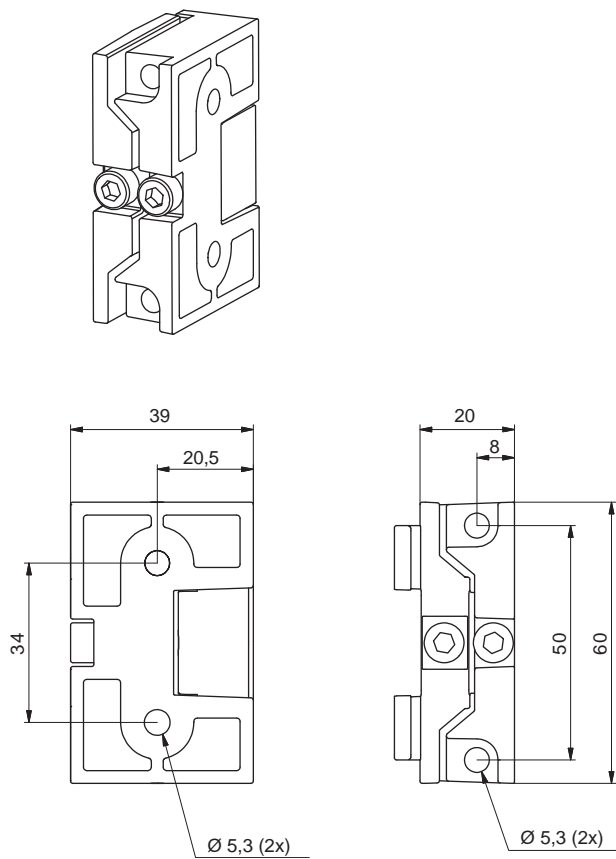

Fig. 14.6: Swiveling mounting bracket BT-2SB10

15 Order guide and accessories

Nomenclature

Part designation:

MLCxyy-za-hhhhei-ooo

Tab. 15.1: Part number code

| MLC | Safety sensor |
|------|---|
| x | Series: 3 for MLC 300 |
| x | Series: 5 for MLC 500 |
| yy | Function classes: 00: Transmitter 01: transmitter (AIDA) 02: Transmitter with test input 10: Basic receiver - automatic restart 11: basic receiver - automatic restart (AIDA) 20: Standard receiver - EDM/RES selectable 30: Extended receiver - blanking/muting |
| z | Device type: T: transmitter R: receiver |
| a | Resolution: 14: 14 mm 20: 20 mm 30: 30 mm 40: 40 mm 90: 90 mm |
| hhhh | Protective field height: 150 ... 3000: from 150 mm to 3000 mm |
| e | Host/Guest (optional): H: Host MG: Middle Guest G: Guest |
| i | Interface (optional): /A: AS-i |
| ooo | Option: EX2: explosion protection (zones 2 + 22) /V: high Vibration-proof SPG: Smart Process Gating |

Tab. 15.2: Part descriptions, examples

| Examples for part designation | Properties |
|-------------------------------|--|
| MLC300T20-600 | Type 2 transmitter, PL c, SIL 1, resolution 20 mm, protective field height 600 mm |
| MLC300T30-900 | Type 2 transmitter, PL c, SIL 1, resolution 30 mm, protective field height 900 mm |
| MLC320R90-1500 | Type 2 Standard receiver, PL c, SIL 1, resolution 90 mm, protective field height 1500 mm |

Scope of delivery

- Transmitter including 2 sliding blocks, 1 instruction sheet
- Receiver including 2 sliding blocks, 1 self-adhesive notice sign "Important notices and notices for the machine operator", 1 set of connecting and operating instructions (PDF file on CD-ROM)

Tab. 15.3: Part numbers of MLC 300 transmitter depending on resolution and protective field height

| Protective field height hhhh [mm] | 20 mm MLC300T20-hhhh | 30 mm MLC300T30-hhhh | 40 mm MLC300T40-hhhh | 90 mm MLC300T90-hhhh |
|-----------------------------------|-------------------------|-------------------------|-------------------------|-------------------------|
| 150 | 68090201 | 68090301 | 68090401 | - |
| 225 | 68090202 | 68090302 | 68090402 | - |
| 300 | 68090203 | 68090303 | 68090403 | - |
| 450 | 68090204 | 68090304 | 68090404 | 68090904 |
| 600 | 68090206 | 68090306 | 68090406 | 68090906 |
| 750 | 68090207 | 68090307 | 68090407 | 68090907 |
| 900 | 68090209 | 68090309 | 68090409 | 68090909 |
| 1050 | 68090210 | 68090310 | 68090410 | 68090910 |
| 1200 | 68090212 | 68090312 | 68090412 | 68090912 |
| 1350 | 68090213 | 68090313 | 68090413 | 68090913 |
| 1500 | 68090215 | 68090315 | 68090415 | 68090915 |
| 1650 | 68090216 | 68090316 | 68090416 | 68090916 |
| 1800 | 68090218 | 68090318 | 68090418 | 68090918 |
| 1950 | - | - | 68090419 | 68090919 |
| 2100 | - | 68090321 | 68090421 | 68090921 |
| 2400 | - | - | 68090424 | 68090924 |
| 2700 | - | - | 68090427 | 68090927 |
| 3000 | - | - | 68090430 | 68090930 |

Tab. 15.4: Part numbers of MLC 320 receiver depending on resolution and protective field height

| Protective field height hhhh [mm] | 20 mm MLC320R20-hhhh | 30 mm MLC320R30-hhhh | 40 mm MLC320R40-hhhh | 90 mm MLC320R90-hhhh |
|-----------------------------------|-------------------------|-------------------------|-------------------------|-------------------------|
| 150 | 68092201 | 68092301 | 68092401 | - |
| 225 | 68092202 | 68092302 | 68092402 | - |
| 300 | 68092203 | 68092303 | 68092403 | - |
| 450 | 68092204 | 68092304 | 68092404 | 68092904 |
| 600 | 68092206 | 68092306 | 68092406 | 68092906 |
| 750 | 68092207 | 68092307 | 68092407 | 68092907 |
| 900 | 68092209 | 68092309 | 68092409 | 68092909 |
| 1050 | 68092210 | 68092310 | 68092410 | 68092910 |
| 1200 | 68092212 | 68092312 | 68092412 | 68092912 |
| 1350 | 68092213 | 68092313 | 68092413 | 68092913 |
| 1500 | 68092215 | 68092315 | 68092415 | 68092915 |
| 1650 | 68092216 | 68092316 | 68092416 | 68092916 |
| 1800 | 68092218 | 68092318 | 68092418 | 68092918 |
| 1950 | - | - | 68092419 | 68092919 |
| 2100 | - | - | 68092421 | 68092921 |
| 2400 | - | - | 68092424 | 68092924 |
| 2700 | - | - | 68092427 | 68092927 |
| 3000 | - | - | 68092430 | 68092930 |

Tab. 15.5: Accessories

| Part no. | Article | Description |
|--|--------------------|------------------------------------|
| Connection cables for MLC 300 transmitter, shielded | | |
| 50133860 | KD S-M12-5A-P1-050 | Connection cable, 5-pin, 5 m long |
| 50133861 | KD S-M12-5A-P1-100 | Connection cable, 5-pin, 10 m long |
| 678057 | CB-M12-15000E-5GF | Connection cable, 5-pin, 15 m long |
| 678058 | CB-M12-25000E-5GF | Connection cable, 5-pin, 25 m long |
| 50137013 | KD S-M12-5A-P1-500 | Connection cable, 5-pin, 50 m long |
| Connection cables for MLC 300 transmitter, unshielded | | |
| 50133841 | KD U-M12-5A-P1-050 | Connection cable, 5-pin, 5 m long |
| 50132534 | KD U-M12-5A-P1-100 | Connection cable, 5-pin, 10 m long |
| 429088 | CB-M12-15000-5GF | Connection cable, 5-pin, 15 m long |
| 429089 | CB-M12-25000-5GF | Connection cable, 5-pin, 25 m long |
| 429281 | CB-M12-50000-5GF | Connection cable, 5-pin, 50 m long |
| Connection cables for MLC 320 receiver, shielded | | |
| 50135128 | KD S-M12-8A-P1-050 | Connection cable, 8-pin, 5 m long |
| 50135129 | KD S-M12-8A-P1-100 | Connection cable, 8-pin, 10 m long |
| 50135130 | KD S-M12-8A-P1-150 | Connection cable, 8-pin, 15 m long |
| 50135131 | KD S-M12-8A-P1-250 | Connection cable, 8-pin, 25 m long |
| 50135132 | KD S-M12-8A-P1-500 | Connection cable, 8-pin, 50 m long |

| Part no. | Article | Description |
|---|--------------------|--|
| Connection cables for MLC 320 receiver, unshielded | | |
| 50135122 | KD U-M12-8A-P1-050 | Connection cable, 8-pin, 5 m long |
| 50135123 | KD U-M12-8A-P1-100 | Connection cable, 8-pin, 10 m long |
| 50135124 | KD U-M12-8A-P1-150 | Connection cable, 8-pin, 15 m long |
| 429288 | CB-M12-25000-8GF | Connection cable, 8-pin, 25 m long |
| 429289 | CB-M12-50000-8GF | Connection cable, 8-pin, 50 m long |
| User-configurable connectors for MLC 300 transmitter | | |
| 429175 | CB-M12-5GF | Cable socket, 5-pin, metal housing, shield on housing |
| User-configurable connectors for MLC 320 receiver | | |
| 429178 | CB-M12-8GF | Cable socket, 8-pin, metal housing, shield on housing |
| Mounting technology | | |
| 429056 | BT-2L | L mounting bracket, 2x |
| 429057 | BT-2Z | Z mounting bracket, 2x |
| 429393 | BT-2HF | 360° swivel mount, 2x incl. 1 MLC cylinder |
| 429394 | BT-2HF-S | 360° swivel mount, vibration-damped, 2x incl. 1 MLC cylinder |
| 424417 | BT-2P40 | Mounting set, consisting of 2x BT-P40 clamp brackets, for mounting in UDC-S2 device column |
| 424422 | BT-2SB10 | Swiveling mounting bracket for groove mounting, $\pm 8^\circ$, 2x |
| 424423 | BT-2SB10-S | Swiveling mounting bracket for groove mounting, $\pm 8^\circ$, vibration damped, 2x |
| 425740 | BT-10NC60 | Sliding block with M6 thread, 10 x |
| 425741 | BT-10NC64 | Sliding block with M6 and M4 thread, 10 x |
| 425742 | BT-10NC65 | Sliding block with M6 and M5 thread, 10 x |
| Device columns | | |
| 549855 | UDC-900-S2 | Device column, U-shaped, profile height 900 mm |
| 549856 | UDC-1000-S2 | Device column, U-shaped, profile height 1000 mm |
| 549852 | UDC-1300-S2 | Device column, U-shaped, profile height 1300 mm |
| 549853 | UDC-1600-S2 | Device column, U-shaped, profile height 1600 mm |
| 549854 | UDC-1900-S2 | Device column, U-shaped, profile height 1900 mm |
| 549857 | UDC-2500-S2 | Device column, U-shaped, profile height 2500 mm |
| Deflecting mirror columns | | |
| 549780 | UMC-1000-S2 | Continuous deflecting mirror column 1000 mm |
| 549781 | UMC-1300-S2 | Continuous deflecting mirror column 1300 mm |
| 549782 | UMC-1600-S2 | Continuous deflecting mirror column 1600 mm |
| 549783 | UMC-1900-S2 | Continuous deflecting mirror column 1900 mm |

| Part no. | Article | Description |
|-----------------------------|------------|---|
| Deflecting mirror | | |
| 529601 | UM60-150 | Deflecting mirror, mirror length 210 mm |
| 529603 | UM60-300 | Deflecting mirror, mirror length 360 mm |
| 529604 | UM60-450 | Deflecting mirror, mirror length 510 mm |
| 529606 | UM60-600 | Deflecting mirror, mirror length 660 mm |
| 529607 | UM60-750 | Deflecting mirror, mirror length 810 mm |
| 529609 | UM60-900 | Deflecting mirror, mirror length 960 mm |
| 529610 | UM60-1050 | Deflecting mirror, mirror length 1110 mm |
| 529612 | UM60-1200 | Deflecting mirror, mirror length 1260 mm |
| 529613 | UM60-1350 | Deflecting mirror, mirror length 1410 mm |
| 529615 | UM60-1500 | Deflecting mirror, mirror length 1560 mm |
| 529616 | UM60-1650 | Deflecting mirror, mirror length 1710 mm |
| 529618 | UM60-1800 | Deflecting mirror, mirror length 1860 mm |
| 430105 | BT-2UM60 | Mounting bracket for UM60, 2x |
| Protective screens | | |
| 347070 | MLC-PS150 | Protective screen, length 148 mm |
| 347071 | MLC-PS225 | Protective screen, length 223 mm |
| 347072 | MLC-PS300 | Protective screen, length 298 mm |
| 347073 | MLC-PS450 | Protective screen, length 448 mm |
| 347074 | MLC-PS600 | Protective screen, length 598 mm |
| 347075 | MLC-PS750 | Protective screen, length 748 mm |
| 347076 | MLC-PS900 | Protective screen, length 898 mm |
| 347077 | MLC-PS1050 | Protective screen, length 1048 mm |
| 347078 | MLC-PS1200 | Protective screen, length 1198 mm |
| 347079 | MLC-PS1350 | Protective screen, length 1348 mm |
| 347080 | MLC-PS1500 | Protective screen, length 1498 mm |
| 347081 | MLC-PS1650 | Protective screen, length 1648 mm |
| 347082 | MLC-PS1800 | Protective screen, length 1798 mm |
| 429038 | MLC-2PSF | Mounting device for MLC protective screen, 2 x |
| 429039 | MLC-3PSF | Mounting device for MLC protective screen, 3 x |
| Laser alignment aids | | |
| 560020 | LA-78U | External laser alignment aid |
| 520004 | LA-78UDC | External laser alignment aid for fastening in Device Column |
| 520101 | AC-ALM-M | Alignment aid |
| Test rods | | |
| 349945 | AC-TR14/30 | Test rod 14/30 mm |
| 349939 | AC-TR20/40 | Test rod 20/40 mm |

16 EC Declaration of Conformity

The safety light curtains of the MLC series have been developed and manufactured in accordance with the applicable European standards and directives.

| NOTICE | |
|---|--|
|  | <p>You can download the EC Declaration of Conformity from the Leuze website.</p> <ul style="list-style-type: none">↳ Call up the Leuze website: www.leuze.com.↳ Enter the type designation or part number of the device as the search term. The part number can be found on the name plate of the device under the "Part No." entry.↳ The documents can be found on the product page for the device under the <i>Downloads</i> tab. |