

Technical data sheet

Throughbeam photoelectric sensor transmitter

Part no.: 50144558

LS318BI/9D-200-M12

Contents

- Technical data
- Dimensioned drawings
- Electrical connection
- Diagrams
- Operation and display
- Suitable receivers
- Part number code
- Notes
- Further information
- Accessories



For illustration purposes only



Technical data

Basic data

| | |
|---------------------|-----------------------|
| Series | 318B |
| Operating principle | Throughbeam principle |
| Device type | Transmitter |

Special version

| | |
|-----------------|--------------------|
| Special version | Deactivation input |
|-----------------|--------------------|

Optical data

| | |
|--------------------------|--------------------------------------|
| Operating range | 0 ... 16 m |
| Operating range | Guaranteed operating range |
| Operating range limit | 0 ... 23 m |
| Operating range limit | Typical operating range |
| Light source | LED, Infrared |
| Wavelength | 850 nm |
| Transmitted-signal shape | Pulsed |
| LED group | Exempt group (in acc. with EN 62471) |

Electrical data

| | |
|--------------------|------------------------------|
| Protective circuit | Polarity reversal protection |
| | Short circuit protected |

Performance data

| | |
|----------------------|--|
| Supply voltage U_B | 10 ... 30 V, DC, Incl. residual ripple |
| Residual ripple | 0 ... 15 %, From U_B |
| Open-circuit current | 0 ... 15 mA |

Inputs

| | |
|-------------------------------|------------|
| Number of deactivation inputs | 2 Piece(s) |
|-------------------------------|------------|

Deactivation inputs

Deactivation input 1

| | |
|------------------------|-----|
| Active switching state | Low |
|------------------------|-----|

Deactivation input 2

| | |
|------------------------|------|
| Active switching state | High |
|------------------------|------|

Time behavior

| | |
|-----------------|--------|
| Readiness delay | 300 ms |
|-----------------|--------|

Connection

Connection 1

| | |
|----------------------|----------------------|
| Function | Signal IN |
| | Voltage supply |
| Type of connection | Cable with connector |
| Cable length | 200 mm |
| Sheathing material | PUR |
| Cable color | Black |
| Number of conductors | 4 -wire |
| Wire cross section | 0.2 mm ² |
| Thread size | M12 |
| Type | Male |
| Material | Plastic |
| No. of pins | 4 -pin |
| Encoding | A-coded |

Mechanical data

| | |
|---------------------|---------------|
| Dimension (Ø x L) | 18 mm x 46 mm |
| Thread size | M18 x 1 mm |
| Housing material | Plastic |
| Plastic housing | ABS |
| Lens cover material | Plastic |
| Net weight | 20 g |
| Housing color | Black |
| | Red |

Operation and display

| | |
|-----------------|------------|
| Type of display | LED |
| Number of LEDs | 1 Piece(s) |

Environmental data

| | |
|--------------------------------|---------------|
| Ambient temperature, operation | -40 ... 50 °C |
| Ambient temperature, storage | -40 ... 70 °C |

Certifications

| | |
|----------------------|---------------|
| Degree of protection | IP 67 |
| Protection class | III |
| Approvals | c UL US |
| Standards applied | IEC 60947-5-2 |

Classification

| | |
|-----------------------|----------|
| Customs tariff number | 85365019 |
| ECLASS 5.1.4 | 27270901 |
| ECLASS 8.0 | 27270901 |
| ECLASS 9.0 | 27270901 |
| ECLASS 10.0 | 27270901 |
| ECLASS 11.0 | 27270901 |
| ECLASS 12.0 | 27270901 |
| ECLASS 13.0 | 27270901 |
| ECLASS 14.0 | 27270901 |
| ECLASS 15.0 | 27270901 |
| ETIM 5.0 | EC002716 |
| ETIM 6.0 | EC002716 |
| ETIM 7.0 | EC002716 |
| ETIM 8.0 | EC002716 |
| ETIM 9.0 | EC002716 |
| ETIM 10.0 | EC002716 |

Dimensioned drawings

All dimensions in millimeters

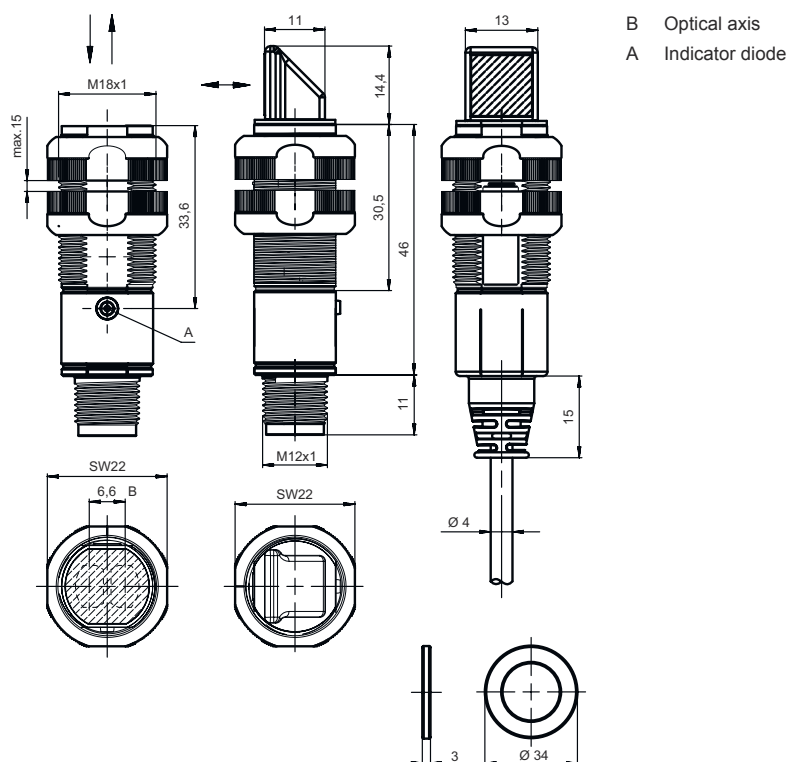

Electrical connection

Connection 1

| | |
|----------------------|-----------------------------|
| Function | Signal IN Voltage supply |
| Type of connection | Cable with connector |
| Cable length | 200 mm |
| Sheathing material | PUR |
| Cable color | Black |
| Number of conductors | 4 -wire |
| Wire cross section | 0.2 mm ² |
| Thread size | M12 |
| Type | Male |
| Material | Plastic |
| No. of pins | 4 -pin |
| Encoding | A-coded |

| Pin | Pin assignment |
|-----|----------------|
| 1 | V+ |
| 2 | IN2 |
| 3 | GND |
| 4 | IN1 |

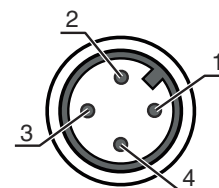

Diagrams

Typ. response behavior

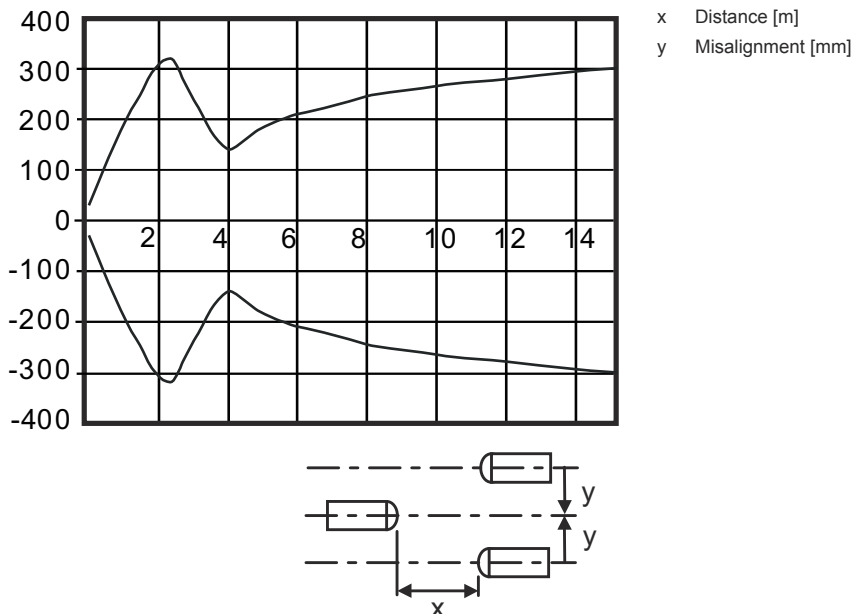

Operation and display

| LED | Display | Meaning |
|-----|--------------------------|-------------------------|
| 1 | Green, continuous light | Operational readiness |
| | Yellow, continuous light | Transmitted beam active |

Suitable receivers

| Part no. | Designation | Article | Description |
|----------|-------------------|---|---|
| 50144559 | LE318B/4P-200-M12 | Throughbeam photoelectric sensor receiver | Operating range limit: 0 ... 15 m Supply voltage: DC Digital switching outputs: 2 Piece(s) Switching output 1: Transistor, PNP, Light switching Switching output 2: Transistor, PNP, Dark switching Switching frequency: 500 Hz Connection: Cable with connector, 200 mm, M12, Plastic, 4 -wire, 4 -pin |

Part number code

Part designation: **XXX318BY-AAAF.BB/CC-DDD**

| | |
|----------------|--|
| XXX318B | Operating principle PRK: Retro-reflective photoelectric sensor with polarization filter ET: energetic diffuse reflection sensor FT: diffuse reflection sensor with fading LE: Throughbeam photoelectric sensor receiver LS: throughbeam photoelectric sensor transmitter |
| Y | Light type n/a: red light I: infrared light |
| AAAF | Preset range (optional) n/a: operating range acc. to data sheet xxxF: Preset range [mm] |

Part number code

| | |
|------------|--|
| BB | Equipment n/a: axial optics W: 90° angular optics 3: teach-in via button X: reinforced fading |
| CC | Switching output / function (OUT1 = pin 4, OUT2 = pin 2): 4: PNP transistor output, light switching P: PNP transistor output, dark switching 2: NPN transistor output, light switching N: NPN transistor output, dark switching 9: input for transmitter deactivation (deactivation with HIGH signal) D: Input for transmitter deactivation (deactivation with LOW signal) X: pin not used |
| DDD | Electrical connection n/a: cable, standard length 2000 mm, 4-wire M12: M12 connector, 4-pin (plug) 5000: cable, standard length 5000 mm, 4-wire 200-M12: cable, length 200 mm with M12 connector, 4-pin, axial (plug) |

Note



A list with all available device types can be found on the Leuze website at www.leuze.com.

Notes



Observe intended use!



- ⌘ This product is not a safety sensor and is not intended as personnel protection.
- ⌘ The product may only be put into operation by competent persons.
- ⌘ Only use the product in accordance with its intended use.

For UL applications:





- ⌘ For UL applications, use is only permitted in Class 2 circuits in accordance with the NEC (National Electric Code).
- ⌘ These proximity switches shall be used with UL Listed Cable assemblies rated 30V, 0.5A min, in the field installation, or equivalent (categories: CYJV/ CYJV7 or PVVA/PVVA7)

Further information

- Sum of the output currents for both outputs, 50 mA for ambient temperatures > 40 °C

Accessories

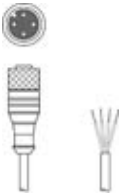
Connection technology - Connection cables

| | Part no. | Designation | Article | Description |
|---|----------|--------------------|------------------|--|
|  | 50130652 | KD U-M12-4A-V1-050 | Connection cable | Connection 1: Connector, M12, Axial, Female, A-coded, 4 -pin Connector, LED: No Connection 2: Open end Shielded: No Cable length: 5.000 mm Sheathing material: PVC |
|  | 50130690 | KD U-M12-4W-V1-050 | Connection cable | Connection 1: Connector, M12, Angled, Female, A-coded, 4 -pin Connector, LED: No Connection 2: Open end Shielded: No Cable length: 5.000 mm Sheathing material: PVC |

Mounting technology - Mounting brackets

| | Part no. | Designation | Article | Description |
|--|----------|-------------|------------------|--|
|  | 50113548 | BT D18M.5 | Mounting bracket | Diameter, inner: 18 mm Design of mounting device: Angle, L-shape Fastening, at system: Through-hole mounting Mounting bracket, at device: Screw type Type of mounting device: Rigid Material: Stainless steel |

Mounting technology - Rod mounts

| | Part no. | Designation | Article | Description |
|---|----------|--------------|-----------------|--|
|  | 50117490 | BTU D18M-D12 | Mounting system | Design of mounting device: Mounting system Fastening, at system: Through-hole mounting Mounting bracket, at device: Screw type Type of mounting device: Clampable, Adjustable, Turning, 360° Material: Metal |

Note



A list with all available accessories can be found on the Leuze website in the Download tab of the article detailed page.