

Technical data sheet Safety light curtain receiver

Part no.: 68023316

MLC520R30-1650MG



Contents

- Technical data
- Dimensioned drawings
- Electrical connection
- Suitable transmitters
- Part number code
- Notes
- Accessories



Technical data

Basic data

Series	MLC 500
Device type	Receiver
Cascading	Middle Guest
Contains	2x BT-NC sliding block
Application	Hand protection

Characteristic parameters

Type	4, IEC/EN 61496
SIL	3, IEC 61508
SILCL	3, IEC/EN 62061
Performance Level (PL)	e, EN ISO 13849-1
Mission time T _M	20 years, EN ISO 13849-1
Category	4, EN ISO 13849

Protective field data

Resolution	30 mm
Protective field height	1,650 mm

Optical data

Number of beams	66 Piece(s)
-----------------	-------------

Time behavior

Response time	14 ms, plus response times of the Host/ Guest devices
---------------	---

Connection

Number of connections	2 Piece(s)
-----------------------	------------

Connection 1

Function	Cascade, Host In
Type of connection	Cable with connector
Cable length	330 mm
Sheathing material	PUR
Thread size	M12
Material	Plastic
No. of pins	8 -pin

Connection 2

Function	Cascade, Guest Out
Type of connection	Cable with connector
Cable length	330 mm
Sheathing material	PUR
Thread size	M12
Material	Plastic
No. of pins	8 -pin

Mechanical data

Dimension (W x H x L)	29 mm x 1,664 mm x 53 mm
Housing material	Metal
Metal housing	Aluminum
Lens cover material	Plastic / PMMA
Material of end caps	Diecast zinc
Net weight	1,848 g
Housing color	Yellow, RAL 1021
Type of fastening	Groove mounting Mounting brackets Swivel mount

Environmental data

Ambient temperature, operation	0 ... 55 °C
Ambient temperature, storage	-30 ... 70 °C
Relative humidity (non-condensing)	0 ... 95 %

Certifications

Degree of protection	IP 65
Protection class	III
Certifications	c TÜV NRTL US c UL US TÜV Süd
Vibration resistance	50 m/s ²
Shock resistance	100 m/s ²
US patents	US 6,418,546 B

Classification

Customs tariff number	85365019
ECLASS 5.1.4	27272704
ECLASS 8.0	27272704
ECLASS 9.0	27272704
ECLASS 10.0	27272704
ECLASS 11.0	27272704
ECLASS 12.0	27272704
ECLASS 13.0	27272704
ECLASS 14.0	27272704
ETIM 5.0	EC002549
ETIM 6.0	EC002549
ETIM 7.0	EC002549
ETIM 8.0	EC002549
ETIM 9.0	EC002549

Dimensioned drawings

All dimensions in millimeters

Calculation of the effective protective field height $H_{PFE} = H_{PFN} + B + C$

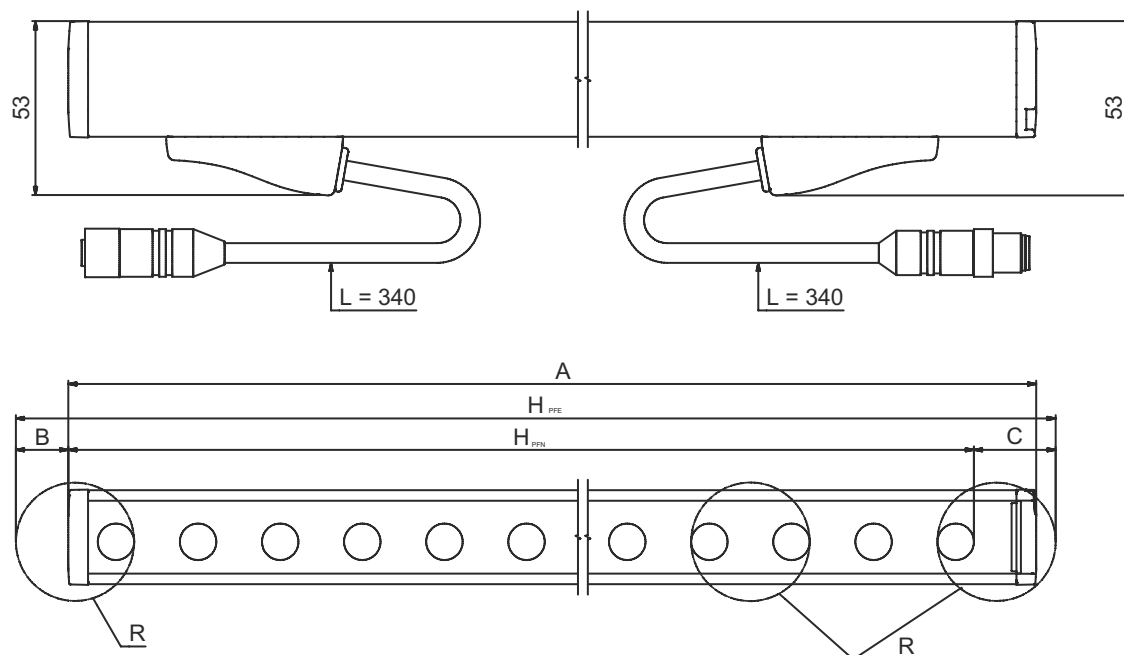

H_{PFE} Effective protective field height = 1678 mm

H_{PFN} Nominal protective field height = 1650 mm

A Total height = 1664 mm

B 19 mm

C 9 mm

R Effective protective field height H_{PFE} goes beyond the dimensions of the optics area to the outer borders of the circles labeled with R.

Electrical connection

Connection 1

Function	Cascade, Host In
Type of connection	Cable with connector
Cable length	330 mm
Sheathing material	PUR
Cable color	Black
Type of stranding	Pair stranding (twisted pair)
Wire cross section	0.14 mm ²
Thread size	M12
Type	Male
Material	Plastic
No. of pins	8 -pin
Encoding	A-coded

Connection 2

Function	Cascade, Guest Out
Type of connection	Cable with connector
Cable length	330 mm
Sheathing material	PUR
Cable color	Black
Wire cross section	0.14 mm ²

Electrical connection

Connection 2

Type of stranding	Pair stranding (twisted pair)
Thread size	M12
Type	Female
Material	Plastic
No. of pins	8 -pin
Encoding	A-coded

Suitable transmitters

	Part no.	Designation	Article	Description
	68022316	MLC500T30-1650MG	Safety light curtain transmitter	Resolution: 30 mm Protective field height: 1,650 mm Operating range: 0 ... 10 m Connection: Cable with connector, M12, Plastic, 8 -pin, 330 mm, PUR

Part number code

Part designation: MLCxyy-za-hhhhei-ooo

MLC **Safety light curtain**

x	Series 3: MLC 300 5: MLC 500
yy	Function classes 00: transmitter 01: transmitter (AIDA) 02: transmitter with test input 10: basic receiver - automatic restart 11: basic receiver - automatic restart (AIDA) 20: standard receiver - EDM/RES selectable 30: extended receiver - blanking/muting
z	Device type T: transmitter R: receiver
a	Resolution 14: 14 mm 20: 20 mm 30: 30 mm 40: 40 mm 90: 90 mm
hhhh	Protective field height 150 ... 3000: from 150 mm to 3000 mm
e	Host/Guest (optional) H: Host MG: Middle Guest G: Guest
i	Interface (optional) /A: AS-i
ooo	Option /V: high Vibration-proof EX2: explosion protection (zones 2 + 22) SPG: Smart Process Gating

Note



A list with all available device types can be found on the Leuze website at www.leuze.com.

Notes



Observe intended use!



- ↪ The product may only be put into operation by competent persons.
- ↪ Only use the product in accordance with its intended use.

Accessories

Connection technology - Interconnection cables

	Part no.	Designation	Article	Description
	429278	CB-M12-2000E-8TP	Interconnection cable	Connection 1: Connector, M12, Axial, Female, A-coded, 8 -pin Connection 2: Connector, M12, Axial, Male, A-coded, 8 -pin Shielded: Yes Cable length: 2,000 mm Sheathing material: PUR

Mounting technology - Mounting brackets

	Part no.	Designation	Article	Description
	429006	BT-2L-HG	Mounting device set	Mounting bracket, at device: Screw type Material: Metal

Mounting technology - Swivel mounts

	Part no.	Designation	Article	Description
	429395	BT-2HF-G	Mounting bracket set	Fastening, at system: Through-hole mounting Mounting bracket, at device: Clampable Type of mounting device: Turning, 360° Material: Metal, Plastic

Services

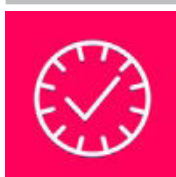
	Part no.	Designation	Article	Description
	S981050	CS40-I-140	Safety inspection	Details: Checking of a safety light barrier application in accordance with current standards and guidelines. Inclusion of the device and machine data in a database, production of a test log per application. Conditions: It must be possible to stop the machine, support provided by customer's employees and access to the machine for Leuze employees must be ensured.

Accessories

	Part no.	Designation	Article	Description
	S981046	CS40-S-140	Start-up support	Details: For safety devices including stopping time measurement and initial inspection. Conditions: Devices and connection cables are already mounted, price not including travel costs and, if applicable, accommodation expenses.

Note	
	A list with all available accessories can be found on the Leuze website in the Download tab of the article detailed page.