

Technical data sheet

Safety laser scanner

Part no.: 53800200

RSL311-S/CU308-M12



For illustration purposes only

Contents

- Technical data
- Dimensioned drawings
- Electrical connection
- Circuit diagrams
- Operation and display
- Notes
- Accessories



Technical data

Basic data

Series	RSL 300
Application	Stationary access guarding Stationary danger zone guarding

Functions

Functions	Dynamic contactor monitoring (EDM), selectable Four-field mode Start/restart interlock (RES), selectable
-----------	--

Characteristic parameters

Type	3, IEC/EN 61496
SIL	2, IEC 61508
SILCL	2, IEC/EN 62061
Performance Level (PL)	d, EN ISO 13849-1
PFH _D	9E-08 per hour
Mission time T _M	20 years, EN ISO 13849-1
Category	3, EN ISO 13849

Protective field data

Resolution (adjustable)	50/70 mm
Minimum adjustable range	50 mm
Number of field pairs, switchable	1
Number of quads, switchable	1
Number of protective functions	1 Piece(s)
Number of independent sensor configurations	1
Diffuse reflection, min.	1.8 %
Operating range	0 ... 3 m

Warning field data

Number of field pairs	1
Operating range	0 ... 15 m
Object size	150 mm x 150 mm
Diffuse reflection, min.	10 %

Optical data

Light source	Laser, Infrared
Wavelength	905 nm
Laser class	1, IEC/EN 60825-1:2014
Transmitted-signal shape	Pulsed
Repetition frequency	90 kHz
Angular resolution	0.2 °
Scanning angle	270 °

Electrical data

Protective circuit	Overvoltage protection
Performance data	
Supply voltage U _B	24 V, DC, -30 ... 20 %
Current consumption (without load), max.	700 mA, (use power supply unit with 3 A)
Power consumption, max.	17 W, For 24 V, plus output load
Outputs	
Number of signal outputs, configurable	3 Piece(s)
Number of safety-related switching outputs (OSSDs)	2 Piece(s)

Safety-related switching outputs

Type	Safety-related switching output OSSD
Switching voltage high, min.	20.8 V
Switching voltage low, max.	2 V
Voltage type	DC
Switching current, max.	300 mA

Safety-related switching output 1

Assignment	Connection 1, pin 5
Switching element	Transistor, PNP

Safety-related switching output 2

Assignment	Connection 1, pin 6
Switching element	Transistor, PNP

Time behavior

Response time	80 ms, ≥
---------------	----------

Service interface

Type	Ethernet
Ethernet	
Function	Configuration/parametization TCP/IP
Connection	M12 connector, 4-pin, D-coded

Connection

Number of connections	2 Piece(s)
Connection 1	
Function	Machine interface
Type of connection	Connector
Thread size	M12
Type	Male
Material	Metal
No. of pins	8 -pin
Encoding	A-coded

Connection 2

Function	Data interface
Type of connection	Connector
Thread size	M12
Type	Female
Material	Metal
No. of pins	4 -pin
Encoding	D-coded

Cable properties

Cable resistance, max.	15 Ω
------------------------	------

Mechanical data

Dimension (W x H x L)	140.2 mm x 148.6 mm x 140.3 mm
Housing material	Metal Plastic
Metal housing	Diecast zinc
Lens cover material	Plastic/PC
Net weight	3,000 g
Housing color	Yellow, RAL 1021
Type of fastening	Mounting plate Through-hole mounting Via optional mounting device

Technical data

Operation and display

Type of display	Alphanumerical display
	LED indicator
Number of LEDs	3 Piece(s)
Type of configuration	Software Sensor Studio
Operational controls	Software Sensor Studio

Environmental data

Ambient temperature, operation	0 ... 50 °C
Ambient temperature, storage	-20 ... 60 °C
Relative humidity (non-condensing)	15 ... 95 %

Certifications

Degree of protection	IP 65
Protection class	III, EN 61140
Approvals	c UL US
	TÜV Süd
Test procedure for EMC in accordance with standard	DIN 40839-1/3
	EN 61496-1
Test procedure for oscillation in accordance with standard	EN 60068-2-6
Test procedure for continuous shock in accordance with standard	IEC 60068-2-29
US patents	US 10,304,307B
	US 7,656,917 B
	US 7,696,468 B
	US 8,520,221 B

Classification

Customs tariff number	85365019
ECLASS 5.1.4	27272705
ECLASS 8.0	27272705
ECLASS 9.0	27272705
ECLASS 10.0	27272705
ECLASS 11.0	27272705
ECLASS 12.0	27272705
ECLASS 13.0	27272705
ECLASS 14.0	27272705
ECLASS 15.0	27272705
ETIM 5.0	EC002550
ETIM 6.0	EC002550
ETIM 7.0	EC002550
ETIM 8.0	EC002550
ETIM 9.0	EC002550
ETIM 10.0	EC002550

Dimensioned drawings

All dimensions in millimeters

Dimensions safety laser scanner with connection unit

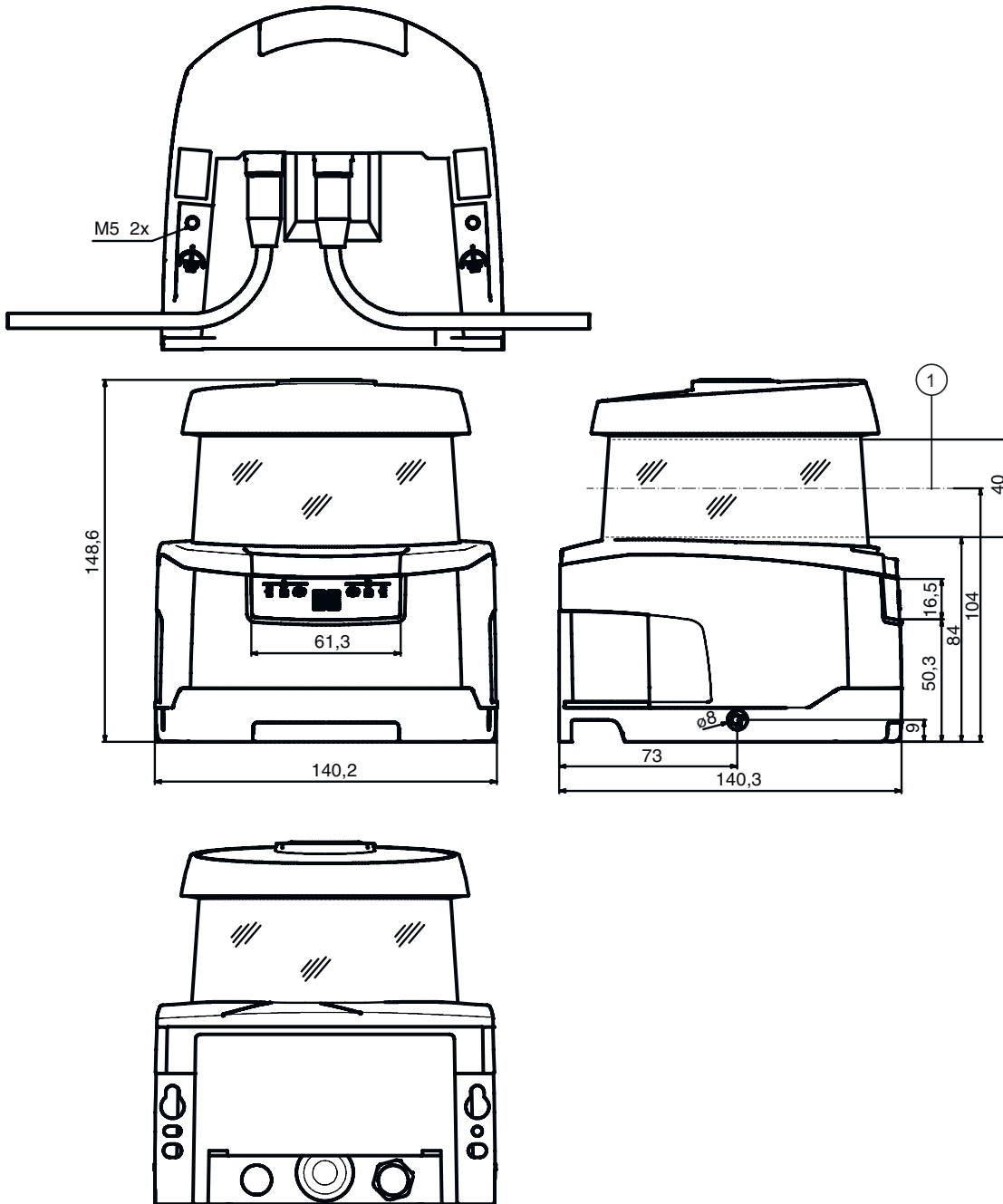

1 Scan level

Dimensioned drawings

Mounting dimensions safety laser scanner with connection unit



Minimum space requirements for installation and replacement of scanner unit

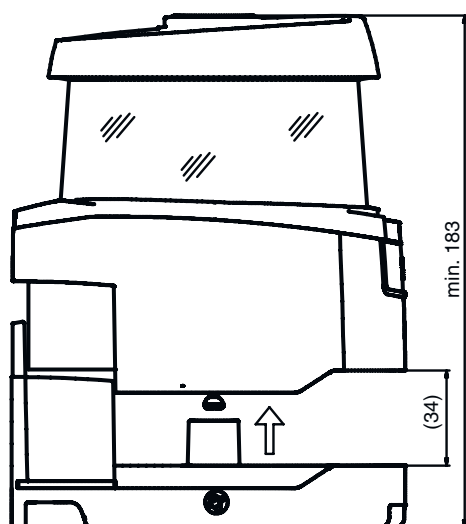

Dimensioned drawings

Dimensions of scanning range



1 Reference point for distance measurement and protective field radius

Electrical connection

Connection 1

Function	Machine interface
Type of connection	Connector
Thread size	M12
Type	Male
Material	Metal
No. of pins	8 -pin
Encoding	A-coded
Connector housing	FE/SHIELD

Pin	Pin assignment	Conductor color
1	RES1	White
2	U _B	Brown
3	EA1	Green
4	A1	Yellow
5	OSSDA1	Gray
6	OSSDA2	Pink
7	GND / Ground	Blue
8	MELD	Red

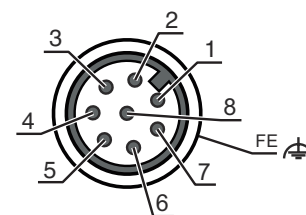

Connection 2

Function	Data interface
Type of connection	Connector
Thread size	M12
Type	Female
Material	Metal
No. of pins	4 -pin
Encoding	D-coded
Connector housing	FE/SHIELD

Electrical connection

Pin	Pin assignment	Conductor color
1	TD+	Yellow
2	RD+	White
3	TD-	Orange
4	RD-	Blue

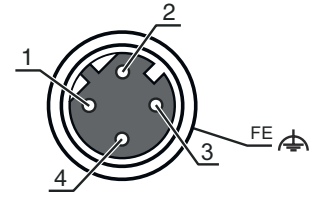

Circuit diagrams

RSL 410 with MSI-SR4B safety relay

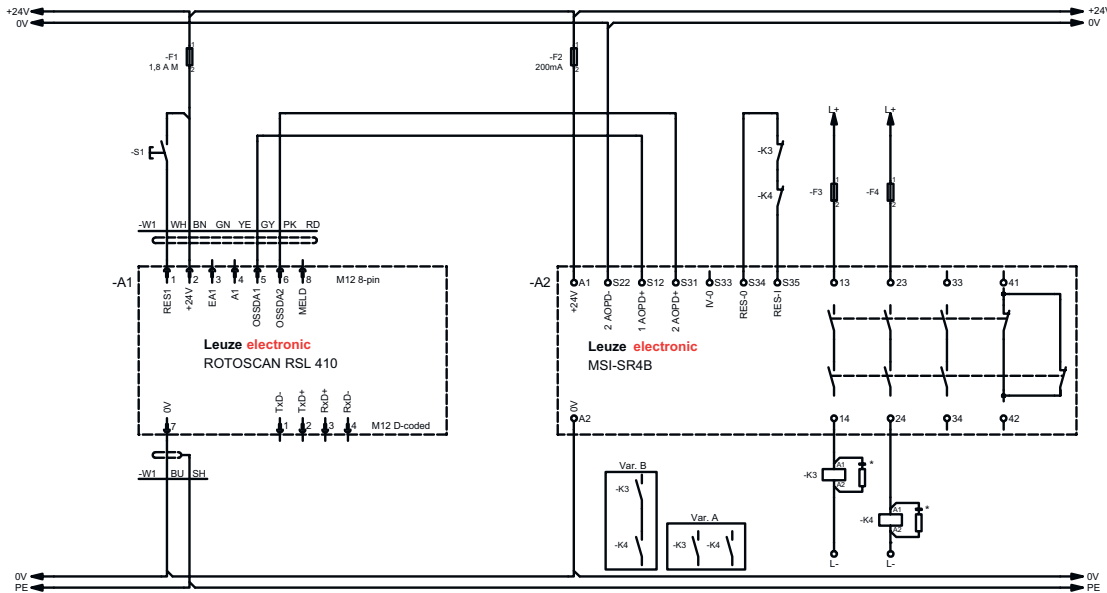

* Spark extinction circuit, suitable spark extinction provided

Operation and display

LED	Display	Meaning
1	Off	Device switched off
	Red, continuous light	OSSD off
	Red, flashing	Error
2	Green, continuous light	OSSD on
	Off	RES deactivated or RES activated and released
	Yellow, flashing	Protective field occupied
3	Yellow, continuous light	RES activated and blocked but ready to be unlocked - protective field free and linked sensor is enabled if applicable
	Off	Free warning field
4	Blue, continuous light	Warning field interrupted
	Off	Four field mode: warning field 3 free
5	Blue, continuous light	Four field mode: warning field 3 interrupted
	Yellow, flashing	Four field mode: warning field 2 interrupted

Notes

⚠ Observe intended use!

The product may only be put into operation by competent persons.
 Only use the product in accordance with its intended use.

⚠ ATTENTION! INVISIBLE LASER RADIATION – CLASS 1 LASER PRODUCT

The device satisfies the requirements of IEC/EN 60825-1:2014 safety regulations for a product of **laser class 1** and complies with 21 CFR 1040.10 except for conformance with IEC 60825-1 Ed. 3., as described in Laser Notice No. 56, dated May 8, 2019.

Observe the applicable statutory and local laser protection regulations.

The device must not be tampered with and must not be changed in any way.
 There are no user-serviceable parts inside the device.
 Repairs must only be performed by Leuze electronic GmbH + Co. KG.

Accessories

Connection technology - Connection cables



	Part no.	Designation	Article	Description
	50135128	KD S-M12-8A-P1-050	Connection cable	Connection 1: Connector, M12, Axial, Female, A-coded, 8 -pin Connector, LED: No Connection 2: Open end Shielded: Yes Cable length: 5.000 mm Sheathing material: PUR

Connection technology - Interconnection cables

	Part no.	Designation	Article	Description
	50135081	KSS ET-M12-4A-RJ45-A-P7-050	Interconnection cable	Suitable for interface: Ethernet Connection 1: Connector, M12, Axial, Male, D-coded, 4 -pin Connection 2: RJ45 Shielded: Yes Cable length: 5,000 mm Sheathing material: PUR
	50135082	KSS ET-M12-4A-RJ45-A-P7-100	Interconnection cable	Suitable for interface: Ethernet Connection 1: Connector, M12, Axial, Male, D-coded, 4 -pin Connection 2: RJ45 Shielded: Yes Cable length: 10,000 mm Sheathing material: PUR
	50135083	KSS ET-M12-4A-RJ45-A-P7-150	Interconnection cable	Suitable for interface: Ethernet Connection 1: Connector, M12, Axial, Male, D-coded, 4 -pin Connection 2: RJ45 Shielded: Yes Cable length: 15,000 mm Sheathing material: PUR

Accessories

Mounting technology - Mounting brackets

	Part no.	Designation	Article	Description
	53800134	BT840M	Mounting bracket	Application: Mounting on chamfered 90° corner Dimensions: 84.9 mm x 72 mm x 205.2 mm Color: Yellow, RAL 1021 Type of fastening, at system: Through-hole mounting Type of fastening, at device: Screw type Material: Metal
	53800132	BTF815M	Mounting bracket	Application: Mounting bracket for floor mounting Dimensions: 186 mm x 120 mm x 288 mm Scan level height: 150 mm Color: Yellow, RAL 1021 Type of fastening, at system: Through-hole mounting Type of fastening, at device: Screw type Material: Metal
	53800133	BTF830M	Mounting bracket	Application: Mounting bracket for floor mounting Dimensions: 186 mm x 275 mm x 288 mm Scan level height: 300 mm Color: Yellow, RAL 1021 Type of fastening, at system: Through-hole mounting Type of fastening, at device: Screw type Material: Metal

Mounting

	Part no.	Designation	Article	Description
	53800131	BTP800M	Loop guard	Dimensions: 160 mm x 169 mm Color: Black Material: Metal

General

	Part no.	Designation	Article	Description
	430400	RS4-clean-Set1	Cleaning set	Number of cleaning cloths: 40 Piece(s) Content of cleaning fluid: 150 ml

Services

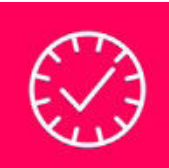
	Part no.	Designation	Article	Description
	S981051	CS40-I-141	Safety inspection	Details: Checking of a safety laser scanner application in accordance with current standards and guidelines. Inclusion of the device and machine data in a database, production of a test log per application. Conditions: It must be possible to stop the machine, support provided by customer's employees and access to the machine for Leuze employees must be ensured.

Accessories

	Part no.	Designation	Article	Description
	S981047	CS40-S-141	Start-up support	<p>Details: For safety devices including stopping time measurement and initial inspection.</p> <p>Conditions: Devices and connection cables are already mounted, price not including travel costs and, if applicable, accommodation expenses.</p>

Note	
	<p>A list with all available accessories can be found on the Leuze website in the Download tab of the article detailed page.</p>