

Original operating instructions

## MSI-mx/Rx

## MSI-mxE/Rx

### Modular safety interface



© 2021

Leuze electronic GmbH & Co. KG

In der Braike 1

D-73277 Owen / Germany

Phone: +49 7021 573-0

Fax: +49 7021 573-199

<http://www.leuze.com>

[info@leuze.com](mailto:info@leuze.com)

<b>1</b>	<b>About this document</b> .....	<b>5</b>
<b>2</b>	<b>System overview and range of applications</b> .....	<b>5</b>
2.1	General information .....	5
2.2	Certifications .....	5
2.3	Terminology .....	5
2.4	Nomenclature MSI-mx(E)/Rx .....	6
<b>3</b>	<b>Safety</b> .....	<b>8</b>
3.1	Intended use and foreseeable misuse .....	8
3.1.1	Intended use .....	8
3.1.2	Foreseeable misuse .....	10
3.2	Competent personnel .....	10
3.3	Responsibility for safety .....	10
3.4	Exemption of liability .....	10
3.5	Connection of E-STOP buttons .....	11
3.6	Additional safety notices for the special function "Muting" .....	11
<b>4</b>	<b>System design and functions</b> .....	<b>12</b>
4.1	System design .....	12
4.2	DIP switch settings .....	12
4.2.1	MSI-mx module DIP switch .....	12
4.2.2	I/O-mx module DIP switch .....	12
4.2.3	Rx output DIP switch .....	13
4.3	Operating modes and functions .....	14
4.3.1	Operating modes – interlocking and contactor monitoring functions .....	14
4.3.1.1	Operating mode: with start/restart interlock – with dynamic contactor monitoring .....	15
4.3.1.2	Operating mode: with start/restart interlock – with static contactor monitoring .....	15
4.3.1.3	Operating mode: with start/restart interlock – without contactor monitoring .....	15
4.3.1.4	Operating mode: without start/restart interlock – without contactor monitoring .....	16
4.3.1.5	Operating mode: with start/without restart interlock – without contactor monitoring .....	16
4.3.2	Muting function .....	16
4.3.2.1	Sequential muting, connections at M1 to M4 .....	17
4.3.2.2	Parallel muting (2.5 s), connections M2 and M3 .....	17
4.3.2.3	Parallel double muting (dual-range muting) using connections M2 and M3, M1 and M4 .....	17
4.3.2.4	Testable and non-testable muting sensors .....	17
4.3.2.5	Muting display function .....	18
4.3.2.6	Muting restart while transport material is located in the muting area .....	18
4.3.2.7	Muting time limit - 10 minutes .....	19
4.3.2.8	Example: Sequential muting, non-testable muting sensors .....	19
4.3.2.9	Example: Sequential muting, testable muting sensors .....	20
4.3.2.10	Example: Parallel muting, non-testable muting sensors .....	21
4.3.2.11	Example: Parallel muting, testable muting sensors .....	22
4.3.2.12	Example: Parallel double muting, non-testable muting sensors .....	23
4.3.3	Safety door monitoring .....	23
4.3.4	Relay switching cycle monitoring function with prefailure message (in /Rx versions) ..	24
4.4	Indicators .....	24
4.5	Signal outputs .....	25
4.6	Diagnostics function .....	26

**5 Electrical connection . . . . . 28**

5.1 Installation instructions . . . . . 28

5.2 Power supply requirements . . . . . 28

5.3 Connecting AOPDs, type 4 or type 2. . . . . 28

5.4 Connecting to the machine control . . . . . 30

**6 Connection examples. . . . . 31**

**7 Technical data and order guide . . . . . 33**

7.1 MSI-mx(E) . . . . . 33

7.2 /Rx output . . . . . 35



7.3 Dimensioned drawing . . . . . 36

7.4 Order guide . . . . . 36

**8 EC Declaration of Conformity. . . . . 37**

## 1 About this document

These connecting and operating instructions contain information on the approved purpose and use of MSI safety interfaces.

 <b>ATTENTION!</b>	
	All information provided in the connecting and operating instructions, especially the Safety Notices, must be observed.

Safety and warning notices are marked with the  symbol.

These connecting and operating instructions must be kept in a safe place. It must be available during the mission time of the MSI safety interfaces.

**Leuze electronic GmbH + Co. KG is not liable for damages caused by improper use. Knowledge of these connecting and operating instructions is considered an element of proper use.**

## 2 System overview and range of applications

### 2.1 General information

The Modular Safety Interface (MSI) serves as a link between one or more active optoelectronic protective devices (AOPD), type 2, type 3 or type 4, and the machine control. All MSI safety components include start/restart interlock and contactor monitoring functions that can be activated and deactivated. They are also equipped with a series of signal outputs and LED indicators as well as a diagnostic interface to a PC.

In addition, MSI-mx(E)/Rx offers a muting function to suppress the protective function of an AOPD, e.g. when transporting materials through the protective field. Special safety regulations for muting are described in Chapter 3.6 below.

Leuze electronic offers a range of additional MSI safety interfaces with standard and special function, e.g. muting (intentional suppression of the safety function) or cycle control (single cycle, two cycle).

All MSI safety modules are equipped with relay outputs. The x-variants allow the additional connection of safety switches or E-STOP buttons acc. to category 4.

All information also applies to UL compliant version MSI-mxE/Rx, provided that nothing to the contrary is stated.

### 2.2 Certifications

<b>Europe</b>
EC Type Examination TÜV SÜD

### 2.3 Terminology

1.1-2.2	State Output Safety Switches
AOPD	Active Optoelectronic Protective Device
Diagn.	Diagnosis Function
EDM	External Device Monitoring Contactor monitoring
ESPE	Electro-sensitive Protective Equipment
Fault	Relay error
I/O-mx module	Extended input/output module
Lamp Warn.	Muting Indicator Failure Warning

Locked	Start/Restart Interlock active
MSI Fault	MSI error
Muting Fault/Failure	Muting error
M1 - M4	Muting Input 1 - 4
Muting Indicators	Muting indicators
Muting Sensors	Muting sensors
N.C.	Normally Closed Contact
N.O.	Normally Open Contact
OSSD	Safety-related switching output
Reset	Start/Restart Interlock Initiator
RS 232	Interface RS 232
S1 - S4	Safety input 1 - 4 Safety input 1-4
S1 & S2 S3 & S4	Indication protective fields free/interrupted
Safety Switches	Safety Switches
SSD	Secondary Switching Device Switches to ON state when the MSI is ready for operation
State	Status
Test	Test Signal Outputs
T1, T2	Test signal output 1, 2
Warn. (I/O-mx module)	Warning muting indicator defective
Warn. (Rx module)	Warning (preset number of switching operations exceeded)

## 2.4 Nomenclature MSI-mx(E)/Rx

MSI	Modular Safety Interface
m	With muting function
x	<p>Extended functions</p> <p>The extended version offers the following standard functions for either 2 AOPD, type 4, or up to 4 AOPDs, type 2:</p> <ul style="list-style-type: none"> <li>• Start/restart interlock</li> <li>• Contactor monitoring</li> <li>• Diagnostics function</li> </ul> <p>and the following special functions for 1 AOPD type 4 or 1 AOPD type 2:</p> <ul style="list-style-type: none"> <li>• Sequential muting</li> <li>• Parallel muting (2.5 s)</li> </ul> <p>or for 2 AOPDs of type 4 or type 2</p> <ul style="list-style-type: none"> <li>• Parallel double muting</li> <li>• Additional connection of safety switches (e.g. safety gate switches) possible</li> <li>• Displays and signal outputs for protective and muting operation</li> </ul>

/Rx	Relay output with extended functions: <ul style="list-style-type: none"><li>• Two safety-related normally open contacts, OSSD 1 and OSSD 2</li><li>• One safety-related normally closed contact OSSD 3</li><li>• One normally open contact "MSI readiness" SSD</li><li>• Status indicators and signal outputs</li></ul> Additional special function: <ul style="list-style-type: none"><li>• Relay switching cycle monitoring with prefailure message</li></ul>
(E)	Additional empty housing for convection

### 3 Safety

Before using the safety interface, a risk assessment must be performed according to valid standards (e.g. EN ISO 12100, EN ISO 13849-1, EN 62061). The result of the risk assessment determines the required safety level of the safety interface (see table in chapter 3.1.1). For mounting, operating and testing, document "MSI-mx(E)/Rx Modular Safety Interface" as well as all applicable national and international standards, regulations, rules and directives must be observed. Relevant and supplied documents must be observed, printed and handed to the affected personnel.



Before working with the safety interface, completely read and understand the documents applicable to your task.

In particular, the current version of the following national and international legal regulations apply for commissioning, technical tests and handling of safety sensors:

- Machinery Directive
- Low Voltage Directive
- Electromagnetic compatibility
- Use of Work Equipment Directive
- OSHA
- Safety regulations
- Accident-prevention regulations and safety rules
- Ordinance on Industrial Safety and Health and employment protection act
- Product Safety Law (ProdSG)

NOTE	
	Local agencies can also provide safety-relevant information (e.g. occupational safety and health inspectorate, employer's liability insurance association, labor inspectorate, OSHA).

#### 3.1 Intended use and foreseeable misuse

 <b>ATTENTION!</b>	
	<p>A running machine can cause severe injuries!</p> <p>↳ Make certain that, during all conversions, maintenance work and inspections, the system is securely shut down and protected against being restarted.</p>

##### 3.1.1 Intended use

- The safety interface may only be used after it has been selected in accordance with the respectively applicable instructions and relevant standards, rules and regulations regarding labor protection and safety at work, and after it has been installed on the machine, connected, commissioned, and checked by a competent person.
- When selecting the safety interface it must be ensured that its safety-related capability meets or exceeds the required Performance Level PL<sub>r</sub> ascertained in the risk assessment.

The following table shows the safety-related characteristic parameters of the MSI-mx(E)/Rx modular safety interfaces.



Type in accordance with EN 61496-1	Type 4
SIL in accordance with EN 61508	SIL 3
Performance Level (PL) in accordance with EN ISO 13849-1:2015	PL e
Category in accordance with EN ISO 13849-1:2015	Cat. 4
Mean probability of a dangerous failure per hour (PFH <sub>d</sub> ) as a function of the mean number of annual switching cycles of the relay n <sub>op</sub> *	100% Load n <sub>op</sub> = 4,800: 1.6 x 10 <sup>-08</sup> 1/h 60% Load n <sub>op</sub> = 4,800: 1.3 x 10 <sup>-08</sup> 1/h 100% Load n <sub>op</sub> = 28,800: 3.8 x 10 <sup>-08</sup> 1/h 60% Load n <sub>op</sub> = 28,800: 1.6 x 10 <sup>-08</sup> 1/h 100% Load n <sub>op</sub> = 86,400: 9.5 x 10 <sup>-08</sup> 1/h 60% Load n <sub>op</sub> = 86,400: 2.4 x 10 <sup>-08</sup> 1/h
*n <sub>op</sub> = mean number of annual actuations, see C.4.2 and C.4.3 of EN ISO 13849-1:2015  Use the following formula to calculate the mean number of annual actuations:  $n_{op} = (d_{op} \cdot h_{op} \cdot 3600 \text{ s/h}) \div t_{Zyklus}$  In doing so, make the following assumptions with regard to the use of the component: h <sub>op</sub> = mean operating time in hours per day d <sub>op</sub> = mean operating time in days per year t <sub>cycle</sub> = mean operating time between the start of two successive cycles of the component (e.g switching of a valve) in seconds per cycle	

- The safety interface is used in combination with one or more multiple light beam safety devices or safety light curtains to safeguard points of operation or danger zones.
- The control of the machine or system that is to be safeguarded must be electrically influenceable. A switch-off command initiated by an MSI must result in an immediate shutdown of the dangerous movement.
- The "Reset" acknowledgment button for unlocking the start/restart interlock must be mounted in such a way that the entire danger zone can be seen from its mounting location.
- Signal outputs (state output) and SSDs (Secondary Switching Device) must not be used for switching safety-relevant signals.
- The safety interface is designed for installation in a cabinet or a protective housing with a degree of protection of at least IP 54.
- The 24 V DC ±20% power supply must guarantee safe insulation from the mains voltage and be able to bridge a power outage period of 20 ms.
- Depending on external wiring, dangerous voltages may be present at the switching outputs. In addition to the power supply, these must be switched off and safeguarded against being switched back on prior to all work on the MSI-mx(E)/Rx.
- These operating instructions must be included with the documentation of the machine on which the protective device is installed so that they are available to the operator at all times.
- In the event of changes to the MSI-mx(E)/Rx, all warranty claims against the manufacturer of the safety interface are rendered void.
- The safety distance between the AOPD and the point of operation is to be maintained. It is calculated according to the formulas for machine-specific C standards or given in the general B1 standard EN ISO 13855. Both the reaction time of the test monitoring unit and the braking time of the machine must be taken into account.
- Two switching contacts must always be looped into the switch-off circuit of the machine. To prevent welding, relay switching contacts must be fused/protected externally according to the technical data.
- The safety interface must be exchanged after a maximum of 20 years. Repairs or the exchange of wear parts do not extend the mission time.
- The safety interface satisfies the requirements of safety category 4 acc. to EN ISO 13849-1:2015. If,

however, an AOPD of a lower safety category is connected, the total category for the given path of the control cannot be higher than that of the connected AOPD.



- Cross-circuits between S1 and S2 or S3 and S4 are only detected by the MSI safety module if both time-delayed test signal outputs, T1 and T2, are used for the connected protective device(s) with relay output. AODPs of type 4 with safety-relevant transistor outputs and their own cross circuit monitoring can be directly connected to S1 and S2 or S3 and S4.

### 3.1.2 Foreseeable misuse

Any use other than that defined under the "approved purpose" or which goes beyond that use is considered improper use!

e.g.,

- Applications in explosive or easily flammable atmospheres

 <b>ATTENTION!</b>	
	Such instances can jeopardize the health and lives of the personnel operating the machinery and/or may cause damage to property.

### 3.2 Competent personnel

Prerequisites for competent personnel:

- They have a suitable technical education.
- They know the rules and regulations for labor protection, safety at work and safety technology and can assess the safety of the machine.
- They know the instructions for the safety interface and the machine.
- They were instructed by the responsible individuals on the mounting and operation of the machine and of the safety interface.

### 3.3 Responsibility for safety

Manufacturer and operator must ensure that the machine and implemented safety interface function properly and that all affected persons are adequately informed and trained.

The type and content of all imparted information must not lead to unsafe actions by users.

The manufacturer of the machine is responsible for:

- Safe machine construction
- Safe implementation of the safety interface
- Imparting all relevant information to the operating company
- Adhering to all regulations and directives for the safe commissioning of the machine

The operator of the machine is responsible for:

- Instructing the operating personnel
- Maintaining the safe operation of the machine
- Adhering to all regulations and directives for labor protection and safety at work
- Regular testing by competent personnel (see chapters 3 and 3.2)

### 3.4 Exemption of liability

Leuze electronic GmbH + Co. KG is not liable in the following cases:

- Safety interface is not used as intended.
- Safety notices are not adhered to.
- Reasonably foreseeable misuse is not taken into account.
- Mounting and electrical connection are not properly performed.
- Proper function is not tested.
- Changes (e.g., constructional) are made to the safety interface.

### 3.5 Connection of E-STOP buttons

- It must be ensured that the EMERGENCY STOP function is always and immediately effective. **E-STOP buttons must not be connected at sensor inputs which provide for muting or cycle control functions!** In chapter 6 "Connection examples", there is a particular example illustrating the connection of a two-channel E-STOP button.
- E-STOP buttons connected to the MSI act only on the safety circuit to which the AOPD is assigned. Thus, it can be considered to be an area E-STOP. The limited sphere of action of the button is to be clearly marked for the operating personnel.

### 3.6 Additional safety notices for the special function "Muting"

- Muting is the intentional suppression of the safety function of an AOPD. It is used, for instance, to allow the material flow to pass through the protective field without triggering a switch-off signal. E-Stop command devices must not be muted.
- During the muting function the protective function of this AOPD is no longer active! For this reason other measures must be taken to ensure that it is not possible to reach or go into the point of operation. For instance, if the material transport completely fills the access area, or if there is no danger while muting is active, such as during the return motion of a tool.
- The muting sensors must be positioned in such a way that it is impossible to manipulate them easily. For example, optical sensors can be mounted so high or so far apart that the operating personnel cannot cover them either simultaneously or at all. If switches are used, we recommend a concealed installation.
- The operating personnel must be expressly informed that the protective device offers no protection in the muting state. Any manipulations of or unauthorized entries into the system present immediate danger to personnel.
- An additional sign should be put up stating that the safety light grid offers no protection when the Muting indicator is lit and it is dangerous to reach or walk through the protective field. Muting indicators and sign should be placed in a clearly visible location near the muting area.
- The start button must be positioned so that it cannot be actuated by persons who are located in the protective field.

## 4 System design and functions

### 4.1 System design

Two microprocessors handle the redundant processing of the signal sequences within the intelligent modular safety interface MSI. The results of the two processors are continuously compared. If any deviations are found, the safety-related outputs are immediately switched off and the LED indicating an MSI failure lights up.

Sensor signals at inputs S1 and S2 as well as S3 and S4 are checked. Depending on which of the functions (as described below) are selected, when the protective fields of all connected AOPDs are free, the MSI outputs switch automatically to the ON state (without start/restart interlock) or remain in the OFF state until the reset button has been pressed and released (with start/restart interlock = standard operating mode).

On the output side, the MSI-mx(E)/Rx is equipped with two positive-guided normally open contacts and one positive-guided normally closed contact and offers an additional normally open contact SSD (Secondary Switching Device) which assumes the ON state when the MSI-mx(E)/Rx is ready for operation.

⚠ ATTENTION!	
	The SSD contact does not open when a protective field is interrupted! It may be used to switch off a second circuit in the event of a fault of the MSI.

The MSI safety interface comes in a 52.5/70 mm-wide slide-in housing that holds the MSI-mx module, the I/O-mx module and the output module. It is suitable for mounting on a grounded 35 mm standard rail.

### 4.2 DIP switch settings

#### 4.2.1 MSI-mx module DIP switch

To reset the DIP switches: cut off the voltage supply to the interface (see chapter "Safety Notices"), loosen the mounting tabs of the component with the imprint "MSI-mx" and pull this module partly out of the housing:



Functions **only** in conjunction with external wiring, see Chapter 4.3:

DIP switch	DS4	DS3	DS2	DS1
Function	With-out	Lock	Contactor monitoring	Without
Up		Start interlock only	Static• - none••	–
Down		Start/restart interlock* - none**	Dynamic	–

Factory setting: all switches down

- \* See chapter 4.3.1.1 – 4.3.1.3
- \*\* See chapter 4.3.1.4
- See chapter 4.3.1.2
- See chapter 4.3.1.3 – 4.3.1.5

#### 4.2.2 I/O-mx module DIP switch

To reset the DIP switches: cut off the voltage supply to the interface (see chapter "Safety Notices"), loosen the mounting tabs of the component and pull the I/O-mx module (to the right of the MSI-mx module) partly out of the housing:



DIP switch	MU5	MU4	MU3	MU2	MU1
Function	Muting area 2	Muting area 1	Muting sensors	Muting time limit	Parallel muting
Up	S3 only	S1 only	Non-testable	Without	Muting area 1+2
Down	S3 & S4	S1 & S2	Testable	10 min	Muting area 1

Factory setting: all switches down

### 4.2.3 Rx output DIP switch

To reset the DIP switches: cut off the voltage supply to the interface (see chapter "Safety Notices"), loosen the mounting tabs of the component with the imprint "Rx" and pull this module partly out of the housing.

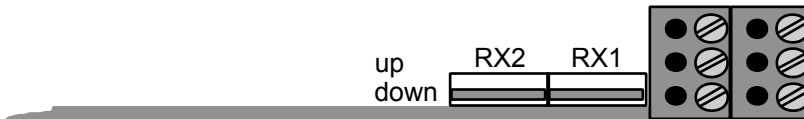

DIP switch	RX2	RX1
Function	Warning: 1,000,000 switching cycles performed	
Up		
Down	x	x

DIP switch	RX2	RX1
Function	Warning: 500,000 switching cycles performed	
Up	x	
Down		x

DIP switch	RX2	RX1
Function	Warning: 200,000 switching cycles performed	
Up		x
Down	x	

DIP switch	RX2	RX1
Function	Warning: 100,000 switching cycles performed	
Up	x	x
Down		

Factory setting: All switches down (warning after 1,000,000 switching cycles)

Recommended setting: See chapter 4.3.4

### 4.3 Operating modes and functions

MSI-mx(E)/Rx permits the following operating modes and functions:

- Protective function with the possibility of the following combinations of interlocking function and contactor monitoring function.
- Five operating modes can be selected by means of external wiring and the DIP switches DS2 and DS3 on the MSI-mx module.
- Muting function by way of testable or non-testable muting sensors in sequential or parallel muting mode. Parallel double muting with two muting sensors for each muting area is possible. Further details are given in chapter 4.3.2.
- Safety door monitoring can be integrated into the safety function of the MSI-mx(E)/Rx. Four additional inputs are available for this purpose. See also chapter 4.3.3.

#### 4.3.1 Operating modes – interlocking and contactor monitoring functions

The following 5 combinations can be selected by externally wiring the MSI safety interface and/or by changing the settings of the DIP switches DS2 and DS3 in the MSI module:

OPERATING MODES			
Chapter	Type of locking	Type of contactor monitoring	Muting function
4.3.1.1	With start/restart interlock	With dynamic contactor monitoring	Possible
4.3.1.2	With start/restart interlock	With static contactor monitoring	Possible
4.3.1.3	With start/restart interlock	Without contactor monitoring	Possible
4.3.1.4	Without start/restart interlock	Without contactor monitoring	Not permitted
4.3.1.5	With start/without restart interlock	Without contactor monitoring	Not permitted

<b>⚠ ATTENTION!</b>	
	The MSI safety interface is factory-set for the operating mode "with start/restart interlock and dynamic contactor monitoring function". If this setting is changed, these functions (i.e. the appropriate safety level) must be guaranteed by other means.

- Types of interlocking functions  
The "start interlock function" ensures that when the system is switched on or when the supply voltage returns, even if the protective field is free, the safety-related output contacts (OSSDs) do not automatically go into ON state, but only after the reset button has been pressed and released. The "start/restart interlock function" prevents the OSSDs from automatically entering the ON state when the protective fields of one or more of the connected AOPDs are released again after an interruption. Here as well, the reset button must be pressed and released to initiate the system. Cyclic operation and muting are not permissible if there is no locking (and hence no reset button) since the start button is also used to perform the function of the cyclic and muting reset.
- Types of contactor monitoring  
The function "dynamic contactor monitoring" monitors the contactors and relays connected downstream from the MSI safety interface. Each time before the OSSDs switch to the ON state, a check is made of whether the subsequent circuit elements have closed and reopened. If they have not, the OSSDs of the MSI safety interface remain in the OFF state. If the function "static contactor monitoring" is selected, a check is made of whether the subsequent switching elements are in an open state. If they are, the start/restart interlock can be unlocked.

**4.3.1.1 Operating mode: with start/restart interlock – with dynamic contactor monitoring**

External wiring requirements:

- Terminal 13 "Reset" Connected to 24 V DC supply via a start button
- Terminal 14 "EDM" Connected to 0 V via feedback contacts of the positive-guided downstream relay

Required DIP switch settings in the MSI module (chapter 4.2):

- DS3 down DS2 down (factory setting on delivery)

Start/restart interlock is no longer active when the protective fields of all connected AOPDs are free, the downstream relays have returned to their original state, and the reset button is pressed and released.

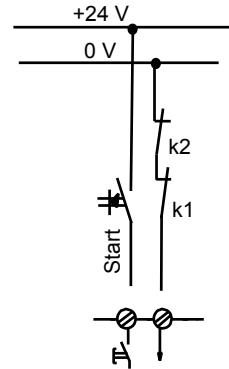

**4.3.1.2 Operating mode: with start/restart interlock – with static contactor monitoring**

External wiring requirements:

- Terminal 13 "Reset" Connected to 24 V DC supply via a start button
- Terminal 14 "EDM" Connected to 0 V via feedback contacts of the positive-guided downstream relay

Required DIP switch settings in the MSI module (chapter 4.2):

- DS3 down DS2 up

In this operating mode, if the protective fields are free, a check is made of whether the downstream switching elements have returned to their original state. If so, a release is issued by pressing and releasing the reset button.

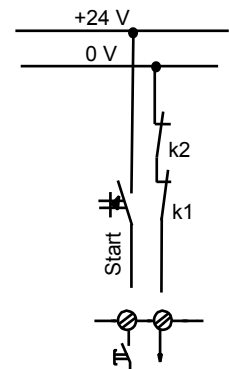

<b>⚠ ATTENTION!</b>	
	The dynamic monitoring of the downstream relays, which may be required in order to maintain the safety category, must be performed by other means.

**4.3.1.3 Operating mode: with start/restart interlock – without contactor monitoring**

External wiring requirements:

- Terminal 13 "Reset" Connected to 24 V DC supply via a start button
- Terminal 14 "EDM" Connected to 0 V

Required DIP switch settings in the MSI module (chapter 4.2):

- DS3 down DS2 up

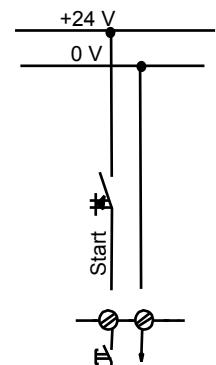

<b>⚠ ATTENTION!</b>	
	The monitoring of the downstream switching elements, which may be required in order to maintain the safety category, must be performed by other means.

**4.3.1.4 Operating mode: without start/restart interlock – without contactor monitoring**

Muting operation is not permissible in this operating mode!

External wiring requirements:

Terminal 13 "Reset" Connected to 0 V

Terminal 14 "EDM" Connected to 24 V DC

Required DIP switch settings in the MSI module (chapter 4.2):

DS3 down DS2 up

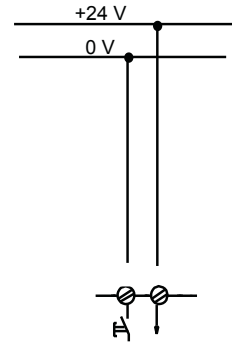

<b>⚠ ATTENTION!</b>	
	<p>After the supply voltage is applied, the OSSDs immediately go into the ON state if all of the protective fields of the connected AOPDs are free.</p> <p>The start/restart interlock function and the monitoring of the downstream switching elements, which may be required in order to maintain the safety category, must be performed by other means.</p>

**4.3.1.5 Operating mode: with start/without restart interlock – without contactor monitoring**

Muting operation is not permissible in this operating mode!

External wiring requirements:

Terminal 13 "Reset" Connected to 0 V

Terminal 14 "EDM" Connected to 24 V DC

Required DIP switch settings in the MSI module (chapter 4.2):

DS3 up DS2 up

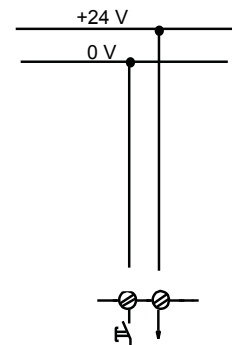

After the supply voltage is applied, the OSSDs remain in the OFF state even if all of the protective fields of the connected AOPDs are free.

<b>⚠ ATTENTION!</b>	
	<p>When the protective fields of all connected AOPDs are initially free, the OSSDs first enter the ON state when the protective field of the AOPD connected at S1 (for type 4: S1 and S2) is interrupted and released. Only then do the rest of the connected AOPDs respond to the interruption and release of their own protective fields by switching the OSSDs directly to the OFF and ON states.</p> <p>The restart interlock function and the monitoring of the downstream switching elements, which may be required in order to maintain the safety category, must be performed by other means.</p>

**4.3.2 Muting function**

Muting is the intentional suppression of the protective function. Special safety precautions must be observed if muting is being used. See special Safety Notices in chapter 3.6. The muting operation is initiated by the connected muting sensors. The MSI-mx automatically detects the muting mode based on which of the muting inputs (M1 to M4) are occupied. For instance, sequential muting will be performed when all inputs are occupied, and parallel muting takes place when M2 and M3 are occupied. Both of the muting indicators must be connected. See chapter 4.3.2.5.

Parallel double muting requires the occupation of the muting inputs M2 and M3 as well as for the second muting path M1 and M4. Additionally, it is necessary to change the position of the MU1 DIP switch in the I/O-mx module to up. See also chapter 4.2.2.



**Special feature for muting AOPDs of type 2**

When the DIP switch of the I/O-mx module is factory-set (MU4 down), the muting function applies for safety inputs S1 and S2. If a type 2 AOPD is to be muted, the muting area 1 must be set to "S1 only" (MU4 up) and the type 2 AOPD to be muted must be connected to S1. Similar to this, MU5 (up) can be used to set muting area 2 of S3 and S4 to "S3 only". Prerequisite for this is that MU1 (up) be used to select muting area 1 + 2 (parallel double muting). For DIP switch settings, see chapter 4.2.2.

**4.3.2.1 Sequential muting, connections at M1 to M4**

Sequential muting requires the connection of 4 muting sensors and their damping in a predetermined sequence. It is preferred when the material being transported (i.e. the transport vehicle) always has consistent dimensions and there is sufficient space available for the material intake. Examples are shown in chapter 4.3.2.8 and 4.3.2.9.

**4.3.2.2 Parallel muting (2.5 s), connections M2 and M3**

The muting process is initiated if the two inputs, M2 and M3, switch simultaneously (within 2.5 s of each other). Parallel muting is used when material of inconsistent size is being conveyed or when there is limited room in front of the muting station.

Parallel muting can be performed by two photoelectric sensors (separated transmitter and receiver or retro-reflective photoelectric sensors) whose beam paths intersect behind the protective field but within the danger zone. Examples of these and other possibilities can be found in chapter 4.3.2.10 and 4.3.2.11.

**4.3.2.3 Parallel double muting (dual-range muting) using connections M2 and M3, M1 and M4**

The MSI-mx(E)/Rx makes it possible to asynchronously suppress the safety function of the AOPDs located at both the system intake and the system output. This may be necessary, for instance, at a continuous production system.

This additional muting function requires that the DIP switch MU1 of the I/O-mx module is up. As always, M2 and M3 influence the parallel muting of area 1 (S1 and S2). They must switch within 2.5 seconds of each other in order to initiate the muting process.

For parallel muting, the muting sensors to be connected at M1 and M4 influence the muting of area 2 (S3 and S4). The same condition as above applies here: the two sensors must switch within 2.5 seconds of each other in order to initiate the muting process for area 2. See the example in chapter 4.3.2.12.



**Special feature for parallel double muting of AOPDs of type 2**

When the DIP switch MU1 of the I/O-mx module is up, the muting function takes effect both for muting area 1 (S1 and S2) and for muting area 2 (S3 and S4). If AOPDs of type 2 are to be muted, muting area 1 must be set to "S1 only" at MU4 (up) and muting area 2 must be set to "S3 only" at MU5 (up). The AOPDs of type 2 to be muted must be connected at S1 and S3. For settings, see chapter 4.2.2.

**4.3.2.4 Testable and non-testable muting sensors**

The following devices are suitable for use as muting sensors:

- Non-testable photoelectric sensors (transmitter/receiver or retro-reflective photoelectric sensors) with pnp output, dark-switching
- Testable and non-testable reflective diffuse sensors with pnp output, light-switching
- Mechanical position switches
- Inductive proximity switches
- Induction loops if metallic objects move into the path to be muted

 <b>ATTENTION!</b>	
	The cables to the individual muting sensors must be laid separately!

**Non-testable muting sensors**

Prerequisites: DIP switch MU3 in the I/O-mx module must be up

- pnp or switching output must provide 0 V in the non-dampened state
- pnp or switching output must provide 24 V DC in the dampened state

**Testable muting sensors**

Prerequisites: DIP switch MU3 in the I/O-mx module must be down (factory setting)

- Diffuse reflection sensors, light-switching, are suitable; with activation/test input and a reaction time of 2 to 18 ms.
- Test signal T1 must be used for the muting sensor at M2 (M4).
- Test signal T2 must be used for the muting sensor at M3 (M1).
- pnp output must provide 0 V in the non-dampened state and 24 V DC (plus above-mentioned test impulses) in the dampened state.

Example: SLS SR8.8/ER8/66-S12, polarized for light switching, from Leuze electronic

**4.3.2.5 Muting display function****Single muting for S1/S2, or in the case of type 2 for S1 only**

In case of muting, terminal 28 will deliver 24 V DC to muting indicator 1 connected to it to indicate the muting.

Terminal 29 serves as backup in case that muting indicator 1, which is connected to terminal 28, fails (broken filament or interrupted supply). Muting indicator 2 must be connected to terminal 29 to serve as back-up unit to take over the indicating function in case muting indicator 1 (connected to terminal 28) fails, in order to ensure fault-free operation.

With the automatic change from muting indicator 1 to muting indicator 2, the assigned LED "lamp warn" on the I/O-mx module flashes (1 impulse). If muting indicator 2 should fail (it is monitored constantly, even if it is not switched on), the LED "lamp warn" will also flash (2 impulses).

In addition to the indication, the impulses (1 or 2) are also directed to output terminal 30. This output will deliver an active-high signal during fault-free operation. Only if the second indicator fails as well, the MSI-mx(E)/Rx will enter a fault state and the OSSDs will switch to the OFF state.

**Special feature for double muting**

If double muting is selected via the DIP switch MU1, the output on terminal 28 takes over the muting indication of muting area 1, the output on terminal 29 takes over the muting indication of muting area 2. In this operating mode, the MSI-mx(E)/Rx goes into a fault state as soon as one of the indicators fails.

**4.3.2.6 Muting restart while transport material is located in the muting area**

If transport material is in the sensor area when switching on the system after a power interruption, after an E-Stop release or after termination of the muting function by incorrect sequence or time condition, a muting restart is always required.

If the transport material dampens at least one muting sensor but does not interrupt the protective field of the AOPD that is to be muted, press and release the start button to activate the transport system. Muting is not activated. As soon as the transport material interrupts the protective field, the OSSDs switch into the OFF-state and the muting indicators start to blink. Muting restart is now possible.

If the transport material dampens at least one muting sensor and, at the same time, the protective field of the AOPD that is to be muted when switching on is already interrupted, the OSSDs remain in the OFF state and the muting indicator flashes immediately. Muting restart is immediately possible.

Muting restart requires pressing the start button two times within 4 s. On the second activation of the start button the safety circuit is released immediately. On the second release of the start button the MSI-mx(E)/Rx safety interface checks the muting sensors for a valid state.

If the check ascertains a valid muting combination, the OSSDs will stay in the ON-state. The system takes on normal operation.

⚠ ATTENTION!	
	<p>If an invalid muting combination is detected, the release remains in effect only as long as the button is pressed. As soon as the button is released, the system comes to a standstill. Thus it is possible to enable and operate the system as long as a responsible person constantly observes the process and can interrupt the dangerous movement at any time by letting go of the start button. In this case, the muting sensors have to be checked for misalignment, contamination or damage.</p> <p>This option assumes that the start button is mounted in a location from which the entire danger zone can be viewed. See chapter 3.6 Additional safety notices for the special function "Muting".</p>

**4.3.2.7 Muting time limit - 10 minutes**

Regardless of the selected muting mode, the MSI safety interface reports a muting malfunction when the duration of a muting exceeds 10 minutes. Using parallel double muting, the OSSDs switch to the OFF-state and the MSI shows muting faults, when one of the two muting areas reaches the time limit. If a muting sequence is initiated within the 10 minutes, the timer is reset and the 10 minutes start over again.

⚠ ATTENTION!	
	<p>The muting time limit is mandatory. The muting time limit may only be switched off with DIP switch MU2 in the I/O-mx module in reasonable cases, e.g. for a normally uninterrupted flow of goods in the muting path and if no persons are thereby endangered.</p>

⚠ ATTENTION!	
	<p>The user assumes responsibility for switching off the muting time monitoring!</p>

**4.3.2.8 Example: Sequential muting, non-testable muting sensors**

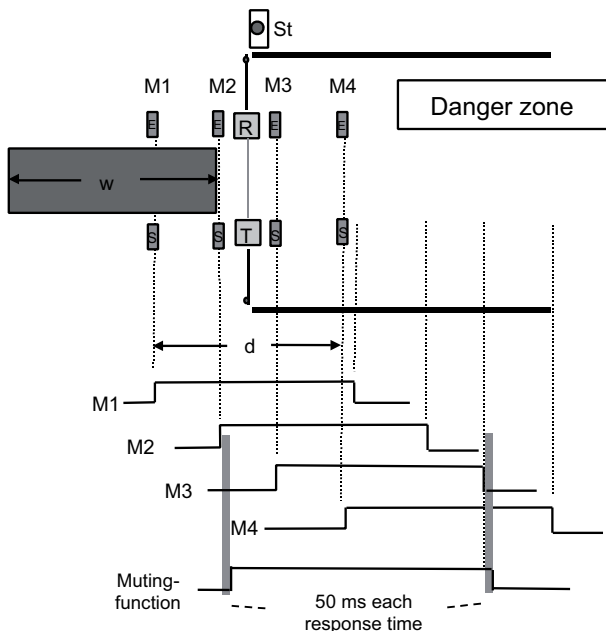

- Attention: Non-testable muting sensors. Shift DIP switch MU3 up
- Muting function effects the inputs S1 & S2. Change position of DIP switch MU4, if input S2 should not be muted. See chapter 4.2.2 DIP switch setting I/O-mx module.

T = AOPD transmitter

R = AOPD receiver

Piece = Start/restart, muting restart, must not be reachable out from the danger zone

- M1 to M4, non-testable muting sensors after transmitter/receiver operation deliver 24 V DC in the dampened state.
- Activation sequence: sequential without time monitoring. But: 10 min. time limit when muting has started
- $w$  = transport vehicle length,  $d$  = distance M1, M4, condition:  $w > d$
- Positioning of M2 and M3 as close as possible to the receiver, but consider 50 ms reaction time
- M1 to M4, symmetrical arrangement
- All muting sensors must be released before M1 (or M4 for reverse travel) is activated again.

#### 4.3.2.9 Example: Sequential muting, testable muting sensors

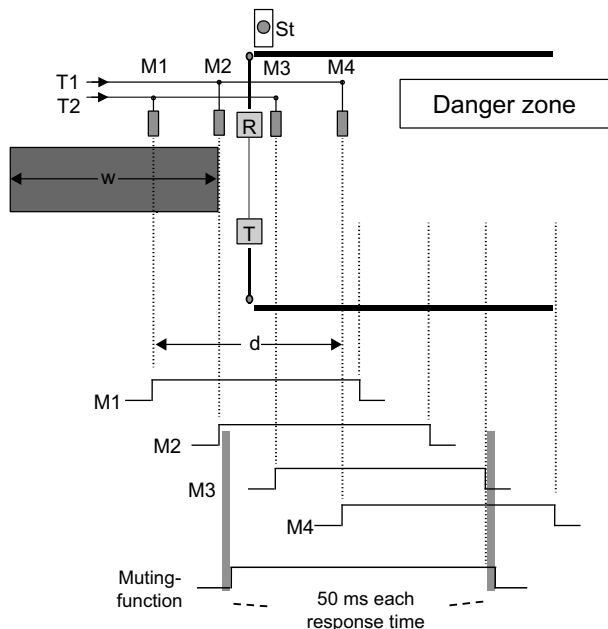

- Attention: Testable muting sensors. DIP switch MU3 down (factory setting)
- Muting function effects the inputs S1 & S2. Change position of DIP switch MU4, if input S2 should not be muted. See chapter 4.2.2 DIP switch setting I/O-mx module.

T = AOPD transmitter

R = AOPD receiver

Piece = Start/restart, muting restart, must not be reachable out from the danger zone

- T1, T2 test signal outputs
- M1 to M4, testable muting sensors according to the diffuse-reflection-sensor principle deliver 24 V DC and test signals in the dampened state.
- Activation sequence: sequential without time monitoring. But: 10 min. time limit when muting has started
- $w$  = transport vehicle length,  $d$  = distance M1, M4, condition:  $w > d$
- Positioning of M2 and M3 as close as possible to the receiver, but consider 50 ms reaction time
- M1 to M4, symmetrical arrangement
- All muting sensors must be released before M1 (or M4 for reverse travel) is activated again.

## 4.3.2.10 Example: Parallel muting, non-testable muting sensors

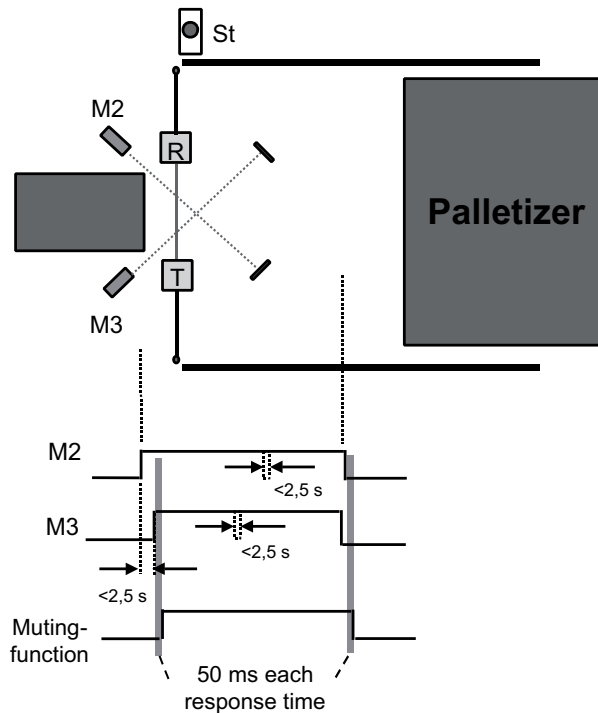

- Attention: Non-testable muting sensors. Shift DIP switch MU3 up
- Muting function effects the inputs S1 & S2. Change position of DIP switch MU4, if input S2 should not be muted. See chapter 4.2.2 DIP switch setting I/O-mx module.

T = AOPD transmitter

R = AOPD receiver

Piece = Start/restart, muting restart, must not be reachable out from the danger zone

- M2 and M3 = non-testable muting sensors  
The two retro-reflective photoelectric sensors with pnp output, dark-switching, provide 24 V DC in dampened state.
- Condition: Simultaneous activation of M2 and M3 within 2.5 s
- Muting is limited to 10 min. (time limit)
- Short interruptions of less than 2.5 s do not stop the muting function as long as only one muting sensor is affected.
- As soon as both of the muting sensors are falling back to 0 V, the muting function will end.
- Attention: The beams must intersect behind the protective field of the AOPD, i.e. within the danger zone. Symmetrical arrangement.

## 4.3.2.11 Example: Parallel muting, testable muting sensors

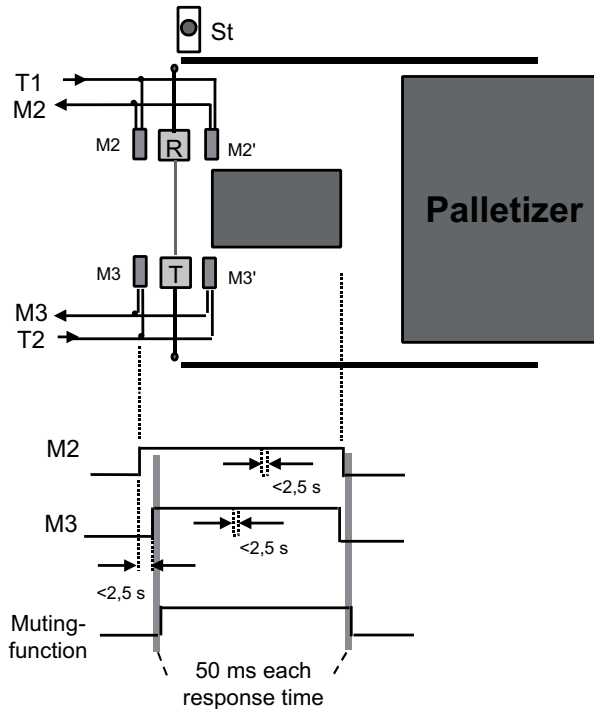

- Attention: Testable muting sensors. DIP switch MU3 down (factory setting)
- Muting function effects the inputs S1 & S2. Change position of DIP switch MU4, if input S2 should not be muted. See chapter 4.2.2 DIP switch setting I/O-mx module.

T = AOPD transmitter

R = AOPD receiver

Piece = Start/restart, muting restart, must not be reachable out from the danger zone

- T1, T2 test signal outputs
- M2 and M2', M3 and M3' = testable muting sensors  
The four diffuse reflection sensors with pnp output, light-switching, provide 24 V DC in dampened state.
- Condition: Simultaneous activation of M2, M3 or M2', M3' within 2.5 s
- Muting is limited to 10 min. (time limit)
- Short interruptions of less than 2.5 s do not stop the muting function as long as only one muting sensor is affected.
- As soon as both of the muting sensors are falling back to 0 V, the muting function will end.
- Positioning of M2, M2', M3 and M3' as close as possible to the receiver, but consider 50 ms reaction time. Symmetrical arrangement.

4.3.2.12 Example: Parallel double muting, non-testable muting sensors

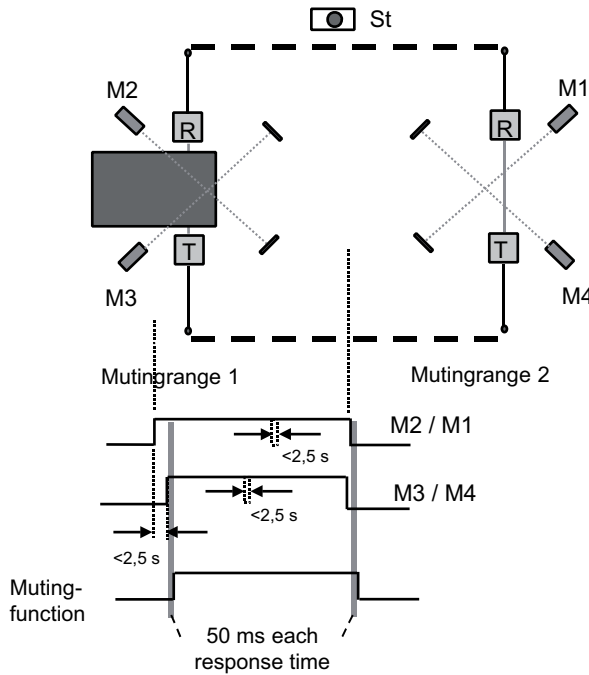

- Attention: Non-testable muting sensors. Shift DIP switch MU3 up
- Attention: Set parallel double muting. Shift DIP switch MU1 up.
- Muting function area 1 acts on inputs S1 & S2. DIP switch MU4 down (factory setting).
- Muting function area 2 acts on inputs S3 & S4. DIP switch MU5 down (factory setting).
- Change position of DIP switches MU4 and MU5, if S2 and S4 should not be muted (AOPDs of type 2). See chapter 4.2.2 DIP switch setting I/O-mx module.

T = AOPD transmitter

R = AOPD receiver

Piece = Start/restart, muting restart, must not be reachable out from the danger zone.

- M2 and M3 (or M1 and M4) non-testable muting sensors  
The four retro-reflective photoelectric sensors with pnp output, dark switching, deliver 24 V DC in the dampened state.
- Condition: simultaneous activation of M2 and M3 for muting area 1 within 2.5 s of each other or M1 and M4 for muting area 2 within 2.5 s of each other
- Muting is limited to 10 min. (time limit)
- Short interruptions of less than 2.5 s do not stop the muting function as long as only one muting sensor per area is affected.
- As soon as both of the muting sensors of an area are falling back to 0 V, the muting function will end for this area.
- Attention: The beams must intersect behind the protective field of the AOPD, i.e. within the danger zone. Symmetrical arrangement.

4.3.3 Safety door monitoring

During the risk analysis, it is also important to consider whether people can be enclosed and trapped in the danger zone if a transport vehicle is located in the muting path. The risk of crushing can still exist if there is a requirement to eliminate all access next to the vehicle during the muting process.

In such cases, wicket gates with safety door switches have proven useful. Unlike fixed elements, these extend to the transport vehicle. They yield to slight pressure and serve as an escape route, though they must be incorporated in the safety concept. Two safety doors with two switches each can be integrated into the safety circuit with the MSI-mx(E)/Rx. After the start button has been pressed, the precondition for

enabling operation is that the switches at 1.1 and 1.2 (or at 2.1 and 2.2) must have closed within 1 s of each other.

The connectable safety door switches can take over other tasks, such as monitoring rear doors or other accesses to the machine and switching off the machine as soon as these are opened. An E-STOP button can also be connected instead of a safety door switch. Safety door inputs **must** be connected. If no switches are connected to the MSI-mx(E)/Rx, bridges must simulate these connections accordingly.

**4.3.4 Relay switching cycle monitoring function with prefailure message (in /Rx versions)**

For purposes of preventive maintenance, the /Rx output assemblies are equipped with a function that counts the number of relay switching cycles and issues a prefailure message. Four different values can be selected at the DIP switches on the assembly. Before the DIP switches can be set, the Rx assembly must be released from its two holding brackets with a screwdriver and pulled slightly out of the housing.

The table below shows the recommended DIP switch settings with respect to the switching current. Switching voltages of up to 60 V DC and 250 V AC are admissible.

OSSD switching current (switching voltage 60 V DC, 250 V AC max.)	≤ 0.75 A	> 0.75 A ≤ 1.5 A	> 1.5 A ≤ 3 A	> 3 A ≤ 5 A
Recommended number of switching cycles	1,000,000	500,000	200,000	100,000

For DIP switch settings, see chapter 4.2.3

**4.4 Indicators**

A number of LEDs of various colors indicate the operating state of the MSI modular safety interface. It is also possible to show the indicators and input/output states on the PC monitor using the integrated RS 232 interface and diagnostic connector.

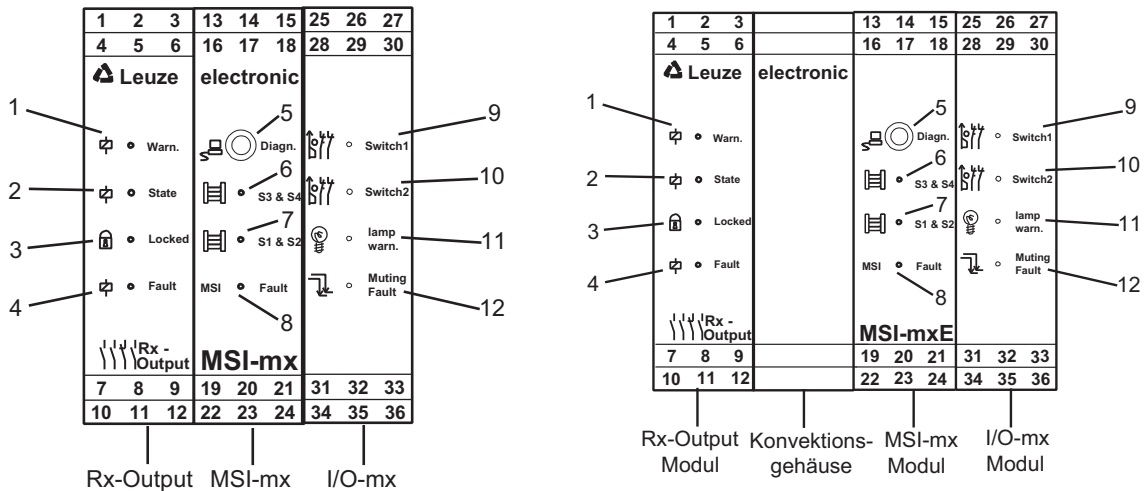

Output /Rx					
Position	Display/function	Icon	Status	LED	Color
1	Relay switching cycles	Relay/Warn	Reached Not reached	On Off	Red
2	Switching state Safety output	Relay	On Off	On On	Green Red
3	Start/restart interlock	Lock	Locked Not locked	On Off	Yellow
4	Error in output module	Relay	Error No error	On Off	Red



MSI-mx module					
Position	Display/function	Icon	Status	LED	Color
5	Diagnosis, RS 232 See signal outputs	Socket Diagn.	N/A	N/A	N/A
6	Protective field	AOPDs S3 & S4	Protective field free Not free	On Off	Green
7	Protective field	AOPDs S1 & S2	Protective field free Not free	On Off	Green
8	MSI error	MSI Fault	Error No error	On Off	Red

I/O-mx module					
Position	Display/function	Icon	Status	LED	Color
9	Safety switches 1.1-1.2	Contacts Switch	Both closed* Not closed	On Off	Green
10	Safety switches 2.1-2.2	Contacts Switch	Both closed* Not closed	On Off	Green
11	Muting indicators	Broken fil- ament Short- circuit Interrup- tion	Defect indicator 1 Defect indicator 2 No defect	Flashes 1x Flashes 2x Off	Red Red
12	Muting error	Sequence error	Error No error	On Off	Red

\* Both switches must be closed within 1 s of each other

### 4.5 Signal outputs

**⚠ ATTENTION!**

**⚠** Signal outputs are not allowed to be used as safety-related signals in release circuits (see also chapter Safety Notices, Operating conditions and approved purpose).

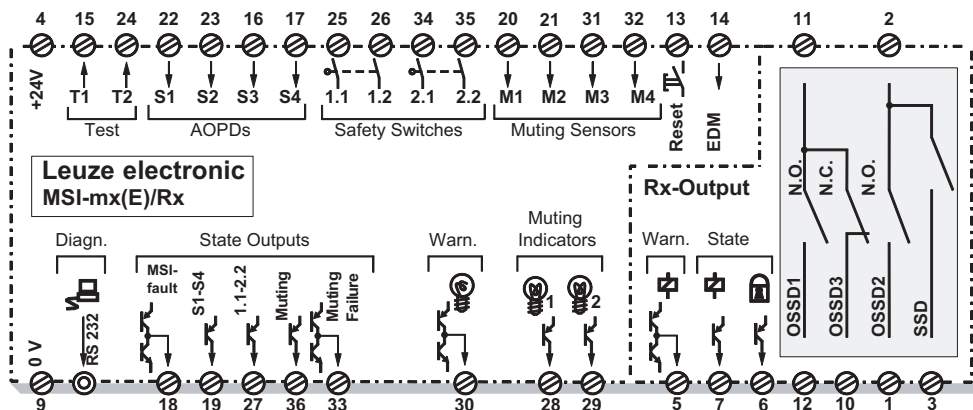

Output /Rx				
Terminal	Signaling function	Icon	Status	Signal output
5	Warning output switching cycles	Relay	Not reached Reached	Active high Active low
6	Start/restart interlock	Lock	Locked Not locked	Active high Active low
7	Switching state Safety output	Relay	ON OFF	Active high Active low

MSI-mx module				
Terminal	Signaling function	Icon	Status	Signal output
Front socket	Diagnosis, RS 232 2.5 mm connector	–	–	Connection to PC with diagnosis program
18	MSI error	MSI Fault	No error Error	Active high Active low
19	Protective field(s)	S1 - S4	Free Not (all) free	Active high Active low

I/O-mx module				
Terminal	Signaling function	Icon	Status	Signal output
27	Safety doors 1.1 to 2.2	1.1-2.2	Closed Not closed	Active high Active low
28*	Muting indicators 24 V DC, 5 W max.	Lamp	Muting on Muting off	Active high Active low
29*	Muting indicators 24 V DC, 5 W max.	Lamp	Muting on Muting off	Active high Active low
30	Warning Muting indicator defective	Broken filament Short-circuit Interruption	Indicator OK Defect indicator 1 Defect indicator 2	Active high Impulse 1x Impulse 2x
33	Muting error	Muting Failure	No error Muting error	Active high Active low
36	Muting status	Muting	Muting on Muting off	Active high Active low

\*Terminal 29 as backup

Terminal 28 muting area 1  
Terminal 29 muting area 2

#### 4.6 Diagnostics function

Requirements for running the diagnosis system: a standard PC or laptop operating under Windows (Version 3.1 or higher) and the MSI software, Version 01, as well as a serial connection cable and a 2.5 mm jack plug.

- Simultaneous display of all input and output states as well as all LED displays on the MSI

With its diagnosis interface, the intelligent modular safety interface MSI offers a convenient way to visualize all of the input and output states simultaneously on the monitor. The connection diagram as well as display fields in different colors can be shown via the connection terminals. A graphic representation of the MSI front design with the display elements as described in chapter 4.4 also appears on the screen.

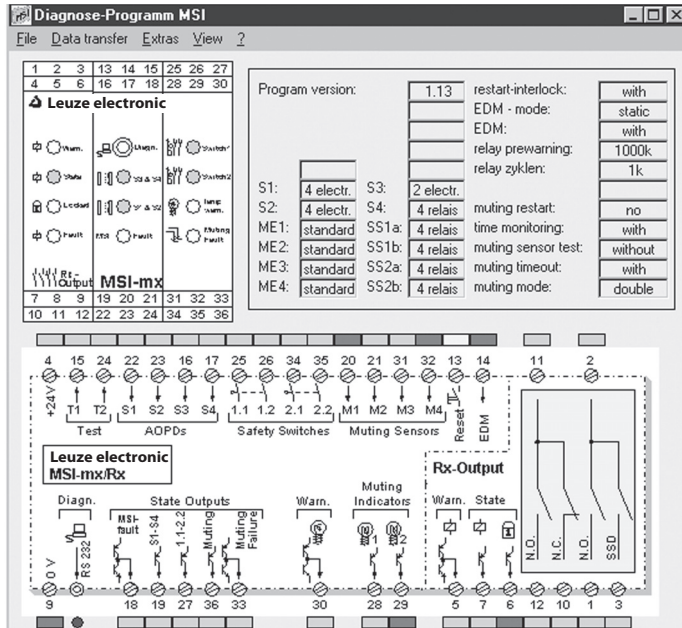

Example:



This enables the sequences at individual screw terminals to be tracked without the use of additional measuring instruments. The diagnostics function is equipped with online help and can be operated in either English or German.

## 5 Electrical connection

### 5.1 Installation instructions

⚠ ATTENTION!	
	The general Safety Notices in chapter 3 must be observed. The electrical installation may only be performed by trained specialists and if there is no voltage applied.
⚠ ATTENTION!	
	In the R/Rx versions, it is possible that high voltages may be applied at the output contacts. A de-energized state is achieved only when the 24 V DC supply voltage as well as the supply lines to the switching contacts are safely switched off and secured against being switched on again.
⚠ ATTENTION!	
	Coded plug-in terminal blocks allow a connection cross-section of up to 2.5 mm <sup>2</sup> . The supply voltage must be externally fused against overcurrent with a fuse of 2.5 A mT. The switching contacts must also be externally fused against overcurrent with a maximum of 4 A gG. This prevents the safety-related contacts from welding together if the current load is too high!

### 5.2 Power supply requirements

⚠ ATTENTION!	
	<p>The supply voltage of 24 V DC must guarantee safe mains separation and be able to bridge a voltage dip of 20 ms at full load. The functional earth connection of the MSI is established when snapped onto the grounded metal mounting rail via the rear clamping device.</p> <p>↳ The supply line for the supply voltage must be externally fused against overcurrent with a maximum of 2.5 A mT.</p>

### 5.3 Connecting AOPDs, type 4 or type 2

The examples below show possibilities for connecting and combining AOPDs of various safety categories and with various output features (relays, safety-oriented transistor outputs, cross circuit monitoring within and outside the AOPD).

AOPDs of type 4 with transistor outputs and cross circuit monitoring function can be connected directly to the safety inputs S1 and S2 of S3 and S4. See example 1.

**All available safety inputs must be occupied!** In case no components are connected, the remaining sensor inputs must be connected to the corresponding test signal using bridges. In doing so, please note that the even-numbered test signal must be connected to the even-numbered sensor input via the non-delaying bridge (T2 => S2 or S4) and vice versa (T1 => S1 or S3). See example 2.

AOPDs of type 4 with relay outputs, safety switches or E-STOP buttons must be connected so that the odd-numbered test signal T1 is directed via the non-delaying contacts to the odd-numbered sensor inputs (T1 => S1 or S3) and vice versa (T2 => S2 and S4). See examples 3 and 4.

AOPDs of type 2 are periodically tested using the time-delayed test signals T1 or T2. The even-numbered test signal must be directed to an odd-numbered safety input via the time-delaying sensor (T2 => S1 or S3) and vice versa (T1 => S2 and S4). The sensor response time to a test request must be in a range of 2 to 18 ms. See examples 5 and 6.

⚠ ATTENTION!	
	Using both the inputs S1 & S2 and S3 & S4, separate insulated supply lines must be used because cross circuits are monitored between S1 and S2 as well as S3 and S4, not, however, between S1 and S3 and S2 and S4.

If type 2 AOPDs are connected:

- According to EN 61496-1, only a maximum of PL c or SIL CL 1 can be achieved!
- When cables are laid without protection (e.g. S1 & S2 only or S3 & S4 only), an error detection time of up to 10 s is possible.

**Example 1**

2 AOPD of type 4 with 2 safety-related transistor outputs each and internal cross circuit monitoring function.

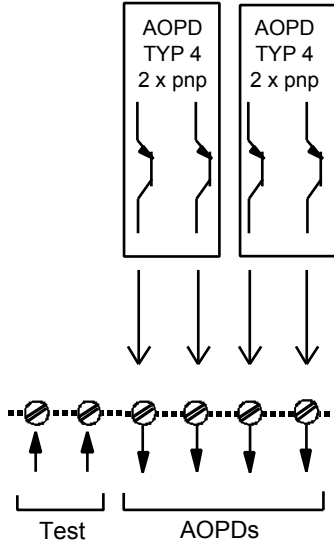

**Example 2**

1 AOPD of type 4 with 2 safety-related transistor outputs and internal cross circuit monitoring function.

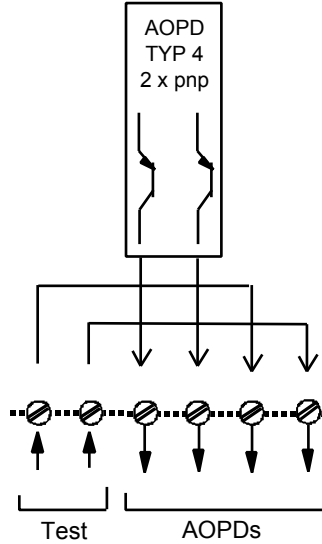

**Example 3**

2 AOPD of type 4 with 2 normally open contacts each. Separated connection cables to the individual AOPDs are required.

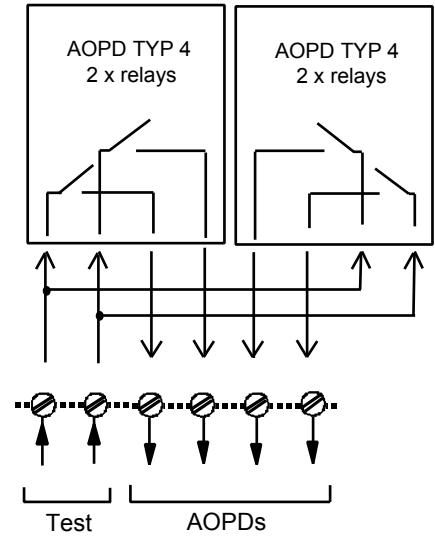

**Example 4**

1 AOPD of type 4 with 2 normally open contacts and door safety switch. Separated connection cables to the AOPD and the safety switch are required.

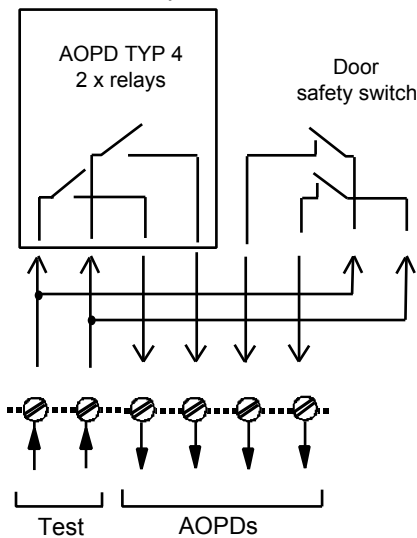

**Example 5**

3 AOPD of type 2 with one safety-related transistor output each. Separated connection cables to the individual AOPDs are required.

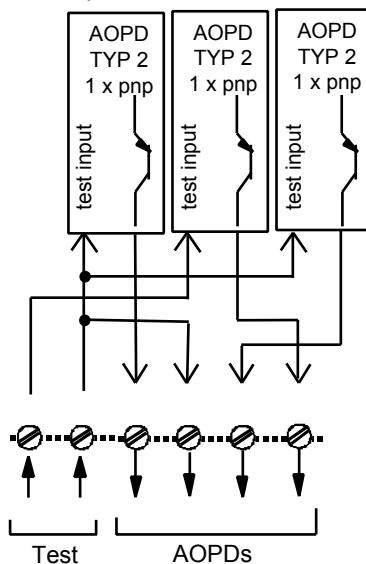





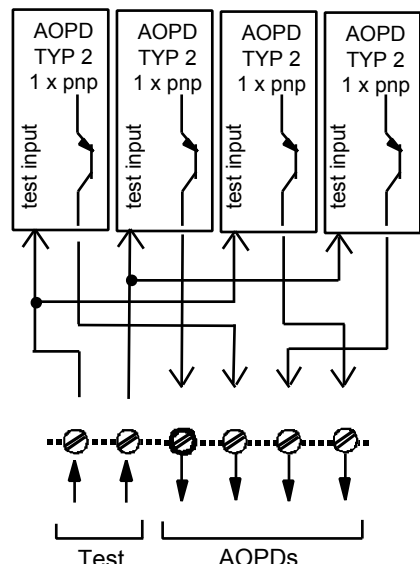

**Example 6**

4 AOPD of type 2 with one safety-related transistor output each. Separated connection cables to the individual AOPDs are required.



5.4 Connecting to the machine control

 <b>ATTENTION!</b>	
	<p>The safety-related parts of the controls comprise more than the MSI-mx(E)/Rx described above. They also include successive control elements and even power transmission elements which must be safely and promptly shut down. Special attention must be given here to the adherence to the required safety category. Important information on this topic can be found in EN ISO 13849-1:2015.</p>
 <b>ATTENTION!</b>	
	<p>Essential prerequisites for safe operation are the abilities to electrically influence the interruption of the dangerous movement and to bring the machine to a standstill as quickly as possible. These factors, as well as the reaction times of AOPDs and the MSI, must be taken into consideration when calculating the safety distance.</p> <p>The reaction times depend on the type of AOPD selected (see chapter 7, Technical data). Other parameters, such as access speed or additional distance to be added to the safety distance, are dependent on the respective applications and the resolution of the used AOPD. European standard EN ISO 13855 includes calculation formulas and examples for various arrangements.</p>
 <b>ATTENTION!</b>	
	<p>Impairment of the protective function due to faulty muting signals with 2-sensor parallel muting!</p> <p>↪ Note the order of the ground connections! The ground connection of the MSI-mx(E)/Rx (0 V/ terminal 9) must be wired between the ground connections of muting sensors M2 and M3. For the muting sensors and the safety sensor, a shared power supply unit is to be used. The connection lines of the muting sensors must be laid separated from one another and protected.</p>

## 6 Connection examples

The connection example below shows one wiring suggestion for the MSI-mx(E)/Rx.

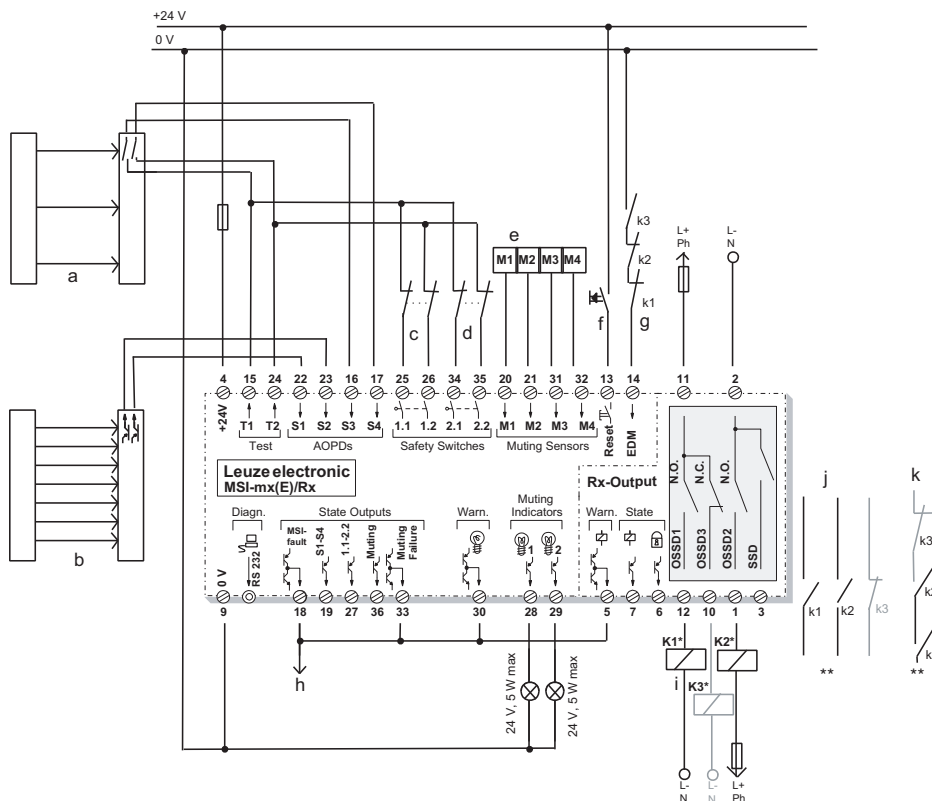

Connection example MSI-mx(E)/Rx with two AOPD of type 4 and two safety switches

- a = AOPD type 4 with protective function
- b = AOPD type 4 with protective and muting function
- c = Safety switch 1 (or E-STOP button)
- d = Safety switch 2
- e = M1, M2, M3, M4, non-testable muting sensors (i.e. throughbeam photoelectric sensors), sequential muting
- f = Command device for release (start/restart interlock)
- g = Feedback circuit for contactor monitoring
- h = Possible collector cable for warning/error indications
- Pin 18 = Signal output "MSI error"
- Pin 19 = Signal output "sensor state"
- Pin 27 = Signal output "safety switches status"
- Pin 36 = "Muting state" signal output
- Pin 33 = Signal output "muting error"
- Pin 30 = Warning output "Muting indicator defective"
- Pin 28/29 = Outputs muting indicators 1 and 2
- Pin 5 = Relay prefailure message
- Pin 7 = Signal output "switching state of safety output "
- Pin 6 = Signal output "interlock state"
- i = Safety-related switching outputs (OSSDs)
- Pin 3 = Secondary switch-off circuit SSD (opens in case of MSI failure)

- j = Two-channel (three-channel) release circuit
- k = One-channel release circuit
- \* = Use suitable spark extinction circuits
- \*\* = Always use at least two contacts in the release circuit. Only use sequential contactors with positive-guided contacts.

**All available safety inputs must be occupied!**

See chapter 5.3.



## 7 Technical data and order guide

### 7.1 MSI-mx(E)

Version, type Modular Safety Interface	MSI-mx(E)
Type in accordance with EN 61496-1	Type 4
SIL in accordance with EN 61508	SIL 3
Performance Level (PL) in accordance with EN ISO 13849-1:2015	PL e
Category in accordance with EN ISO 13849-1:2015	Cat. 4
Mean probability of a dangerous failure per hour (PFH <sub>d</sub> ) as a function of the mean number of annual switching cycles of the relay n <sub>op</sub> *	100% Load n <sub>op</sub> = 4,800: 1.6 x 10 <sup>-08</sup> 1/h 60% Load n <sub>op</sub> = 4,800: 1.3 x 10 <sup>-08</sup> 1/h 100% Load n <sub>op</sub> = 28,800: 3.8 x 10 <sup>-08</sup> 1/h 60% Load n <sub>op</sub> = 28,800: 1.6 x 10 <sup>-08</sup> 1/h 100% Load n <sub>op</sub> = 86,400: 9.5 x 10 <sup>-08</sup> 1/h 60% Load n <sub>op</sub> = 86,400: 2.4 x 10 <sup>-08</sup> 1/h
Number of cycles until 10% of the components have a failure to danger (B10 <sub>d</sub> )	400,000: 100% of the max. switching current of loading cases AC1, DC1, AC15, DC13 2,500,000: 60% of the max. switching current of loading cases AC1, DC1, AC15, DC13 20,000,000: 20% of the max. switching current of loading cases AC1, DC1, AC15, DC13
Mission time (T <sub>M</sub> )	20 years
Connectable safety sensors at S1 - S4	Up to 2 AOPD of type 4, type 3 or up to 4 AOPDs of type 2 (all in acc. with EN 61496-1)
Connectable safety switches and command devices at 1.1-2.2	Interlock devices according to EN ISO 14119 Area E-STOP button according to EN ISO 13850
Test outputs T1 and T2, test interval  Test impulse duration, time-delayed Reaction time, AOPD of type 2 on test request	200 ms 24 ms each 2 to 18 ms
Available functions	Start/restart interlock Contactor monitoring Sequential muting Parallel muting (2.5 s) Parallel double muting (2.5 s)
Control input Start/restart interlock (reset)	Potential-free normally open contact (button or key switch)
Control input Contactor monitoring (EDM)	Feedback of positive-guided contacts of sequential contactors (see connection diagram)
Control inputs of muting sensors M1 - M4 (separate connection cables required!) Connection of non-testable muting sensors (dark switching) Connection of testable muting sensors (light switching) Reaction time of testable muting sensors to a test request	Signal level in dampened state:  Active high, 24 V DC  Active low, 24 V DC, plus test impulses from T1 or T2  2 to 18 ms



\* $n_{op}$  = mean number of annual actuations, see C.4.2 and C.4.3 of EN ISO 13849-1:2015  
 Use the following formula to calculate the mean number of annual actuations:

$$n_{op} = (d_{op} \cdot h_{op} \cdot 3600 \text{ s/h}) \div t_{Zyklus}$$



In doing so, make the following assumptions with regard to the use of the component:

$h_{op}$  = mean operating time in hours per day

$d_{op}$  = mean operating time in days per year

$t_{cycle}$  = mean operating time between the start of two successive cycles of the component (e.g switching of a valve) in seconds per cycle

## 7.2 /Rx output

OSSD safety outputs	2 safety-related normally open contacts, 60 V DC, 250 V AC, 5 A max. 1 safety-related normally closed contact, 60 V DC, 250 V AC, 5 A max.			
Switching voltage/switching current	Minimum switching current 20 mA			
Safety outputs protection class	II			
Rating voltage for safety outputs	Overvoltage category 3 / 300 V AC			
OSSD external fuse (EN 60269-1)	4 A gG D-fuse			
Contact currents (EN 60947-5-1)	AC15, 3 A DC13, 2 A			
OSSD reaction time MSI (without AOPD)	For AOPD type 4, transistor output	22 ms		
	For AOPD type 4, relay output	64 ms		
	For AOPD type 2	64 ms		
	For safety switches (electro-mechanical)	64 ms		
OSSD restart delay time	> 100 ms			
OSSD-suitable spark extinction via the coils of the downstream relays	Required			
SSD secondary switching device (closes after successful MSI start test, opens in case of failure) Switching voltage/switching current	1 normally open contact,  60 V DC, 250 V AC, 5 A max. Minimum switching current 20 mA			
SSD external fuse SSD (Secondary Switching Device) not to be used for safety circuit! 	5 A mT			
Do not use "Status of switching outputs" signal output for safety circuit! 	pnp switching output			
	OSSDs ON state:	Active high, 24 V DC,	100 mA max.	
	OSSDs OFF state:	Active low		
Signal output "State of start/restart interlock"	pnp switching output			
	Locked:	Active high, 24 V DC,	100 mA max.	
	Not locked:	Active low		
OSSD currents over the contacts at 230 V AC switching voltage	≤ 0.75 A	> 0.75 A ≤ 1.5 A	> 1.5 A ≤ 3 A	> 3 A ≤ 5 A
Recommended limit of switching cycles can be set via DIP switch of Rx module (factory setting 1,000,000)	1,000,000	500,000	200,000	100,000

<p>Signal output</p> <p>"Warning – Preset switching cycles reached"</p>	<p>Push-pull transistor output</p> <p>Switching cycles not reached: Active high, 24 V DC, 60 mA</p> <p>Switching cycles reached: Active low</p>
---	---

7.3 Dimensioned drawing

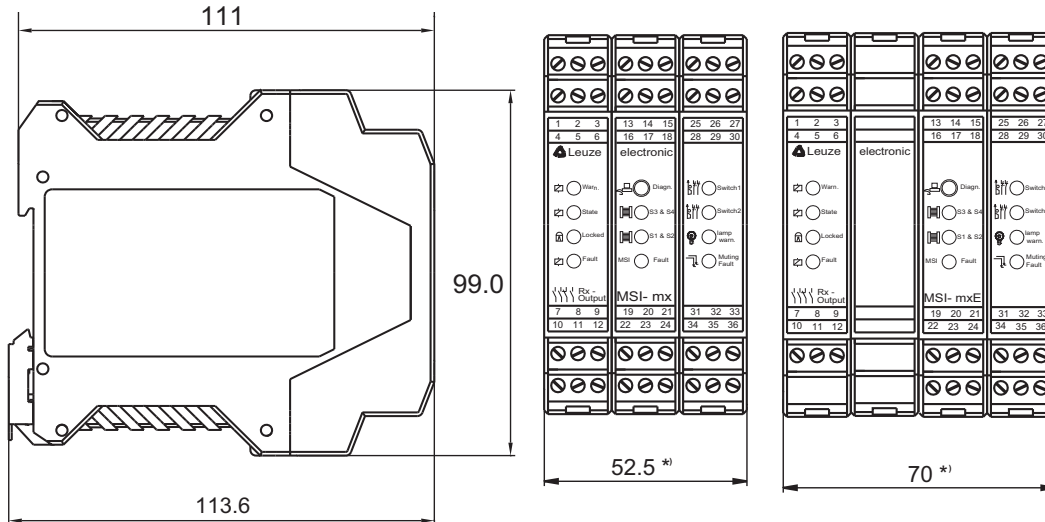

\*) Stringing together without distance possible

7.4 Order guide

Type	Order no.
MSI-mx/Rx	549905
MSI-mxE/Rx	549982
MSI diagnostic software	549930
Diagnostics cable 3 m	549953
Diagnostics cable 5 m	549955
/Rx output assembly (replacement part)	509211

8 EC Declaration of Conformity



**EU-/EG-  
KONFORMITÄTS-  
ERKLÄRUNG**

**EU/EC  
DECLARATION OF  
CONFORMITY**

**DECLARATION  
UE/CE DE  
CONFORMITE**

Hersteller:

Manufacturer:

Constructeur:

**Leuze electronic GmbH + Co. KG**  
In der Braike 1, PO Box 1111  
73277 Owen, Germany

Produktbeschreibung:

Description of product:

Description de produit:

**Modulares Sicherheits-  
Interface**  
**MSI (-s, -sx), (-i, -ix), (-m, -mx),  
(-mE, -mxE)**  
**Serien Nr. siehe Typenschild**

**Modular Safety Interface**  
**MSI (-s, -sx), (-i, -ix), (-m, -mx),  
(-mE, -mxE)**  
**Serial no. see name plate**

**Module d'interface de sécurité**  
**MSI (-s, -sx), (-i, -ix), (-m, -mx),  
(-mE, -mxE)**  
**numéro de série voir  
plaque signalétique**

Die alleinige Verantwortung für die Ausstellung dieser Konformitätserklärung trägt der Hersteller.

This declaration of conformity is issued under the sole responsibility of the manufacturer.

La présente déclaration de conformité est établie sous la seule responsabilité du fabricant.

Der oben beschriebene Gegenstand der Erklärung erfüllt die einschlägigen Harmonisierungsrechtsvorschriften der Union:

The object of the declaration described above is in conformity with the relevant Union harmonisation legislation:

L'objet de la déclaration décrit ci-dessus est conforme à la législation d'harmonisation de l'Union applicable:

Angewandte EU-/EG-  
Richtlinie(n):  
2006/42/EG (\*1)  
2014/30/EU

Applied EU/EC Directive(s):  
2006/42/EC (\*1)  
2014/30/EU

Directive(s) UE/CE  
appliquées:  
2006/42/CE (\*1)  
2014/30/UE

Angewandte harmonisierte Normen / Applied harmonized standards / Normes harmonisées appliquées:  
EN ISO 13849-1:2015 (\*1) EN ISO 13849-2:2012 EN 62061:2005  
EN 60204-1:2006+AC:2010+A1:2009 +AC:2010+A1:2013+A2:2015

Angewandte technische Spezifikationen / Applied technical specifications / Spécifications techniques appliquées:  
EN 61496-1:2013+AC2015 (\*1)

**Notified Body**

(\*1) TÜV SÜD Product Service GmbH, Certification Body, Ridlerstraße 65, D-80339 Munich, NB 0123, Z10 068636 0038 Rev. 00  
Dokumentationsbevollmächtigter ist der genannte Hersteller, Kontakt: quality@leuze.de.  
Authorized for documentation is the stated manufacturer, contact: quality@leuze.de.  
Autorisé pour documentation est le constructeur déclaré, contact: quality@leuze.de  
2014/30/EU veröffentlicht: 29.03.2014, EU-Amtsblatt Nr. L 96/79-106; 2014/30/EU published: 29.03.2014, EU-Journal No. L 96/79-106; 2014/30/UE publié: Journal EU n° L 96/79-106

30.06.2020  
Datum / Date / Date

Dr. Albrecht Pfeil  
Director Business Unit Safety

i.A. Alexander Mielchen  
Product Manager Safety

Leuze electronic GmbH + Co. KG  
In der Braike 1  
D-73277 Owen  
Telefon +49 (0) 7021 573-0  
Telefax +49 (0) 7021 573-399  
info@leuze.de  
www.leuze.com  
LEO-ZQM-148-07-FO

Leuze electronic GmbH + Co. KG, Sitz Owen, Registergericht Stuttgart, HRA 230712  
Persönlich haftende Gesellschafterin Leuze electronic Geschäftsführungs-GmbH,  
Sitz Owen, Registergericht Stuttgart, HRB 230550  
Geschäftsführer: Ulrich Balbach  
USI-IdNr: DE 145912521 | Zollnummer 2554232  
Es gelten ausschließlich unsere aktuellen Verkaufs- und Lieferbedingungen  
Only our current Terms and Conditions of Sale and Delivery shall apply

**DICHIARAZIONE DI  
CONFORMITÀ  
UE/CE**

**DECLARACIÓN DE  
CONFORMIDAD  
UE/CE**

**DECLARAÇÃO DE  
CONFORMIDADE  
UE/CE**

Fabbricante:

Fabricante:

Fabricante:

**Leuze electronic GmbH + Co. KG  
In der Braike 1, PO Box 1111  
73277 Owen, Germany**

Descrizione del prodotto:

Descripción del producto:

Descrição do produto:

**Interfaccia di sicurezza  
modulare  
MSI (-s, -sx), (-i, -ix), (-m, -mx),  
(-mE, -mxE)  
Numero di serie vedi etichetta  
del tipo**

**Interfaz de seguridad modular  
MSI (-s, -sx), (-i, -ix), (-m, -mx),  
(-mE, -mxE)  
Número de serie ver etiqueta  
de tipo**

**Interface de segurança  
modular  
MSI (-s, -sx), (-i, -ix), (-m, -mx),  
(-mE, -mxE)  
Número de série veja etiqueta  
de tipo**

La responsabilità per l'emissione della presente dichiarazione di conformità è esclusivamente a carico del fabbricante.

El único responsable de la expedición de esta declaración de conformidad es el fabricante.

A responsabilidade pela emissão desta declaração de conformidade é exclusivamente do fabricante.

Il summenzionato oggetto della dichiarazione è conforme alle norme armonizzate applicabili dell'Unione:

El objeto de la declaración arriba descrito cumple la legislación comunitaria de armonización pertinente:

O objeto da declaração descrito acima cumpre os regulamentos legais de harmonização aplicáveis da União Europeia:

Direttiva(e) UE/CE  
applicata(e):  
2006/42/CE (\*1)  
2014/30/UE

Directiva(s) UE/CE  
aplicada(s):  
2006/42/CE (\*1)  
2014/30/UE

Directiva(s) UE/CE aplicada(s):  
2006/42/CE (\*1)  
2014/30/UE

Norme armonizzate applicate / Normas harmonizadas aplicadas / Normas harmonizadas aplicadas:  
EN ISO 13849-1:2015 (\*1) EN ISO 13849-2:2012 EN 62061:2005  
EN 60204-1:2006+AC:2010+A1:2009 +AC:2010+A1:2013+A2:2015

Specifiche tecniche applicate / Especificaciones técnicas aplicadas / Especificações técnicas aplicadas:  
EN 61496-1:2013+AC2015 (\*1)

**Notified Body**

(\*1) TUEV SÜED Product Service GmbH, Certification Body, Ridlerstraße 65, D-80339 Munich, NB 0123, Z10 068636 0038 Rev. 00

Il responsabile per la documentazione è il fabbricante nominato, contatto: quality@leuze.de.

El apoderado de la documentación es el nombrado fabricante, contacto: quality@leuze.de.

O responsável pela documentação é o fabricante especificado, contato: quality@leuze.de.

2014/30/UE data di pubblicazione: 29.03.2014, Gazzetta ufficiale dell'Unione europea n. L 96/79-106; 2014/30/UE publicado: 29.03.2014, Diario Oficial de la Unión Europea L 96/79-106; 2014/30/UE publicado: 29.03.2014, Jornal Oficial da União Europeia L 96/79-106

30.06.2020

Data / Fecha / Data



ppa. Dr. Albrecht Pfeil  
Director Business Unit Safety



i.A. Alexander Mielchen  
Product Manager Safety

Leuze electronic GmbH + Co. KG  
In der Braike 1  
D-73277 Owen  
Telefon +49 (0) 7021 573-0  
Telefax +49 (0) 7021 573-199  
info@leuze.de  
www.leuze.com

LEO-ZQM-148-07-FO

Leuze electronic GmbH + Co. KG, Sitz Owen, Registergericht Stuttgart, HRA 230712  
Parsónlich haftende Gesellschafterin Leuze electronic Geschäftsührungs-GmbH,  
Sitz Owen, Registergericht Stuttgart, HRB 230550  
Geschäftsführer: Ulrich Balbach  
USt-IdNr. DE 145912521 | Zollnummer 2554232  
Es gelten ausschließlich unsere aktuellen Verkaufs- und Lieferbedingungen  
Only our current Terms and Conditions of Sale and Delivery shall apply

EU/EC 符合性声明

EU/EC 준수선언서

EU-/EG-VERKLARING  
VAN  
OVEREENSTEMMING

制造商:

제조업체:

Fabrikant:

**Leuze electronic GmbH + Co. KG**  
In der Braike 1, PO Box 1111  
73277 Owen, Germany

产品介绍:

제품 설명:

Productbeschrijving:

模块化安全接口  
**MSI (-s, -sx), (-i, -ix), (-m, -mx),  
(-mE, -mxE)**  
序列号请参见类型标签

모듈 식 보안 인터페이스  
**MSI (-s, -sx), (-i, -ix), (-m, -mx),  
(-mE, -mxE)**  
일련 번호 유형 라벨 참조

**Modulaire beveiligingsinterface**  
**MSI (-s, -sx), (-i, -ix), (-m, -mx),  
(-mE, -mxE)**  
Serienummer zie typeplaatje

制造商对于本一致性声明的签  
发承担唯一的责任。

이 준수선언서는 제조업체의  
단독 책임으로  
발행되었습니다.

De verantwoordelijkheid voor  
het opstellen van deze  
conformiteitsverklaring ligt  
uitsluitend bij de fabrikant.

本声明的上述适用对象符合欧  
盟的统一立法规定:

위에서 설명한 선언 대상은  
조합의 해당 지역 조화 규정을  
준수합니다.

Het hierboven  
gespecificeerde voorwerp van  
de verklaring voldoet aan de  
van toepassing zijnde  
geharmoniseerde wettelijke  
voorschriften van de  
Europese Unie:

应用的 EU/EC 指令:

적용된 EU/EC 지침:

Toegepaste EU-/EG-  
richtlijn(en):

2006/42/EC (\*1)  
2014/30/EU

2006/42/EU (\*1)  
2014/30/EU

2006/42/EG (\*1)  
2014/30/EU

应用统一标准 / 적용 조화 표준 / Toegepaste geharmoniseerde normen:

EN ISO 13849-1:2015 (\*1)  
EN 60204-1:2006+AC:2010+A1:2009

EN ISO 13849-2:2012

EN 62061:2005  
+AC:2010+A1:2013+A2:2015

应用技术规范 / 응용 기술 사양 / Toegepaste technische specificaties:

EN 61496-1:2013+AC2015 (\*1)

Notified Body

(\*1) TÜEV SÜED Product Service GmbH, Certification Body, Ridlerstraße 65, D-80339 Munich, NB 0123, Z10 068636 0038 Rev. 00

文档授权代理人为上述制造商 - 联系方式: quality@leuze.de.

문서 공인 책임자는 언급된 제조업체입니다. 연락처: quality@leuze.de.

Gevoelmachtigde voor de documentatie is de genoemde fabrikant, contact: quality@leuze.de.

2014/30/EU 颁布日期: 2014 年 3 月 29 日. 欧盟官方公报编号 L 96/79-106; 2014/30/EU 발행: 2014.03.29, EU 공식 관보 No. L 96/79-106; 2014/30/EU gepubliceerd: 29-03-2014, EU publicatieblad nr. L 96/79-106

30.06.2020

日期 / 날짜 / Datum

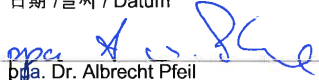
  
Dr. Albrecht Pfeil  
Director Business Unit Safety

  
i.A. Alexander Mielchen  
Product Manager Safety

Leuze electronic GmbH + Co. KG  
In der Braike 1  
D-73277 Owen  
Telefon +49 (0) 7021 573-0  
Telefax +49 (0) 7021 573-199  
info@leuze.de  
www.leuze.com

Leuze electronic GmbH + Co. KG, Sitz Owen, Registergericht Stuttgart, HRA 230712  
Persönlich haftende Gesellschafterin Leuze electronic Geschäftsführungs-GmbH,  
Sitz Owen, Registergericht Stuttgart, HRB 230560  
Geschäftsführer: Ulrich Balbach  
USt-IdNr. DE 145912521 | Zollnummer 2554232  
Es gelten ausschließlich unsere aktuellen Verkaufs- und Lieferbedingungen  
Only our current Terms and Conditions of Sale and Delivery shall apply

LEO-ZQM-148-07-F0