

Original operating instructions

## MSI-TR1B MSI-TR2B

Safety Relays



© 2021

Leuze electronic GmbH + Co. KG

In der Braike 1

D-73277 Owen / Germany

Phone: +49 7021 573-0

Fax: +49 7021 573-199

<http://www.leuze.com>

[info@leuze.de](mailto:info@leuze.de)

<b>1</b>	<b>About this document.</b>	<b>5</b>
1.1	Used symbols and signal words	5
1.2	Checklists	5
<b>2</b>	<b>Safety</b>	<b>6</b>
2.1	Intended use and foreseeable misuse	6
2.1.1	Intended use	6
2.1.2	Foreseeable misuse	7
2.2	Competent persons	7
2.3	Responsibility for safety	7
2.4	Exemption of liability	8
<b>3</b>	<b>Device description</b>	<b>9</b>
3.1	Device overview	10
3.2	Display elements	10
<b>4</b>	<b>Functions</b>	<b>12</b>
4.1	Start/restart interlock (RES)	12
4.2	Contacting monitoring (EDM)	12
<b>5</b>	<b>Applications</b>	<b>13</b>
5.1	Access guarding	13
<b>6</b>	<b>Mounting</b>	<b>15</b>
6.1	Arrangement of the protective device	15
6.1.1	Calculating the safety distance	15
6.1.2	Multi-axis arrangement	16
6.1.3	Minimum distance to reflective surfaces	16
6.1.4	Checklist – mounting the protective sensor	18
<b>7</b>	<b>Electrical connection</b>	<b>20</b>
7.1	Terminal assignments	20
7.2	Configuration of the EDM and RES operating modes	21
7.3	Circuit diagram examples	22
<b>8</b>	<b>Starting up the device</b>	<b>24</b>
8.1	Switching on	24
8.2	Unlocking start/restart interlock (RES)	24
<b>9</b>	<b>Testing</b>	<b>25</b>
9.1	Before the initial start-up and following modifications	25
9.1.1	Checklist – initial start-up	25
9.2	To be performed periodically by a competent person	26
9.3	To be performed daily by the operating personnel	27
9.3.1	Check list – daily or at change of shift	27
<b>10</b>	<b>Maintenance</b>	<b>28</b>
<b>11</b>	<b>Troubleshooting</b>	<b>29</b>
11.1	What to do in case of failure?	29
11.2	Operating indicators of the LEDs	29

<b>12</b>	<b>Disposing</b> .....	<b>30</b>
<b>13</b>	<b>Service and support</b> .....	<b>31</b>
<b>14</b>	<b>Technical data</b> .....	<b>32</b>
	14.1 Dimensions .....	34
<b>15</b>	<b>Order guide</b> .....	<b>35</b>
<b>16</b>	<b>Declaration of Conformity</b> .....	<b>36</b>

## 1 About this document

### 1.1 Used symbols and signal words

Table 1.1: Warning symbols and signal words

	Symbol indicating dangers to persons
NOTE	Signal word for property damage Indicates dangers that may result in property damage if the measures for danger avoidance are not followed.
CAUTION	Signal word for minor injuries Indicates dangers that may result in minor injury if the measures for danger avoidance are not followed.
WARNING	Signal word for serious injury Indicates dangers that may result in severe or fatal injury if the measures for danger avoidance are not followed.
DANGER	Signal word for life-threatening danger Indicates dangers with which serious or fatal injury is imminent if the measures for danger avoidance are not followed.

Table 1.2: Other symbols



	Symbol for tips Text passages with this symbol provide you with further information.
	Symbol for action steps Text passages with this symbol instruct you to perform actions.

Table 1.3: Terms and abbreviations

AOPD	Active Optoelectronic Protective Device <b>Active Opto-electronic Protective Device</b>
EDM	<b>External Device Monitoring</b>
OSSD	<b>Output Signal Switching Device</b>
SSD	<b>Secondary Switching Device</b>
RES	Start/ <b>RE</b> start interlock
PFH <sub>0</sub>	Probability of a dangerous failure per hour <b>Probability of dangerous Failure per Hour</b>
MTTF <sub>d</sub>	Mean time to dangerous failure <b>(Mean Time To dangerous Failure)</b>
PL	<b>Performance Level</b>

### 1.2 Checklists

The checklists (see chapter 9 "Testing") serve as a reference for the machine manufacturer or supplier. They replace neither testing of the complete machine or system prior to the initial start-up nor their periodic testing by a competent person. The checklists contain minimum testing requirements. Depending on the application, other tests may be necessary.

## 2 Safety

Before using the safety sensor, a risk assessment must be performed according to valid standards (e.g. EN ISO 12100, EN ISO 13849-1, EN/IEC 61508, EN/IEC 62061). The result of the risk assessment determines the required safety level of the safety relay (see table 14.1). For mounting, operating and testing, this document as well as all applicable national and international standards, regulations, rules and directives must be observed. Relevant and supplied documents must be observed and handed to the affected personnel.



☞ Before working with the safety relay, completely read and understand the documents applicable to your task.

In particular, the following national and international legal regulations apply for the start-up, technical inspections and work with safety relays:



- Machinery directive 2006/42/EC
- Low voltage directive 2014/35/EU
- Electromagnetic compatibility 2014/30/EU
- Use of work equipment directive 2009/104/EC
- OSHA 1910 Subpart 0
- Safety regulations
- Accident-prevention regulations and safety rules
- Ordinance on Industrial Safety and Health and employment protection act
- Product safety law (Produktsicherheitsgesetz)

NOTE	
	For safety-related information you may also contact local authorities (e.g., industrial inspectorate, employer's liability insurance association, labor inspectorate, occupational safety and health authority).

### 2.1 Intended use and foreseeable misuse

 <b>DANGER</b>	
	<p><b>Electrically live systems pose a risk of electric shock!</b></p> <p>☞ During all conversions, maintenance work and inspections, make certain that the voltage supply is interrupted and protected against being restarted again.</p> <p>Only have work on the electrical system and electronics performed by a competent person.</p>

#### 2.1.1 Intended use

 <b>WARNING</b>	
	<p><b>A running machine may result in serious injury!</b></p> <p>☞ Make certain that the safety relay is correctly connected and that the protective function of the protective device is ensured.</p> <p>Make certain that, during all conversions, maintenance work and inspections, the system is securely shut down and protected against being restarted.</p>

Only if the safety relay is correctly connected and correctly started up is the protective function of the protective device ensured. To prevent misuse and resulting dangers, the following must be observed:

- These operating instructions are included in the documentation of the system on which the protective device is mounted and are available to the operating personnel at all times.
- The safety relay is used as a safety monitoring device in combination with one or more light beam safety devices for safeguarding danger zones or points of operation on machines and systems.
- The safety relay must only be used after it has been selected in accordance with the respectively applicable instructions and relevant standards, rules and regulations regarding labor protection and safety at work, and after it has been installed, connected, checked and commissioned by a **competent person**.
- The safety relay must only be connected and commissioned in accordance with its specifications (technical data, environmental conditions, etc.).
- The acknowledgment button for unlocking the start/restart interlock must be located outside of the danger zone.
- The entire danger zone must be visible from the installation site of the acknowledgment button.
- The safety relay must be selected so that its safety-related capability meets or exceeds the required Performance Level PL ascertained in the risk assessment (see table 14.1).
- The machine or system control must be electrically influenceable so that a switch command sent by the safety relay results in the immediate shutdown of the dangerous movement.
- The construction of the safety relay must not be altered. When manipulating the safety relay, the protective function is no longer guaranteed. Manipulating the safety relay also voids all warranty claims against the manufacturer of the safety relay.
- The safety relay must be tested regularly by a competent person (see chapter 9 "Testing").
- The safety relay must be exchanged after a maximum of 20 years. Repairs or the exchange of wear parts do not extend the mission time.

### 2.1.2 Foreseeable misuse

Any use other than that defined under the "Approved purpose" or which goes beyond that use is considered improper use.

Alone, the safety relay is not a complete protective device. It is not suitable for use in the following cases:

- in explosive or easily flammable atmospheres.
- on machines or systems with long stopping times.

## 2.2 Competent persons

Prerequisites for competent persons:

- They have a suitable technical education.
- They know the rules and regulations for labor protection, safety at work and safety technology and can assess the safety of the machine.
- They know the instructions for the safety relay and the machine.
- They have been instructed by the responsible person on the mounting and operation of the machine and of the safety relay.

## 2.3 Responsibility for safety

Manufacturer and operating company must ensure that the machine and implemented safety relay function properly and that all affected persons are adequately informed and trained.

The type and content of all imparted information must not lead to unsafe actions by users.

The manufacturer of the machine is responsible for:

- Safe machine construction.
- Safe implementation of the safety relay.
- Imparting all relevant information to the operating company.
- Adhering to all regulations and directives for the safe starting-up of the machine.

The operator of the machine is responsible for:

- Instructing the operating personnel.
- Maintaining the safe operation of the machine.
- Adhering to all regulations and directives for labor protection and safety at work.
- Regular testing by competent persons.

## 2.4 Exemption of liability

Leuze electronic GmbH + Co. KG is not liable in the following cases:

- Safety relay is not used as intended.
- Safety notices are not adhered to.
- Reasonably foreseeable misuse is not taken into account.
- Mounting and electrical connection are not properly performed.
- Proper function is not tested (see chapter 9 "Testing").
- Changes (e.g., constructional) are made to the safety relay.



### 3 Device description

The safety relays of the MSI-TRxB series are safety monitoring devices for electro-sensitive protective equipment (ESPE), type 2, on machines with risks of bodily injury (acc. to EN 61496-1:2013). As part of the electrical equipment, they enable machines or systems to achieve a safe state before persons can be endangered.

The safety relay is intended for installation on the DIN rail in the cabinet and is wired via the 16 terminals. All connection terminals are pluggable. The individual terminal blocks are mechanically coded to prevent swapping or skewed plug in. The safety relays are available with screw terminals or spring-cage terminals.

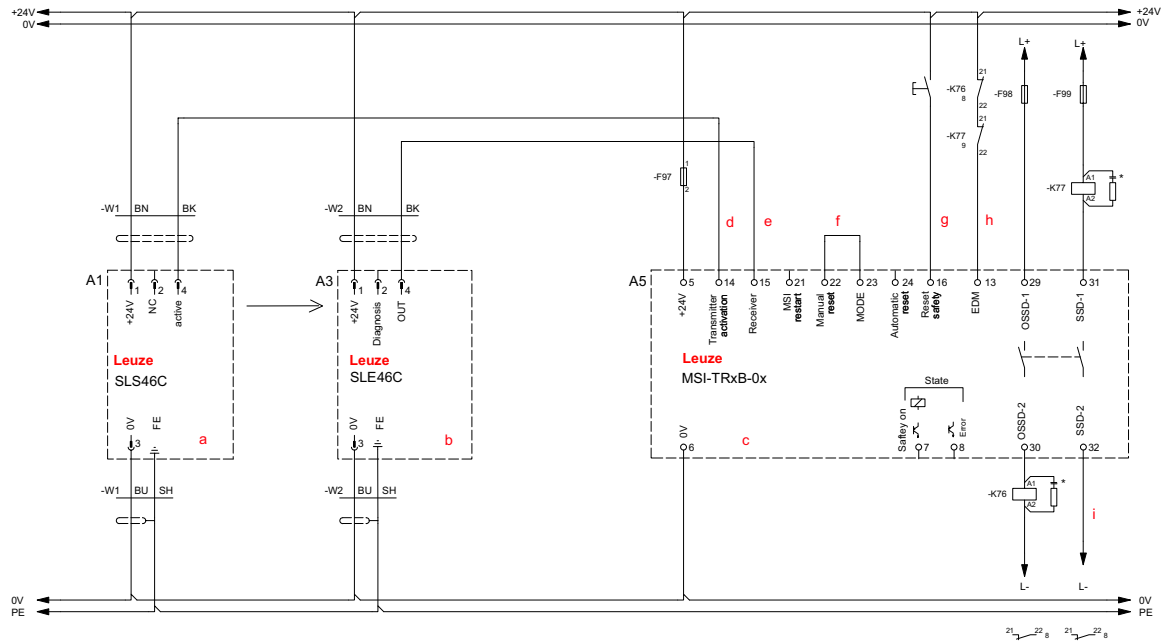

Figure 3.1: MSI-TR1B-01 with screw terminals



Figure 3.2: MSI-TR1B-02 with spring-cage terminals

The complete safety system consists of a safety relay and safety sensors connected to it.



- a Single light beam safety device transmitter (SLS 46C)
- b Single light beam safety device receiver (SLE 46C)
- c Safety relay for type 2 evaluation (MSI-TRxB)
- d Activation of the transmitter and testing of the single light beam safety device
- e Evaluation of the switching output of the single light beam safety device
- f Operating mode: restart interlock (RES) active
- g External reset button for manually resetting the protective device
- h Monitoring of external contactor contacts (EDM)
- i Potential-free normally open contacts with positive opening for the safe shutdown of, e.g., actuators

Figure 3.3: Example setup of the complete safety system with EDM and manual reset of the safety function (restart interlock).

### 3.1 Device overview

Device versions:

- MSI-TR1B: standard safety monitoring device for type-2 sensors.
- MSI-TR2B: safety monitoring device with extended filter time (switches only after a continuous interruption > 130 ms; ignores small parts).

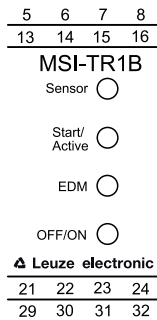

Figure 3.4: MSI-TR1B

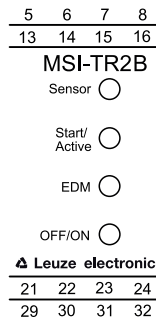
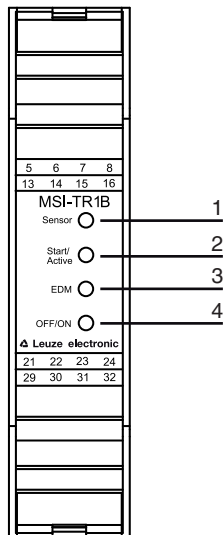

Figure 3.5: MSI-TR2B

### 3.2 Display elements

The display elements of the safety relay simplify start-up and fault analysis.



- 1 LED "Sensor"
- 2 LED "Start/Active"
- 3 LED "EDM"
- 4 LED "OFF/ON"

Figure 3.6: Display elements of the MSI-TRxB

Table 3.1: Meaning of the LEDs

LED	Color	Description
Sensor	Green	Light path free
Start/Active	Yellow	Start / restart interlock (RES) locked
EDM	Green	EDM selected
OFF/ON	Green	OSSD on
	Red	OSSD off

## 4 Functions

After switching on the safety relay via the start input, the functional capability of the connected safety sensors is cyclically monitored every two seconds.

The potential-free safety relay outputs are intended for shutting down a dangerous movement. Further integrated functions are listed in the following table.

Table 4.1: Functions of the different versions

Function	MSI-TR1B	MSI-TR2B
Periodic function test	•	•
Start/restart interlock (RES), selectable	•	•
Contactormonitoring (EDM), selectable	•	•
Indication output "Safety ON"	•	•
"Error" signal output	•	•

### 4.1 Start/restart interlock (RES)

The start/restart interlock prevents automatic start-up of the system (e.g. if the protective field is again clear or if an interruption in the voltage supply is restored). The operating personnel must make certain that no people are present in the danger zone before the system is manually re-enabled.

The default factory setting for this function is active.

### 4.2 Contactormonitoring (EDM)

The safety relay monitors the feedback circuits of connected contactors. The signal at the EDM input is compared to the state of the OSSDs. While the OSSDs are switched on, the feedback circuit is open (high-impedance); while the OSSDs are switched off, 24 V is applied to the EDM input.

The reaction at the EDM input with respect to the OSSDs is delayed by maximum 500 ms.

## 5 Applications

### 5.1 Access guarding

Safety relays are used together with single- or multiple light beam safety devices, e.g. as access guarding for danger zones. Because protective sensors only detect persons upon entry into the danger zone, and not whether a person is present in the danger zone, the safety relay only triggers the switch command upon entry of a person into a danger zone. Access guarding may therefore only be operated with activated start/restart interlock or additional safety measures must be taken.

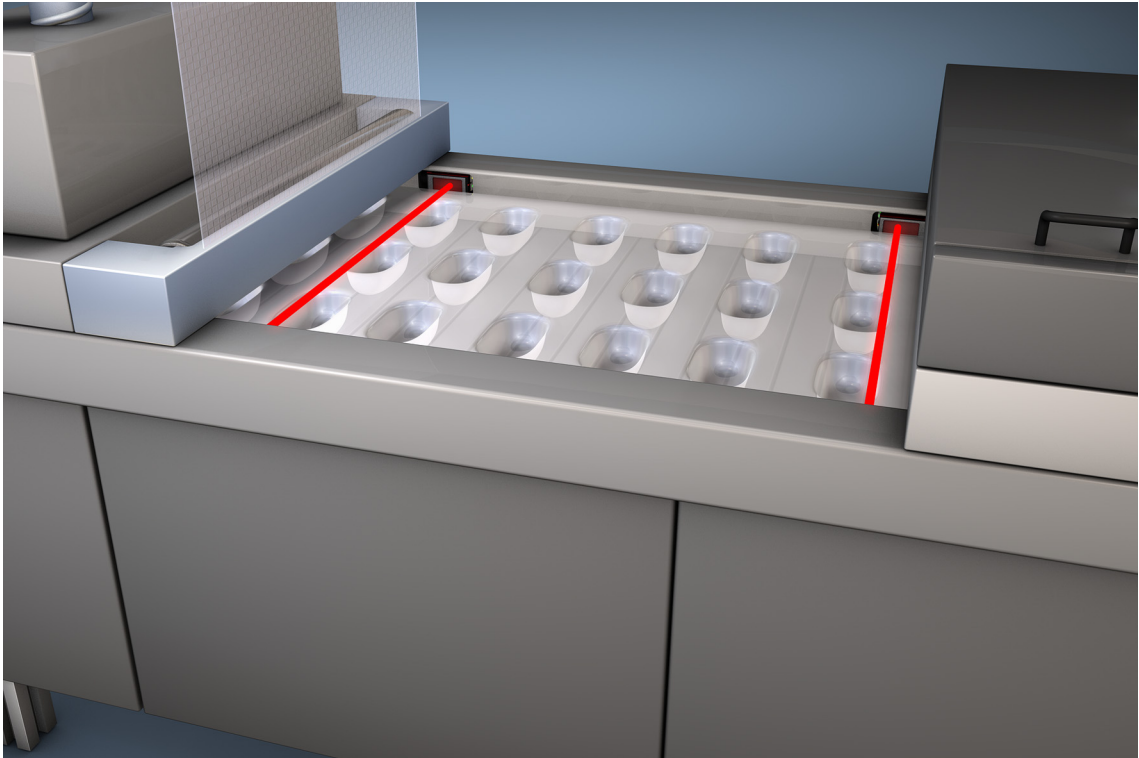

Figure 5.1: Intervention control on packaging machinery



Figure 5.2: Access guarding / intervention control on sawing machines

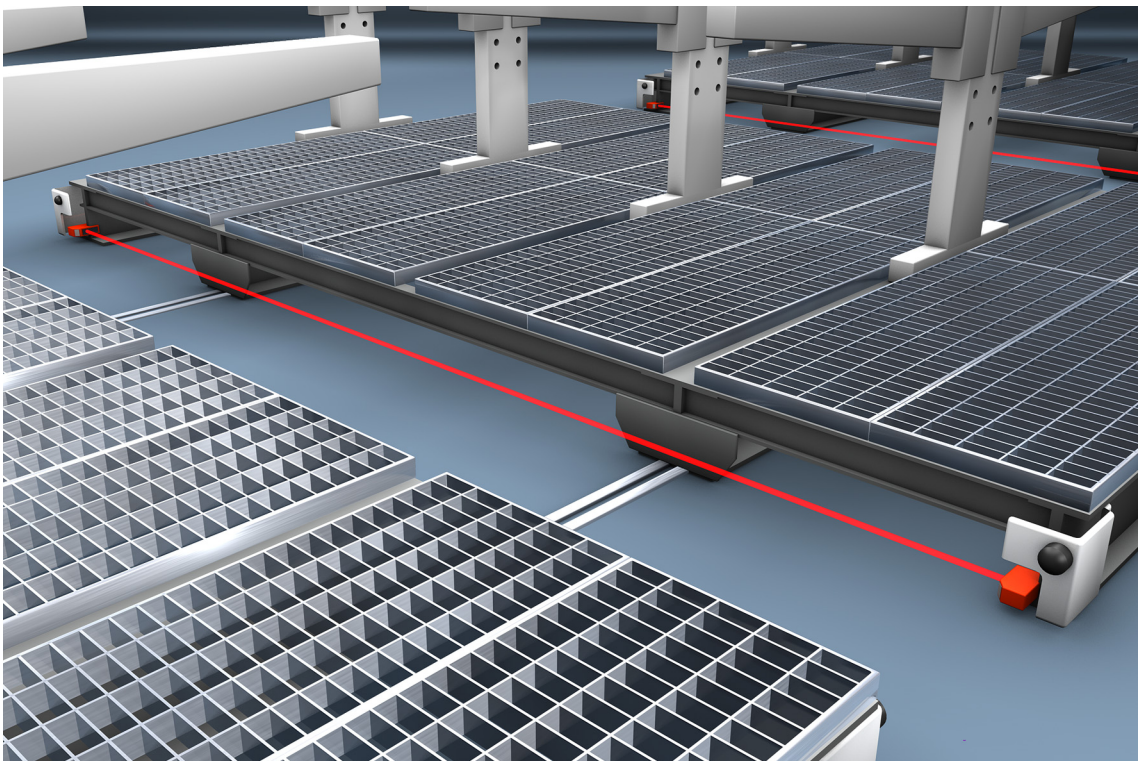



Figure 5.3: Foot-space protection on side-tracking shelves

## 6 Mounting

 <b>WARNING</b>	
	<p><b>Improper mounting may result in serious injury!</b></p> <p>The protective function of the safety relay is only ensured if appropriately and professionally mounted for the respective, intended area of application.</p> <p>↳ Only allow competent persons to install the safety relay.</p> <p>Observe the relevant standards, regulations and these instructions.</p>

The safety relay is intended for mounting on a DIN rail in the switch cabinet.

Prerequisites for mounting:

- Switch cabinet with appropriate degree of protection (at least IP54).
- Sufficient space on the DIN rail.
- Arrangement of the protective device acc. to EN ISO 13855 and EN 61496-2:2013 (see chapter 6.1 "Arrangement of the protective device").

↳ Snap the safety relay onto the DIN rail.

The safety relay can be connected to the safety sensors.

### 6.1 Arrangement of the protective device

Optical protective devices can only perform their protective function if they are mounted with adequate safety distance. When mounting, all delay times must be taken into account, e.g. the response times of the protective sensor and control elements as well as the stopping time of the machine.

The following standards specify calculation formulas:

- EN ISO 13855 "The positioning of protective devices in respect of approach speeds of parts of the human body": mounting situation and safety distances.
- EN 61496-2:2013, "Active optoelectronic protective devices": distance of the reflecting surfaces/ deflecting mirrors.

Table 6.1: Beam heights and distances

Number of beams/beam distance [mm]	Beam heights in accordance with EN ISO 13855 [mm]
2 / 500	400, 900
3 / 400	300, 700, 1100
4 / 300	300, 600, 900, 1200

#### 6.1.1 Calculating the safety distance

**General formula for calculating the safety distance S of an Optoelectronic Protective Device acc. to EN ISO 13855:**

$$S = K \cdot T + C$$

- S [mm] = Safety distance
- K [mm/s] = 1600 mm/s (approach speed for access guarding)
- T [s] = Total time of the delay
- C [mm] = 850 mm (default value for arm length)

↳ Calculate the safety distance S for access guarding using the formula acc. to ISO 13855 or EN 999:

$$S = 1600 \text{ mm} \cdot (t_a + t_i + t_m + t_t) + 850 \text{ mm}$$

- S [mm] = Safety distance
- t<sub>a</sub> [s] = Response time of the protective device
- t<sub>i</sub> [s] = Response time of the safety relay
- t<sub>m</sub> [s] = Machine stopping time
- t<sub>t</sub> [s] = Test interval time of safety relay

Table 6.2: Values for t<sub>i max</sub>

Device	t <sub>i max</sub> [ms]
MSI-TR1B	80
MSI-TR2B	150

NOTE	
	If longer stopping times are determined during regular inspections, an appropriate additional time must be added to t <sub>m</sub> .

6.1.2 Multi-axis arrangement

Figure 6.1: With multi-axis installation, the light beams must run parallel to the reference plane (e.g. floor) and must be aligned mutually parallel.

The beam directions are to be set oppositely in each case (See Figure 6.2:). Otherwise, the light beams could cause mutual interference and disturb reliable function.

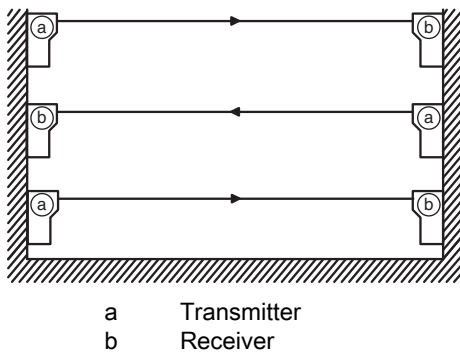



Figure 6.2: Multi-axis arrangement

6.1.3 Minimum distance to reflective surfaces

⚠ WARNING	
	<p><b>Failure to maintain minimum distances to reflective surfaces may result in serious injury!</b></p> <p>Reflective surfaces can indirectly deflect the transmitter beams to the receiver. In this case, interruption of the protective field is not detected.</p> <p>Make certain that all reflective surfaces are the necessary minimum distance away from the protective field.</p>



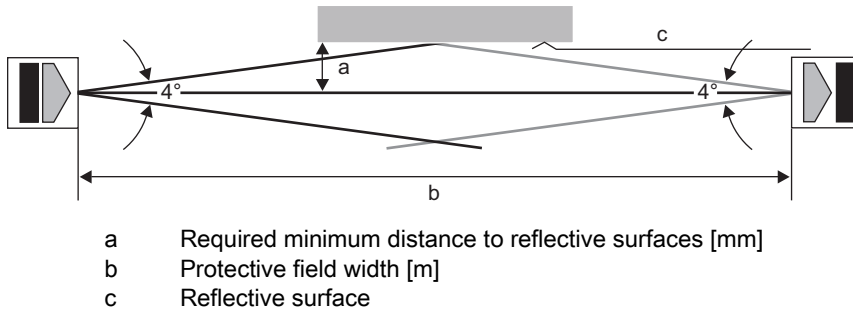

Figure 6.3: Minimum distance to reflective surfaces depending on protective field width

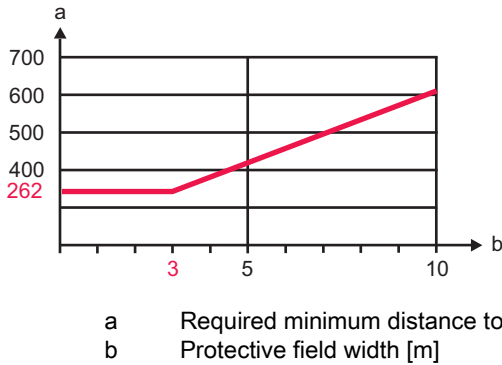

Figure 6.4: Minimum distance to reflective surfaces as a function of the protective field width up to 10 m

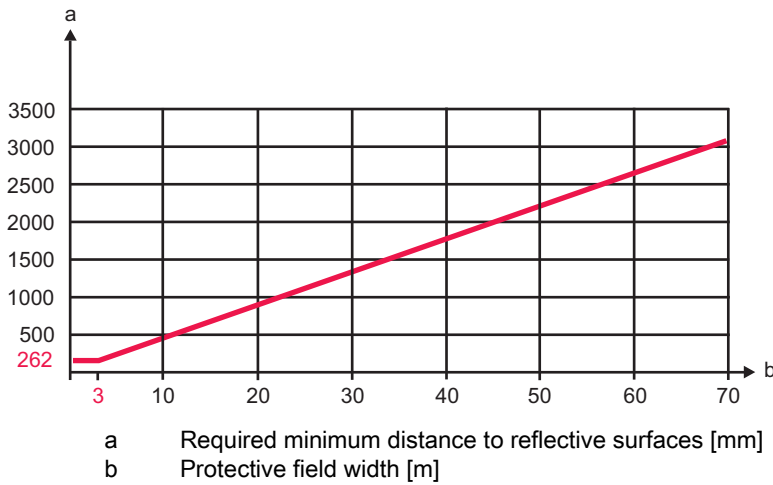

Figure 6.5: Minimum distance to reflective surfaces as a function of the protective field width up to 70 m

↪ Calculate the minimum distance to reflective surfaces depending on the installation situation and according to the following formula:

Table 6.3: Calculating the minimum distance

Distance (b) transmitter-receiver	Calculation of the minimum distance (a) to reflective surfaces
$b \leq 3 \text{ m}$	$a \text{ [mm]} = 262$
$b > 3 \text{ m}$	$a \text{ [mm]} = \tan(5^\circ) \cdot 1000 \cdot b \text{ [m]} = 43.66 \cdot b \text{ [m]}$

**Deflecting mirrors**

When using deflecting mirrors, the following must be observed:

- Range loss per deflecting mirror of approx. 15 %.
- Deflecting mirrors must not be soiled.
- Environmental conditions (vapors or dust-laden air considerably limit the range).
- Arrange the deflecting mirror so that the optical axis is aligned with the center of the mirror (See Figure 6.6:).

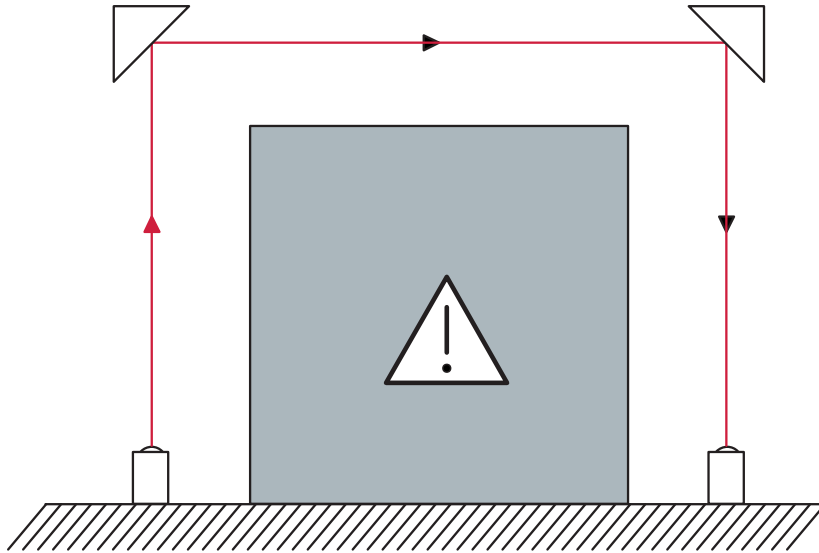

Figure 6.6: Arrangement of the deflecting mirrors

**6.1.4 Checklist – mounting the protective sensor**

**Interval:** once prior to establishing the electrical connection

**Tester:** competent person

Table 6.4: Checklist – mounting the protective sensor

Items on the check list	Yes	No
Do the beam heights satisfy the requirements acc. to EN ISO 13855 (see table 6.1)?		
Is the safety distance to the point of operation maintained (see chapter 6.1.1 "Calculating the safety distance")?		
Is the minimum distance to reflective surfaces maintained (see chapter 6.1.3 "Minimum distance to reflective surfaces")?		
Is it ensured that protective sensors cannot mutually influence one another?		
Can the point of operation or the danger zone only be accessed through the protective field?		
Is it ensured that the protective field cannot be circumvented?		
Do the transmitter and receiver connections point in the same direction?		
Is the protective sensor mounted acc. to the corresponding instructions provided by the manufacturer?		

Items on the check list	Yes	No
Is the protective sensor accessible for testing and replacing?		
Is it ensured that the reset button cannot be activated from within the danger zone?		
Can the entire danger zone be n from the installation site of the reset button?		

## 7 Electrical connection

⚠ DANGER	
	<p><b>Risk of death by electric shock!</b></p> <p>Depending on external wiring, dangerous voltages may be present at the switching outputs. During all work at the electrical system or electronics, make certain that each voltage supply has been interrupted and protected against being restarted.</p>

The following must be observed for the current supply of the safety relay:

- Supply voltage 24 V DC ±20 %.
- Safe mains separation acc. to EN/IEC 60742 possible.
- A corresponding power supply unit handles interruptions of the supply voltage up to 10 ms in duration acc. to EN/IEC 61496-1.

⚠ WARNING	
	<p><b>Improper electrical connection may result in serious injury!</b></p> <ul style="list-style-type: none"> <li>↳ Only allow competent persons to perform the electrical connection.</li> <li>↳ Make certain that supply and signal lines are laid separately from power lines.</li> <li>↳ Use appropriate spark extinction for contactors in the cabinet.</li> </ul> <p>Observe the installation notices and operating instructions of the products that are to be connected via the safety relay (drive motors, brakes, etc.).</p>

The following conditions apply for the electrical connection:

- The safety relay is to be integrated in the control acc. to EN ISO 13849-1.
- No safety-relevant signals are switched via the message outputs.
- There are always two switching contacts integrated in the system switch-off circuit.
- Relay switching contacts are fused/protected externally according to their specifications (see table 14.3).

### Connecting the signal lines

For reliable and touch-safe contacts, isolate the connection ends as follows:

- Screw terminals: 7 mm
- Spring-cage terminals: 8 mm

### 7.1 Terminal assignments

⚠ WARNING	
	<p><b>Selecting the wrong functions may result in serious accidents!</b></p> <ul style="list-style-type: none"> <li>↳ Always connect protective sensors to an external safety relay and activate the restart interlock.</li> <li>↳ For access guarding, make certain that the restart interlock cannot be unlocked from within the danger zone but that the danger zone can be viewed from the acknowledgment button (reset button).</li> </ul> <p>Select the functions so that the safety relay is used as intended (see chapter 2.1 "Intended use and foreseeable misuse").</p>

Connected to the safety relay are 16 numbered terminals to which the cables for the various functions are connected.

Table 7.1: Terminal assignments

Terminal	Name	Category	Function
5	+24 V	Voltage supply	-
6	0 V	Voltage supply	-
7	Safety ON	Output	Signal output (LOW - protective field interrupted; HIGH - protective field free)
8	Error	Output	Signal output (LOW - no error; HIGH - error)
13	EDM	Input	For the integration of the normally closed contacts of external contactors
14	Transmitter activation	Output	Activation of the transmitter / testing of the protective sensor
15	Receiver	Input	Connection of the switching output of the protective sensor
16	Reset safety	Input	Depending on the operating mode (see table 7.3): <ul style="list-style-type: none"> <li>• Connection of external reset buttons for resetting the safety function if restart interlock is active</li> <li>• Terminal 16 on 24 V if automatic restart is active</li> </ul>
21	MSI restart	Input	A 24 V signal triggers a restart of the MSI processor.
22	Manual reset	Input	Configuration of the start-up behavior by inserting the corresponding bridges (see table 7.3)
23	Mode	Output	
24	Auto reset	Input	
29 / 30	OSSD 1/2	Safety output	Potential-free normally open contacts for the safe shutdown of, e.g., actuators
31 / 32	SSD 1/2	Secondary switching device	

## 7.2 Configuration of the EDM and RES operating modes

### EDM configuration

Table 7.2: EDM configuration

Function	Terminals
EDM selected	Connect terminal 13 (EDM) to feedback circuit
EDM not selected	Bridge between terminals 13 and 14

↳ Trigger an "MSI restart" (24 V on terminal 21 or briefly interrupt supply voltage).

The new settings are accepted.

Configuration RES

Table 7.3: Configuration RES

Function	Terminals
Operation with start/restart interlock (factory setting)	Bridge between terminals 22 and 23
Automatic restart	Bridge between terminals 23 and 24, 24 V at terminal 16

↳ Trigger an "MSI restart" (24 V on terminal 21 or briefly interrupt supply voltage).  
 The new settings are accepted.

7.3 Circuit diagram examples

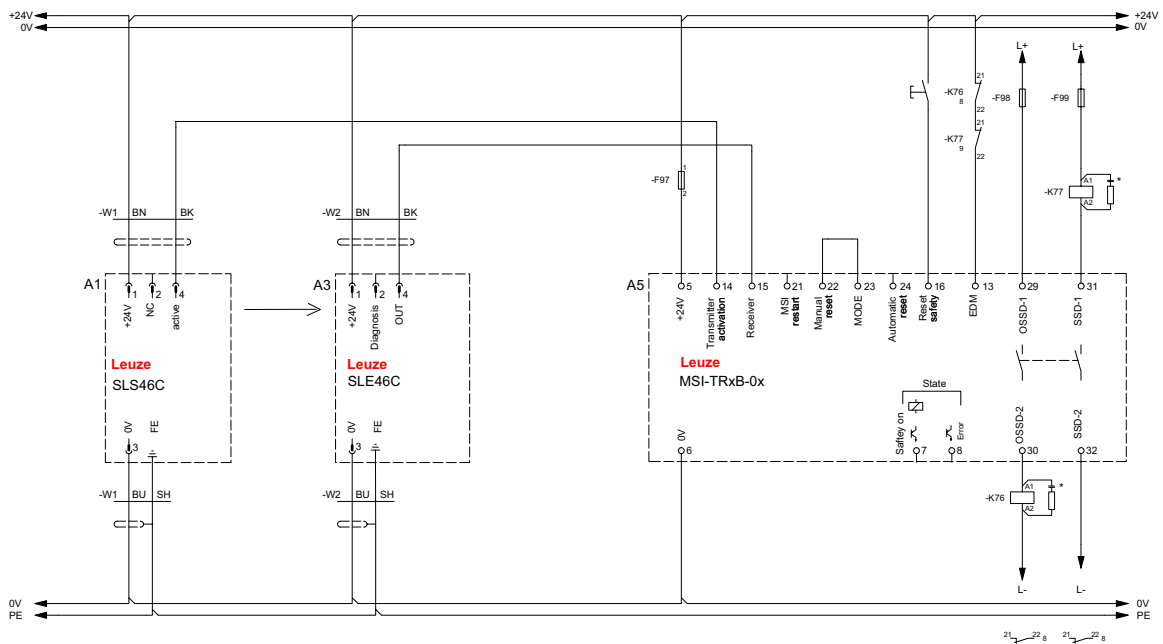

Figure 7.1: MSI-TRxB-xx safety relay with type 2 SLS 46C single light beam safety device, start/restart interlock (RES) and external contactor monitoring (EDM).

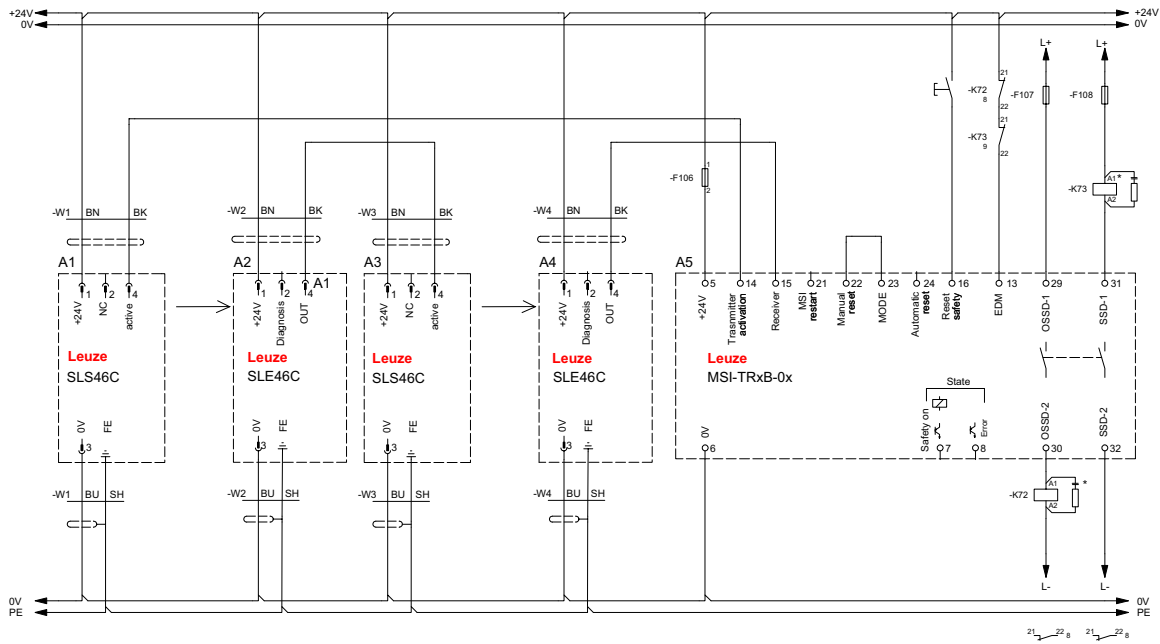

Figure 7.2: MSI-TRxB-xx safety relay with 2x SLS 46C type 2 single light beam safety devices in series, start/restart interlock (RES) and external contactor monitoring (EDM).

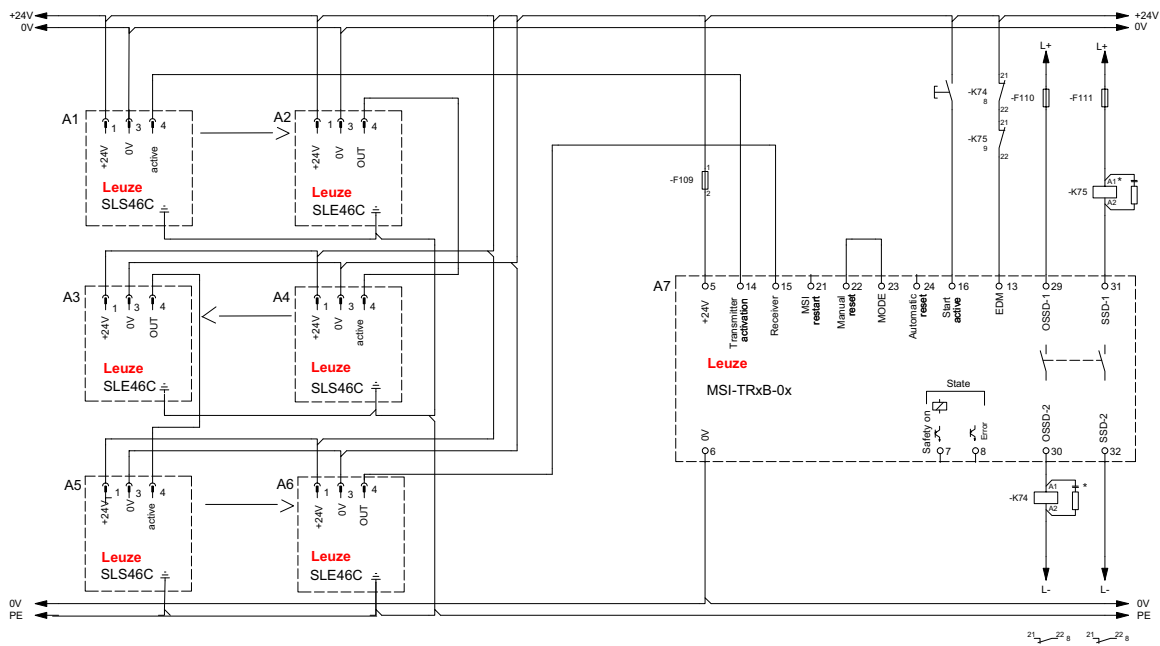



Figure 7.3: MSI-TRxB-xx safety relay with 3x SLS 46C type 2 single light beam safety devices in series, start/restart interlock (RES) and external contactor monitoring (EDM).

## 8 Starting up the device

 <b>WARNING</b>	
	<p><b>Improper use of the safety relay may result in serious injury!</b></p> <p>↪ Make certain that the entire device and the integration of the optoelectronic protective device was inspected by competent and instructed persons.</p> <p>Make certain that a dangerous process can only be started while the safety sensor is switched on.</p>

Prerequisites:

- Protective sensors and safety relay were mounted and connected in accordance with the respective instructions.
- Operating personnel were instructed on proper use.
- Dangerous process was switched off and the system has been protected against being restarted again.

↪ During start-up, test the function of the safety relay (see chapter 9 "Testing").

### 8.1 Switching on

Requirements for the supply voltage (power supply unit):

- Safe mains separation is ensured (acc. to EN/IEC 60742).
- Changes and interruptions of the supply voltage are handled (acc. to EN/IEC 61496-1).
- The start/restart interlock function is connected and activated.



↪ Switch on the current supply.

↪ Check whether the "ON/OFF" LED on the safety relay lights up.

The safety relay is ready for use.

### 8.2 Unlocking start/restart interlock (RES)

The start/restart interlock can be unlocked with an external reset button (see figure 3.3). In this way, the responsible person can restore normal operation of the system following process interruptions (triggering of the protective function, failure of the voltage supply) .

 <b>WARNING</b>	
	<p><b>Premature unlocking of the start/restart interlock may result in serious injury!</b></p> <p>If the start/restart interlock is unlocked, the system can start up automatically.</p> <p>Before unlocking the start/restart interlock, make certain that no people are in the danger zone.</p>

The red and yellow LEDs illuminate as long as the restart is disabled.

↪ Make certain that the active protective field is clear.

↪ If the active protective field is not clear, select a different procedure.



↪ Make certain that there are no people in the danger zone.

↪ Press the reset button and release it again (after 0.06 ... 5 s).

The safety relay switches back to the "ON" state.



## 9 Testing

 <b>WARNING</b>	
	<p><b>A running machine may result in serious injury!</b> Make certain that, during all conversions, maintenance work and inspections, the system is securely shut down and protected against being restarted.</p>



The safety relays must be exchanged after a maximum of 20 years.

- ↪ Always exchange the entire safety relay.
- ↪ For the tests, observe nationally applicable regulations.
- ↪ Document all tests in a comprehensible manner.

### 9.1 Before the initial start-up and following modifications

Acc. to IEC/TS 62046 and international regulations (e.g. EU directive 2009/104/EC), tests are to be performed by competent persons in the following situations:

- Prior to the initial start-up
- Following modifications to the machine
- After longer machine downtime
- After retrofitting or reconfiguring the safety device (safety relay and/or protective sensor)

 <b>WARNING</b>	
	<p><b>Unpredictable machine behavior during initial start-up may result in serious injury!</b> Make certain that there are no people in the danger zone.</p>

- ↪ Test the effectiveness of the shutdown function in all operating modes of the machine acc. to the corresponding checklist (see chapter 9.1.1 "Checklist – initial start-up").
- ↪ Document all tests in a comprehensible manner and include the configuration of the safety relay along with the data for the safety and minimum distances in the documentation.
- ↪ Before they begin work, train the operating personnel on their respective tasks. The training is the responsibility of the operating company.
- ↪ Check whether the safety relay was correctly selected acc. to the locally applicable regulations and directives.
- ↪ Check whether the safety relay is operated acc. to the specified environmental conditions (see chapter 14 "Technical data").
- ↪ Make certain that the safety relay is protected against overcurrent.
- ↪ Perform a visual inspection for damage and test the electrical function (see chapter 9.2 "To be performed periodically by a competent person").

Minimum requirements for the power supply unit:

- Safe mains separation.
- Power-failure bridging for at least 10 ms.

Not until proper function of the optoelectronic safety device and the safety relay is ascertained may they be integrated in the control circuit of the system.

#### 9.1.1 Checklist – initial start-up

**Interval:** once, prior to the initial start-up and following modification

**Tester:** competent person

Table 9.1: Checklist – initial start-up

Items on the check list	Yes	No
Were all safety directives and standards relevant to this machine type observed?		
Does the declaration of conformity of the machine include a listing of these documents?		
Does the safety relay satisfy the safety-related capability (PL, SIL, category) as required by the risk assessment?		
Circuit diagram: Are the safety-related switching outputs (OSSDs) integrated in the downstream machine control acc. to the required safety category?		
Are the switching elements (e.g. contactors) with positive-guided contacts that are controlled by the safety relay monitored by an external device monitoring circuit (EDM)?		
Does the electrical wiring match the circuit diagrams?		
Have the required protective measures against electrical shock been effectively implemented?		
Has the maximum stopping time of the machine been remeasured and recorded in the machine documents?		
Is the required safety distance (protective field to the next point of operation) maintained?		
Are all points of operation of the machine accessible only through the protective field? Are all additional protective devices (e.g. safety guards) correctly mounted and protected against tampering?		
Is the command device for triggering the start/restart interlock of the safety relay or the machine mounted in accordance with specifications?		
Are safety relay, connecting cable, plug, protection caps and command devices undamaged and free of any signs of manipulation?		
Has the effectiveness of the protective function been ensured for all operating modes of the machine by means of a function test?		
Is the reset button for resetting the safety relay mounted outside of the danger zone in accordance with specifications in such a way that it cannot be reached from within the danger zone? Can the entire danger zone be seen from the place at which the start/restart button is installed?		
Does the interruption of any given beam cause the dangerous movement to stop?		
When the AOPD is separated from its supply voltage, does the dangerous movement stop, and, after the supply voltage has been restored, is it necessary to actuate the reset button to reset the machine?		
Is the safety relay/protective sensor effective during the entire dangerous movement of the machine?		
Are the notices for daily testing of the safety sensor legible to the operating personnel and are they located in a highly visible location?		
Is the muting indicator visibly mounted on the entry/exit path?		

📁 Store this checklist with the machine documents.

## 9.2 To be performed periodically by a competent person

The reliable interaction of safety sensor, safety relay and machine must be periodically tested in order to detect changes to the machine or impermissible tampering with the safety sensor. Testing intervals are determined by nationally applicable regulations (recommendation acc. to IEC/TS 62046: 6 months).

- ↪ Have all tests performed by competent persons.
- ↪ Observe the nationally applicable regulations and the time periods specified therein.

### 9.3 To be performed daily by the operating personnel

The function of the safety relay must be checked daily or at change of shifts, and at each change of machine operating mode as specified in the corresponding checklist (see chapter 9.3.1 "Check list – daily or at change of shift") so that damages or unauthorized manipulations can be detected.

⚠ WARNING	
	<p><b>Unpredictable machine behavior during the test may result in serious injury!</b> Make certain that there are no people in the danger zone.</p>

⚠ WARNING	
	<p><b>Faults during the daily inspection may result in serious injury!</b> If you answer one of the items on the check list (see table 9.2) with "no", the machine must no longer be operated. Have the entire machine inspected by a competent person (see chapter 9.1 "Before the initial start-up and following modifications").</p>

- ↪ Stop the dangerous state.
- ↪ Check safety relay, transmitter, receiver and, if applicable, deflecting mirrors for damage or manipulation.
- ↪ Interrupt the light beam of the protective sensor from a position outside the danger zone and ensure that the machine cannot be started with an interrupted light beam.
- ↪ Start the machine.
- ↪ Ensure that the dangerous state is stopped as soon as a light beam is interrupted.

#### 9.3.1 Check list – daily or at change of shift

**Interval:** daily or at shift change

**Tester:** authorized operating personnel or instructed person

Table 9.2: Check list – daily or at change of shift

Items on the check list	Yes	No
Are safety relay, protective sensor, connecting cables, plugs and command devices undamaged and free of any signs of manipulation?		
Are all points of operation at the machine accessible only through one or more protective fields of protective sensors?		
Are all additional protective devices mounted correctly (e.g., safety guard)?		
Does the start/restart interlock prevent the automatic start-up of the machine after the protective sensor/safety relay has been switched on or activated?		
↪ Interrupt a light beam of the protective sensor with a test object during operation. Is the dangerous movement shut down immediately?		

## 10 Maintenance

The safety relay is maintenance-free.

## 11 Troubleshooting

### 11.1 What to do in case of failure?

After switching on the safety relay, display elements (LEDs, see chapter 3.2 "Display elements") assist in checking the proper function and troubleshooting.

In case of error, you can determine the error from the LED displays. With the error message you can determine the cause of the error and initiate measures to rectify it.

NOTE	
	<p><b>If the safety relay indicates a fault, it may be defective.</b></p> <ul style="list-style-type: none"> <li>↳ Switch off the machine and leave it switched off.</li> <li>↳ Analyze and eliminate the cause of the fault (see chapter 11.2 "Operating indicators of the LEDs").</li> </ul> <p>If you are unable to rectify the fault, contact the Leuze branch responsible for you or call the Leuze hotline.</p>

### 11.2 Operating indicators of the LEDs

LED	State	Cause	Measure
EDM	Flashing	Fault in the EDM wiring	Check the wiring of the connected contactors.
Sensor	Flashing	Fault in the wiring of the protective sensors	Check the wiring of the protective sensors.
Sensor, EDM and start	Simultaneous flashing	Internal device error	In the event of an unsuccessful restart, contact customer service.

↳ If it was possible to rectify a detected error, perform an "MSI restart" (24 V on terminal 21) or briefly disconnect the MSI-TRxB from the voltage supply.

## 12 Disposing

↳ For disposal observe the applicable national regulations regarding electronic components.

## 13 Service and support

24-hour on-call service at:  
+49 7021 573-0

Service hotline:  
+49 7021 573-123

E-mail:  
[service.protect@leuze.de](mailto:service.protect@leuze.de)

Return address for repairs:  
Service center  
Leuze electronic GmbH + Co. KG  
In der Braike 1  
D-73277 Owen / Germany

## 14 Technical data

Table 14.1: Safety-relevant technical data

Type in accordance with IEC/EN 61496	Type 2
SILCL in accordance with IEC/EN 62061	SILCL 1
Performance Level (PL) in accordance with EN ISO 13849-1: 2015	Up to PL c
Category in accordance with EN ISO 13849-1:2015	Category 2
Probability of a dangerous failure per hour (PFH <sub>d</sub> )	$8.8 \times 10^{-8}$
Mean time to dangerous failure (MTTF <sub>d</sub> )	78 years
Mission time (T <sub>M</sub> )	20 years

Table 14.2: Electrical data, degree of protection, environment

Operating voltage U <sub>b</sub>	+24 V DC ±20 % (SELV)
Residual ripple	<15 %
Current consumption	Approx. 200 mA
Response time	<20 ms
Sensor response time on test request	0.5 ... 60 ms
Filter time MSI-TR2B	130 ms
Start-up delay	Approx. 2 s
Protection class	III
Degree of protection	IP40 (only suitable for use in operating rooms/cabinets with minimum protection rating of IP54)
Ambient temperature, operation	-30 ... +60 °C
Ambient temperature, storage	-40 ... +70 °C
Relative humidity (non-condensing)	0 ... 95 %
Dimensions	see chapter 14.1
Weight	Approx. 200 g
Permissible wire gauge screw terminals	0.2 ... 2.5 mm <sup>2</sup> (AWG 24-12)
Permissible wire gauge spring-cage terminals	0.2 ... 1.5 mm <sup>2</sup> (AWG 24-16)
Tightening torque for connection terminals	0.5 ... 0.6 Nm
Max. cable lengths (reset circuit)	250 m
<b>Example for max. cable length, for:</b>	
Conductor cross section	1.5 mm <sup>2</sup>
Capacity	150 nF/km



Resistance	11.7 Ohm/km
Max. cable lengths (reset circuit)	250 m
Max. cable lengths (input circuit)	250 m

Table 14.3: Inputs/outputs

Transmitter activation (terminal 14)	PNP (high active)
Receiver input (terminal 15)	Input current approx. 5 mA
Reset safety input (terminal 16)	Input current approx. 5 mA
MSI restart (terminal 21)	Input current approx. 5 mA
Contactors monitoring (EDM) (terminal 13)	Input current approx. 5 mA
Safety ON signal output (terminal 7)	PNP transistor output, 100 mA, short-circuit and polarity reversal protection
Message output error (terminal 8)	PNP transistor output, 100 mA, short-circuit and polarity reversal protection
Safety output (terminals 29/30 and 31/32)	Potential-free make contacts, max. switching voltage 250 V AC, max. current load 2 A
Fuse	External with max. 3.15 A MT
Overvoltage category	2 for rating voltage 300 V AC acc. to VDE 0110 part 1
Switching voltage	High $\geq 15V$ ; low $< 5V$

14.1 Dimensions

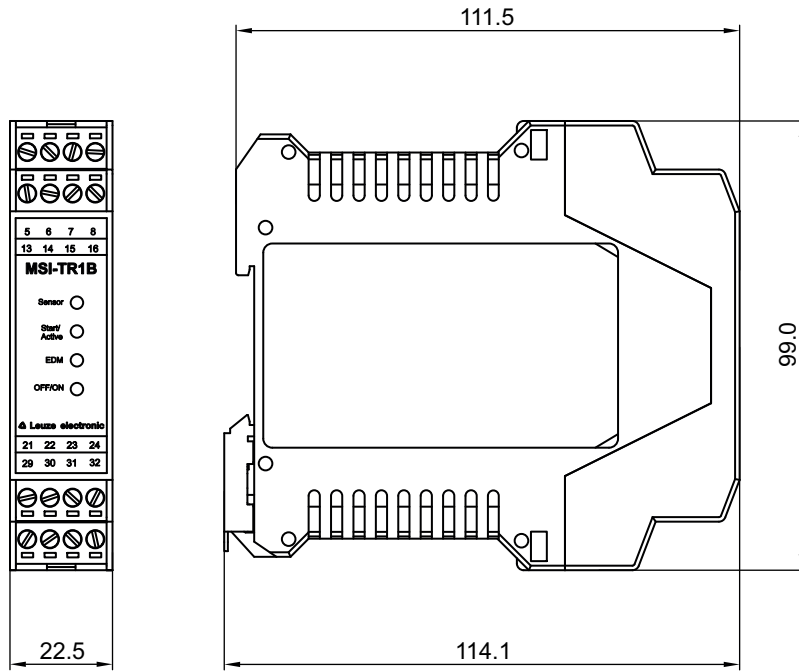

Figure 14.1: Dimensions MSI-TRxB-01

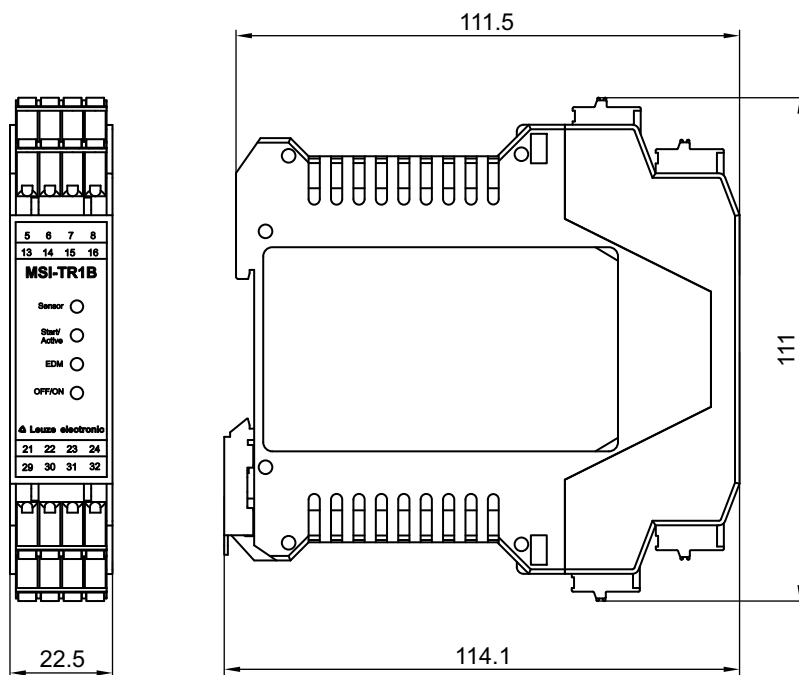

Figure 14.2: Dimensions MSI-TRxB-02

## 15 Order guide

Table 15.1: Safety relay MSI-TRxB

Part no.	Article	Description
547958	MSI-TR1B-01	for periodic testing of type-2 sensors, screw terminals
547959	MSI-TR1B-02	for periodic testing of type-2 sensors, spring-cage terminals
547960	MSI-TR2B-01	for periodic testing of type-2 sensors with filter time 130 ms, screw terminals
547961	MSI-TR2B-02	for periodic testing of type-2 sensors with filter time 130 ms, spring-cage terminals

