

**PRKL 3B Laser-retro-reflective photoel. sensors with polariz. filter for bottles**

en 04-2016/01 50115107-01

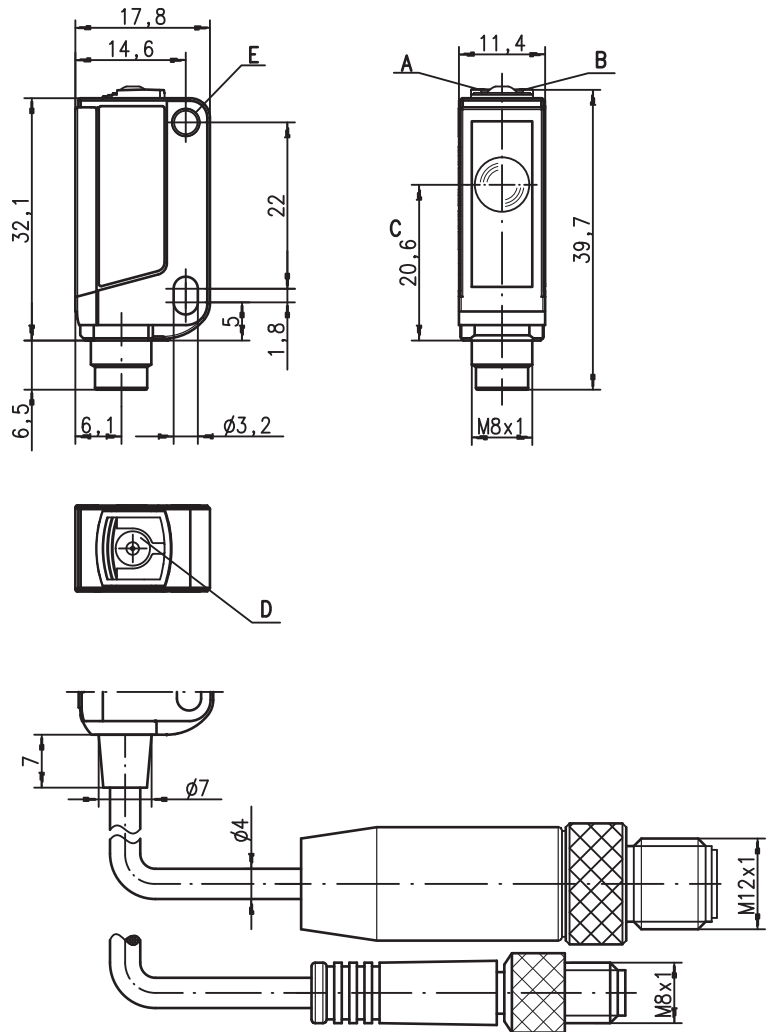

**Dimensioned drawing**



- A Green indicator diode
- B Yellow indicator diode
- C Optical axis
- D Teach button
- E Mounting sleeve

2 kHz

0...500 mm

10 - 30 V  
DC

- Polarized, laser retro-reflective photoelectric sensor, autocollimation optics
- Trigger sensor for highly transparent bottles (PET and glass)
- Small and compact construction with robust plastic housing, protection class IP 67 for industrial application
- Push-pull output with light/dark switching via teach-in button
- High switching frequency for detection of fast events and small parts
- Laser safety class 1
- Easy adjustment via lockable teach button or teach input

**Electrical connection**

Plug connection, 4-pin (with/without cable)

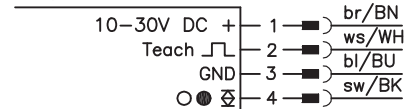

Plug connector, 3-pin

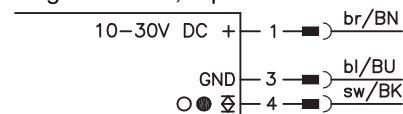

**Accessories:**

(available separately)

- Mounting systems (BT 3...)
- Cable with M8 or M12 connector (K-D ...)
- Reflectors
- Reflective tape 6

We reserve the right to make changes • DS\_PRKL3B642\_en\_50115107\_01.fm

## Specifications

### Optical data

Typ. operating range limit (tape 6) <sup>1)</sup>	0 ... 500mm
Operating range <sup>2) 3)</sup>	see tables
Light beam characteristic	collimated, ≤ 3mrad
Light spot diameter	approx. 2mm at optical outlet
Light source <sup>4)</sup>	laser (pulsed)
Laser class	1 in accordance with IEC 60825-1:2007
Wavelength	655nm (visible red light, polarized)
Max. output power	≤ 0.29mW
Pulse duration	5.5µs

### Timing

Switching frequency	2000Hz
Response time	0.25ms
Delay before start-up	≤ 300ms

### Electrical data

Operating voltage $U_B$ <sup>5)</sup>	10 ... 30VDC (incl. residual ripple)
Residual ripple	≤ 15% of $U_B$
Open-circuit current	≤ 15mA
Switching output	.../6.42 1 push-pull switching output pin 4: PNP light switching, NPN dark switching pin 2: teach input light/dark reversible
Function characteristics	≥ ( $U_B - 2V$ ) / ≤ 2V
Signal voltage high/low	max. 100mA
Output current	setting via teach-in
Operating range	

### Indicators

Green LED	ready
Yellow LED	light path free
Yellow LED, flashing	light path free, no performance reserve <sup>6)</sup>

### Mechanical data

Housing <sup>7)</sup>	plastic (PC-ABS); 1 attachment sleeve, nickel-plated steel
Optics cover	plastic (PMMA)
Weight	with connector: 10g with 200mm cable and connector: 20g with 2m cable: 50g
Connection type	2m cable (cross section 4x0.20mm <sup>2</sup> ), connector M8 metal, 0.2m cable with connector M8 or M12

### Environmental data

Ambient temp. (operation/storage)	-10°C ... +55°C <sup>8)</sup> / -30°C ... +70°C
Protective circuit <sup>9)</sup>	2, 3
VDE safety class	III
Protection class	IP 67
Standards applied	IEC 60947-5-2
Certifications	UL 508, CSA C22.2 No.14-13 <sup>5) 10)</sup>

### Options

#### Teach-in input/activation input

Transmitter active/not active	≥ 8V/≤ 2V
Activation/disable delay	≤ 1ms
Input resistance	30kΩ

- 1) Typ. operating range limit: max. attainable range without performance reserve
- 2) Operating range: recommended range with performance reserve
- 3) At a reflector distance of < 50mm, highly transparent bottle are no longer detected
- 4) Average life expectancy 50,000h at an ambient temperature of 25°C
- 5) For UL applications: for use in class 2 circuits according to NEC only
- 6) Display "no performance reserve" as yellow flashing LED is only available in standard teach setting
- 7) Patent Pending Publ. No. US 7,476,848 B2
- 8) Without mounting max. +50°C, with screw mounting on metal part up to +55°C permissible
- 9) 2=polarity reversal protection, 3=short circuit protection for all transistor outputs
- 10) These proximity switches shall be used with UL Listed Cable assemblies rated 30V, 0.5A min, in the field installation, or equivalent (categories: CYJV/CYJV7 or PVVA/PVVA7)

## Remarks

### Operate in accordance with intended use!

- ⚠ This product is not a safety sensor and is not intended as personnel protection.
- ⚠ The product may only be put into operation by competent persons.
- ⚠ Only use the product in accordance with the intended use.

### UL REQUIREMENTS

Enclosure Type Rating: Type 1

#### For Use in NFPA 79 Applications only.

Adapters providing field wiring means are available from the manufacturer. Refer to manufacturers information.

**CAUTION** – the use of controls or adjustments or performance of procedures other than those specified herein may result in hazardous radiation exposure.

**ATTENTION !** Si d'autres dispositifs d'alignement que ceux préconisés ici sont utilisés ou s'il est procédé autrement qu'indiqué, cela peut entraîner une exposition à des rayonnements et un danger pour les personnes.

## Tables

Reflectors			Operating range <sup>3)</sup>
1	TK	series 53	0 ... 0.4m
2	REF	6-S-20x40	0 ... 0.4m
3	Tape 6	25x25	0 ... 0.4m

1	0	0.4	0.5
2	0	0.4	0.5
3	0	0.4	0.5

- Operating range [m]
- Typ. operating range limit [m]

- If necessary, reflectors not listed here can be used. Please call our application service hotline for information.

## Remarks

- The devices may only be operated with the devices listed in the table.

### Mounting system:



- ① = BT 3 (part no. 50060511)
- ②+③ = BT 3.1 <sup>1)</sup> (part no. 50105585)
- ①+②+③ = BT 3B (part no. 50105546)

1) Packaging unit: PU = 10 pcs.

## PRKL 3B Laser-retro-reflective photoel. sensors with polariz. filter for bottles

### Order guide

Selection table		Order code →				
Equipment ↓		PRKL 3B/6.42-S8 Part No. 50115117	PRKL 3B/6.4-S8.3 Part No. 50120275	PRKL 3B/6.42, 200-S8 Part No. 50115118	PRKL 3B/6.42, 200-S12 Part No. 50115119	PRKL 3B/6.42 Part No. 50115116
Switching output	1 x push-pull switching output	●	●	●	●	●
Switching function	light/dark switching configurable	●	●	●	●	●
Connection	M8 connector, metal, 4-pin	●				
	M8 connector, metal, 3-pin <sup>1)</sup>		●			
	cable 200 mm with M8 connector, 4-pin			●		
	cable 200 mm with M12 connector, 4-pin				●	
	2000 mm cable, 4-wire					●
Configuration	teach-in via button (lockable) and teach input <sup>1)</sup>	●	● <sup>1)</sup>	●	●	●
Indicators	green LED: ready	●	●	●	●	●
	yellow LED: switching output	●	●	●	●	●

1) Teach input not present with 3-pin connector

### Remarks

Adapter plate: BT 3.2 (part no. 50103844) for alternate mounting on 25.4 mm hole spacing (Omron E3Z, Sick W100...)



### Laser safety notices – Laser class 1



#### ATTENTION, LASER RADIATION – LASER CLASS 1

The device satisfies the requirements of IEC 60825-1:2007 (EN 60825-1:2007) safety regulations for a product in **laser class 1** as well as the U.S. 21 CFR 1040.10 regulations with deviations corresponding to "Laser Notice No. 50" from June 24th, 2007.

↳ Adhere to the applicable legal and local regulations regarding protection from laser beams.

↳ The device must not be tampered with and must not be changed in any way.

There are no user-serviceable parts inside the device.

Repairs must only be performed by Leuze electronic GmbH + Co. KG.

### Sensor adjustment (teach) via teach button



- **Prior to teaching:**  
**Clear the light path to the reflector!**  
The device setting is stored in a fail-safe way. A reconfiguration following voltage interruption or switch-off is thus not required.

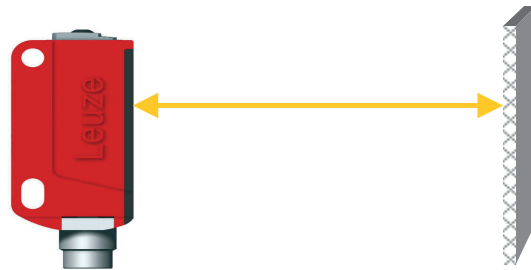

#### **Teach for 11% sensor sensitivity (highly transparent bottles and foils with thickness > 20µm)**

- Press teach button until both LEDs flash **simultaneously**.
- Release teach button.
- Ready.



After the teaching, the sensor switches when about 11% of the light beam are covered by the object.

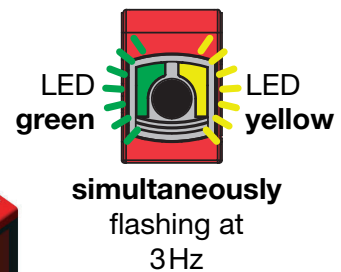
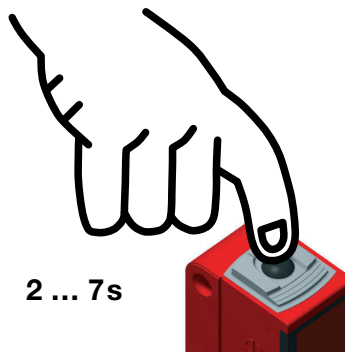

#### **Teach for 18% sensor sensitivity (standard bottles)**

- Press teach button until both LEDs flash **alternatingly**.
- Release teach button.
- Ready.



After the teaching, the sensor switches when about 18% of the light beam are covered by the object.

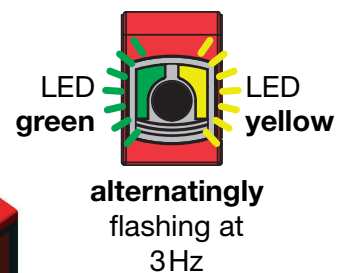
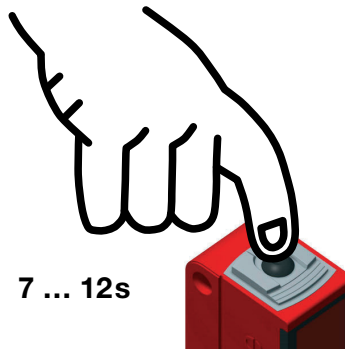

**PRKL 3B Laser-retro-reflective photoel. sensors with polariz. filter for bottles**

***Teaching for maximum operating range (factory setting at delivery)***

- Prior to teaching:  
**Cover** the light path to the reflector!
- Press teach button until both LEDs flash **simultaneously**.
- Release teach button.
- Ready.

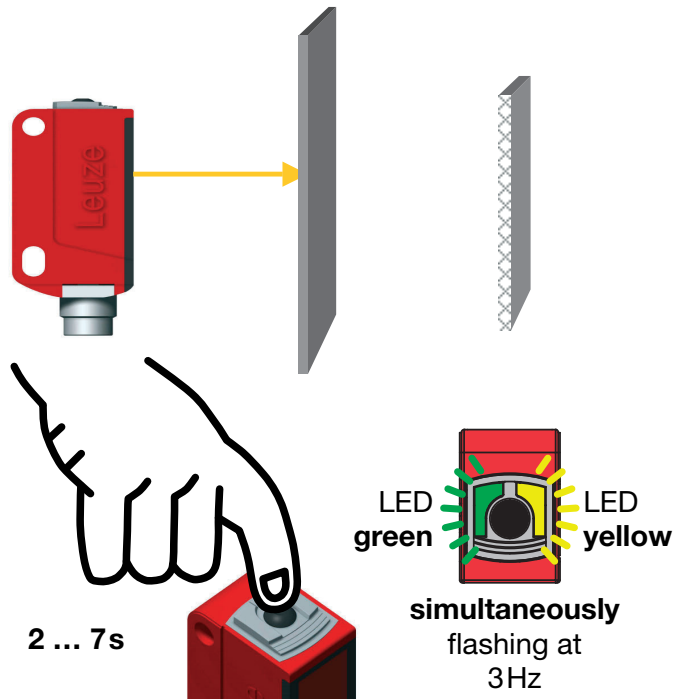

***Adjusting the switching behavior of the switching output – light/dark switching***

- Press teach button until the green LED flashes. The yellow LED displays the current setting of the switching output:  
ON = output switches on light  
OFF = output switches on dark
- Continue to press the teach button in order to change the switching behavior.
- Release teach button.
- Ready.

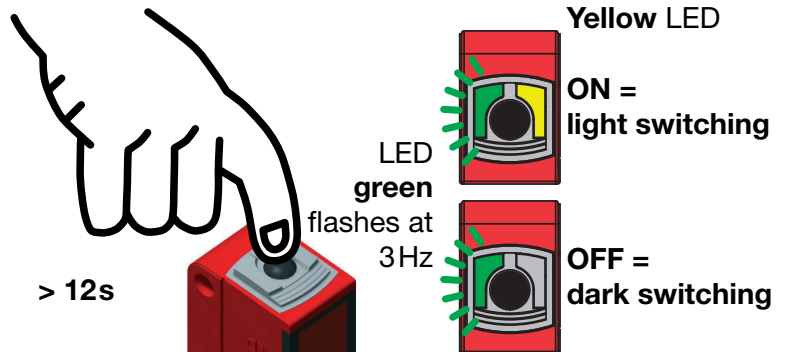

**Locking the teach button via the teach input**



A **static HIGH signal** ( $\geq 4\text{ms}$ ) at the teach input locks the teach button on the device if required, such that no manual operation is possible (e.g., protection from erroneous operation or manipulation).

If the teach input is not connected or if there is a static low signal, the button is unlocked and can be operated freely.

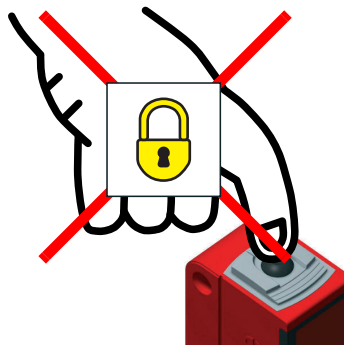

## Sensor adjustment (teach) via teach input



The following description applies to PNP switching logic!

$$U_{\text{Teach low}} \leq 2V$$

$$U_{\text{Teach high}} \geq (U_B - 2V)$$

**Prior to teaching: Clear the light path to the reflector!**

The device setting is stored in a fail-safe way. A reconfiguration following voltage interruption or switch-off is thus not required.

### Teach for 11% sensor sensitivity (highly transparent bottles and foils with thickness > 20µm)

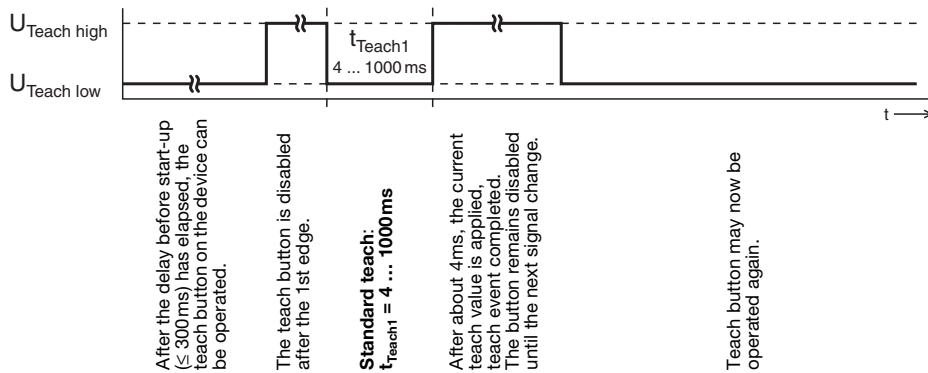

### Quick teach for 11% sensor sensitivity (highly transparent bottles and foils with thickness > 20µm)

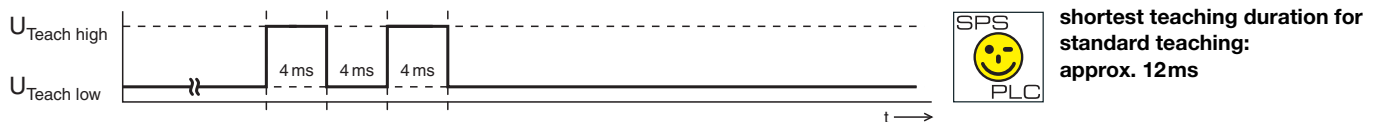

After teaching for 11% sensor sensitivity, the sensor switches for objects with a minimum size of 1 mm.

**PRKL 3B Laser-retro-reflective photoel. sensors with polariz. filter for bottles**

***Teach for 18% sensor sensitivity (standard bottles)***

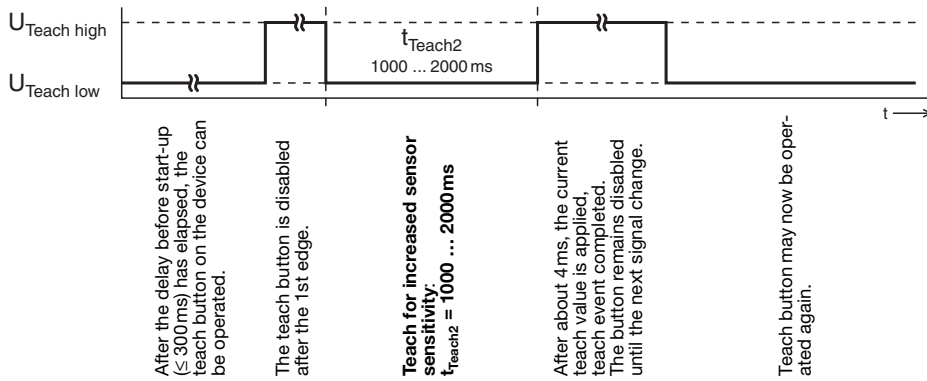

After teaching for 18% sensor sensitivity, the sensor switches for objects with a minimum size of 0.1 mm ... 0.2mm.

***Adjusting the switching behavior of the switching output – light/dark switching***

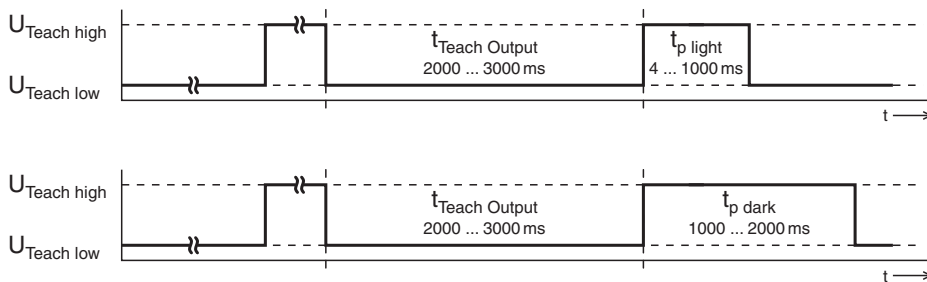

After the delay before start-up (≤ 300ms) has elapsed, the teach button on the device can be operated.

The teach button is disabled after the 1st edge.

**Setting the switching behavior of the switching output:**  
 $t_{\text{Teach Output}} = 2000 \dots 3000\text{ms}$

**Switching output switches on light:**  
 $t_{\text{p light}} = 4 \dots 1000\text{ms}$

**Switching output switches on dark:**  
 $t_{\text{p dark}} = 1000 \dots 2000\text{ms}$   
 The button remains disabled until the next signal change.

