

Technical data sheet

Safety light curtain receiver

Part no.: 68003328
MLC530R30-2850



For illustration purposes only

Contents

- Technical data
- Dimensioned drawings
- Electrical connection
- Circuit diagrams
- Operation and display
- Suitable transmitters
- Part number code
- Notes
- Accessories



Technical data

Basic data

Series	MLC 500
Device type	Receiver
Contains	2x BT-NC sliding block
Application	Hand protection

Functions

Function package	Extended
Functions	<p>Combination of floating/fixed blanking, can be changed to "fixed blanking" during operation</p> <p>Configuration by means of wiring</p> <p>Fixed blanking with 1-beam tolerance</p> <p>Fixed blanking without tolerance</p> <p>Fixed blanking without tolerance, can be activated/deactivated during operation</p> <p>Floating blanking, can be changed to "fixed blanking" during operation</p> <p>Integration of "contact-based safety circuit"</p> <p>Integration of "electronic safety-related switching outputs"</p> <p>MaxiScan</p> <p>Partial muting</p> <p>Reduced resolution, can be changed to "fixed blanking" during operation</p> <p>Start/restart interlock (RES)</p> <p>Timing controlled 2-sensor muting</p> <p>Transmission channel changeover</p>

Characteristic parameters

Type	4, IEC/EN IEC 61496
SIL	3, IEC 61508
SIL	3, IEC/EN IEC 62061
Performance Level (PL)	e, EN ISO 13849-1
PFH _D	7.73E-09 per hour
Mission time T _M	20 years, EN ISO 13849-1
Category	4, EN ISO 13849

Protective field data

Resolution	30 mm
Protective field height	2,850 mm

Optical data

Synchronization	Optical between transmitter and receiver
-----------------	--

Electrical data

Protective circuit	<p>Overvoltage protection</p> <p>Short circuit protected</p>
--------------------	--

Performance data

Supply voltage U _B	24 V, DC, -20 ... 20 %
Current consumption, max.	150 mA
Fuse	2 A semi time-lag

Inputs

Number of digital switching inputs	3 Piece(s)
------------------------------------	------------

Switching inputs

Type	Digital switching input
Switching voltage high, min.	18 V
Switching voltage low, max.	2.5 V
Switching voltage, type.	22.5 V
Voltage type	DC

Outputs

Number of safety-related switching outputs (OSSDs)	2 Piece(s)
--	------------

Safety-related switching outputs

Type	Safety-related switching output OSSD
Switching voltage high, min.	18 V
Switching voltage low, max.	2.5 V
Switching voltage, type.	22.5 V
Voltage type	DC
Current load, max.	380 mA
Load inductivity	2,000 µH
Load capacity	0.3 µF
Residual current, max.	0.2 mA
Residual current, type.	0.002 mA
Voltage drop	1.5 V

Safety-related switching output 1

Assignment	Connection 1, pin 5
Switching element	Transistor, PNP

Safety-related switching output 2

Assignment	Connection 1, pin 6
Switching element	Transistor, PNP

Time behavior

Response time	25 ms
Restart delay time	100 ms

Connection

Number of connections	1 Piece(s)
-----------------------	------------

Connection 1

Function	Machine interface
Type of connection	Connector
Thread size	M12
Material	Metal
No. of pins	8 -pin

Cable properties

Permissible conductor cross section, type.	0.25 mm ²
Length of connection cable, max.	100 m
Permissible cable resistance to load, max.	200 Ω

Technical data

Mechanical data

Dimension (W x H x L)	29 mm x 2,916 mm x 35.4 mm
Housing material	Metal
Metal housing	Aluminum
Lens cover material	Plastic / PMMA
Material of end caps	Diecast zinc
Net weight	3,000 g
Housing color	Yellow, RAL 1021
Type of fastening	Groove mounting Mounting brackets Mounting on Device Column Swivel mount

Operation and display

Type of display	7-segment display LED
Number of LEDs	3 Piece(s)

Environmental data

Ambient temperature, operation	-30 ... 55 °C
Ambient temperature, storage	-30 ... 70 °C
Relative humidity (non-condensing)	0 ... 95 %

Certifications

Degree of protection	IP 65
Protection class	III
Approvals	c TÜV NRTL US c UL US KCs TÜV Süd
Vibration resistance	50 m/s ²
Shock resistance	100 m/s ²
US patents	US 6,418,546 B

Classification

Customs tariff number	85365019
ECLASS 5.1.4	27272704
ECLASS 8.0	27272704
ECLASS 9.0	27272704
ECLASS 10.0	27272704
ECLASS 11.0	27272704
ECLASS 12.0	27272704
ECLASS 13.0	27272704
ECLASS 14.0	27272704
ECLASS 15.0	27272704
ECLASS 16.0	27272704
ETIM 5.0	EC002549
ETIM 6.0	EC002549
ETIM 7.0	EC002549
ETIM 8.0	EC002549
ETIM 9.0	EC002549
ETIM 10.0	EC002549
UNSPSC 26.08	46171620

Dimensioned drawings

All dimensions in millimeters

Calculation of the effective protective field height $H_{PFE} = H_{PFN} + B + C$

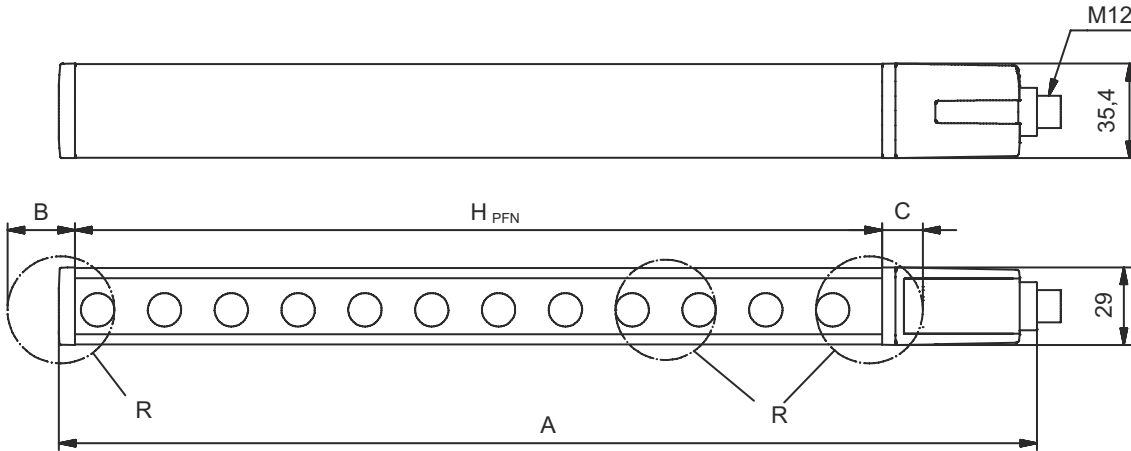

H_{PFE} Effective protective field height = 2878 mm

H_{PFN} Nominal protective field height = 2850 mm

A Total height = 2916 mm

B 19 mm

C 9 mm

R Effective protective field height H_{PFE} goes beyond the dimensions of the optics area to the outer borders of the circles labeled with R.

Electrical connection

Connection 1

Function	Machine interface
Type of connection	Connector
Thread size	M12
Type	Male
Material	Metal
No. of pins	8 -pin
Encoding	A-coded
Connector housing	FE/SHIELD

Pin	Pin assignment	Conductor color
1	IO1	White
2	VIN1	Brown
3	IN3	Green
4	IN4	Yellow
5	OSSD1	Gray
6	OSSD2	Pink
7	VIN2	Blue
8	IN8	Red

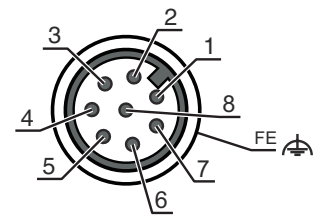

Circuit diagrams

Connection diagram receiver



- VIN1 = +24 V, VIN2 = 0 V: transmission channel C1
- VIN1 = 0 V, VIN2 = +24 V: transmission channel C2

Operating mode 1: circuit diagram example of linkage with position switch for monitoring for the presence of machine parts with fixed blanking



- 1 Linked safety sensor, e.g. safety door switch
- 2 Key switch for teaching ("teach key switch")

Circuit diagrams

Operating mode 2: circuit diagram example of linkage of electronic safety-related switching outputs for the combined monitoring of access points and areas



Operating mode 3: circuit diagram example of a linked, contact-based position switch for monitoring of the blanked object and a changeover switch for switching between function groups FG1 and FG2

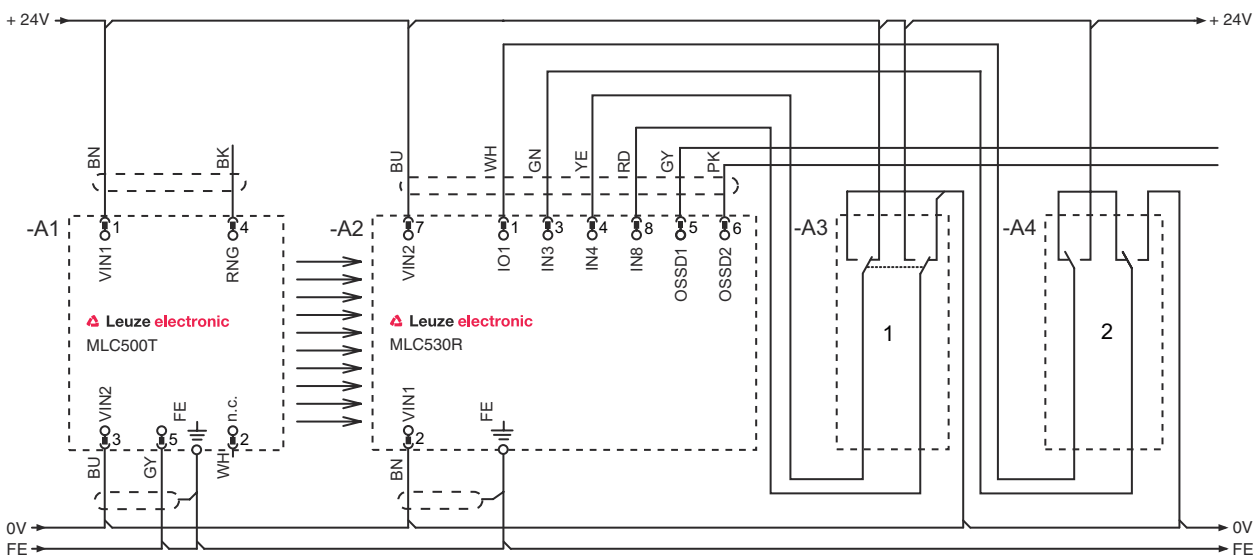

- 1 Changeover key switch for switching between function groups FG1 and FG2
- 2 Key switch for teaching blanking areas

Circuit diagrams

Operating mode 4: circuit diagram example for timing controlled 2-sensor muting



Operation and display

LED	Display	Meaning
1	Off	Device switched off
	Red, continuous light	OSSD off
	Red, flashing, 1 Hz	External error
	Red, flashing, 10 Hz	Internal error
	Green, flashing, 1 Hz	OSSD on, weak signal
	Green, continuous light	OSSD on
2	Off	RES deactivated or RES activated and enabled or RES blocked and protective field interrupted
	Yellow, continuous light	RES activated and blocked but ready to be unlocked - protective field free and linked sensor is enabled if applicable
	Yellow, flashing	Upstream safety circuit opened
	Yellow, flashing (1x or 2x)	Changeover of the upstream safety circuit
3	Off	No special function (blinking, muting, etc.) active
	Blue, continuous light	Protective field parameter (blinking) correctly taught
	Blue, flashing, 1 Hz	Muting active
	Blue, short flashing	Teaching of protective field parameters or muting restart required or muting override active
	Blue, flashing, 10 Hz	Error during teaching of protective field parameters

Suitable transmitters

Part no.	Designation	Article	Description
68000328	MLC500T30-2850	Safety light curtain transmitter	Resolution: 30 mm Protective field height: 2,850 mm Operating range: 0 ... 10 m Connection: Connector, M12, Metal, 5 -pin

Part number code

Part designation: MLCxyy-za-hhhhei-ooo

MLC	Safety light curtain
x	Series 3: MLC 300 5: MLC 500
yy	Function classes 00: transmitter 01: transmitter (AIDA) 02: transmitter with test input 10: basic receiver - automatic restart 11: basic receiver - automatic restart (AIDA) 20: standard receiver - EDM/RES selectable 30: Extended receiver blanking/muting or gating 35: Extended receiver – Gating
z	Device type T: transmitter R: receiver
a	Resolution 14: 14 mm 20: 20 mm 30: 30 mm 40: 40 mm 90: 90 mm
hhhh	Protective field height 150 ... 3000: from 150 mm to 3000 mm
e	Host/Guest (optional) H: Host MG: Middle Guest G: Guest
i	Interface (optional) /A: AS-i
ooo	Option /V: high Vibration-proof EX2: explosion protection (zones 2 + 22) SPG: Smart Process Gating SPG RR: Smart Process Gating – Reduced resolution

Note



A list with all available device types can be found on the Leuze website at www.leuze.com.

Notes

 **Observe intended use!**



- The product may only be put into operation by competent persons.
- Only use the product in accordance with its intended use.

Accessories

Connection technology - Connection cables

	Part no.	Designation	Article	Description
	50135128	KD S-M12-8A-P1-050	Connection cable	Application: Oil and lubricant resistant Connection 1: Connector, M12, Axial, Female, A-coded, 8 -pin Connector, LED: No Connection 2: Open end Shielded: Yes Cable length: 5,000 mm Sheathing material: PUR

Mounting technology - Swivel mounts

	Part no.	Designation	Article	Description
	429393	BT-2HF	Mounting bracket set	Contains: 2x BT-HF swivel mount, 1 cylinder for mounting on the light curtain Fastening, at system: Through-hole mounting Mounting bracket, at device: Clampable Type of mounting device: Turning, 360° Material: Metal, Plastic

Services

	Part no.	Designation	Article	Description
	S981050	CS40-I-140	Safety inspection	Details: Checking of a safety light barrier application in accordance with current standards and guidelines. Inclusion of the device and machine data in a database, production of a test log per application. Conditions: It must be possible to stop the machine, support provided by customer's employees and access to the machine for Leuze employees must be ensured.
	S981046	CS40-S-140	Start-up support	Details: For safety devices including stopping time measurement and initial inspection. Conditions: Devices and connection cables are already mounted, price not including travel costs and, if applicable, accommodation expenses.

Note



A list with all available accessories can be found on the Leuze website in the Download tab of the article detailed page.