

**LSR 46B**

**Throughbeam photoelectric sensor with alignment indicator**

en 03-2011/01 50109623-01



**60m**



- Throughbeam photoelectric sensor with visible red light
- Fast alignment through *brightVision*®
- Indicator for fast, precise alignment
- Push-pull switching outputs
- Sensitivity adjustment
- Warning output - for increased availability
- Further options for adapting to the respective application

**Dimensioned drawing**

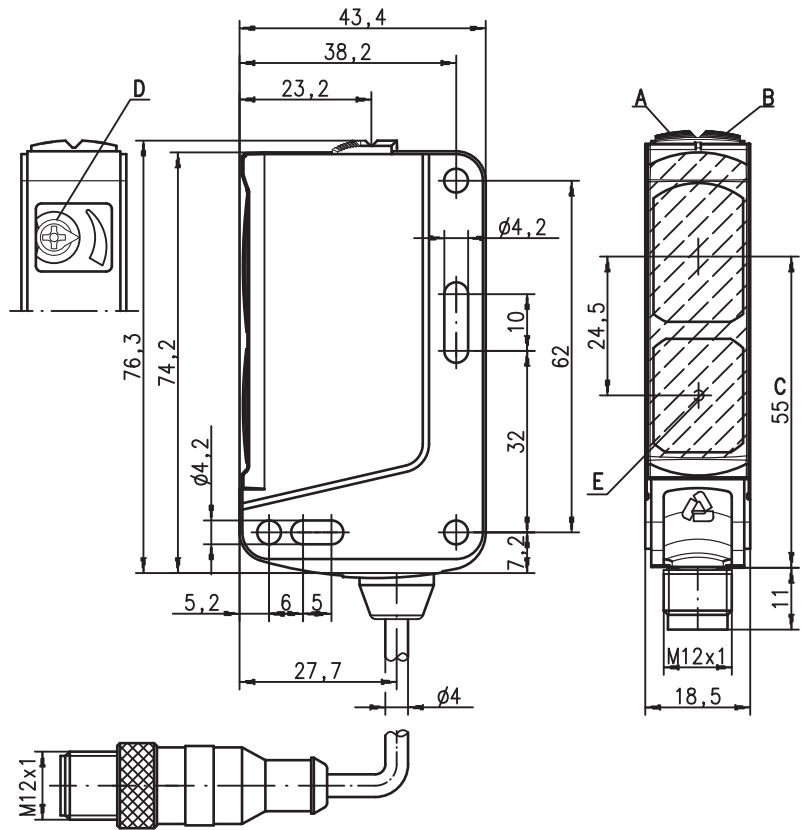

- A** Green indicator diode
- B** Yellow indicator diode
- C** Optical axis
- D** Optional sensitivity adjustment (only at receiver)
- E** Indicator diode for alignment control

**Electrical connection**

Transmitter, connector 4-pin

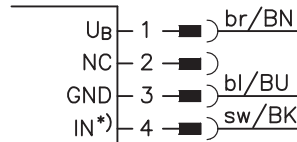

Receiver, connector 4-pin

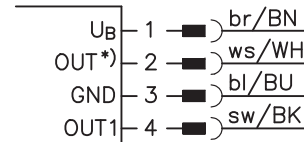

Selection pin 2/4

*)	OUT	IN
	OUT 2	active
	warn	
	NC	

Transmitter, cable

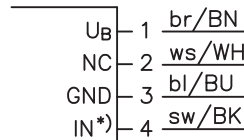

Receiver, cable

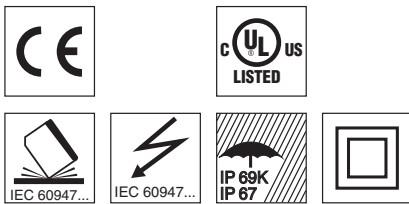
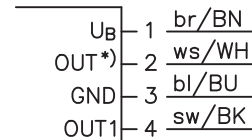

**Accessories:**

(available separately)

- Mounting systems (BT 46, BT 46.1, BT 46.1.5, BT 46.2)
- M12 connectors (KD ...)
- Ready-made cables (K-D ...)
- Alignment aid (SAT 5)

We reserve the right to make changes • DS\_LSR\_46B\_en.fm

## Specifications

### Optical data

Typ. operating range limit <sup>1)</sup>	60m
Operating range <sup>2)</sup>	50m
Light source <sup>3)</sup>	LED (modulated light)
Wavelength	620nm (visible red light, polarized)

### Timing

Switching frequency	500Hz
Response time	1 ms
Delay before start-up	≤ 300ms

### Electrical data

#### With transistor switching outputs

Operating voltage $U_B$ <sup>4)</sup>	10 ... 30VDC (incl. residual ripple)
Residual ripple	≤ 15% of $U_B$
Open-circuit current	≤ 20mA
Switching output <sup>5)</sup>	2 push-pull switching outputs
	pin 2: PNP dark switching, NPN light switching
	pin 4: PNP light switching, NPN dark switching
	1 warning output pin 2: PNP
	pin 4: PNP light switching
	≥ ( $U_B - 2V$ ) / ≤ 2V
	max. 100mA

Signal voltage high/low	LSR .../66
Output current	LSR .../66.1
	ILSR .../4
	ILSR .../4.8

### Indicators

Green LED	ready
Yellow LED	light path free
Yellow LED, flashing	light path free, no performance reserve

### Mechanical data

Housing	plastic (PC-ABS)
Optics cover	plastic (PMMA)
Weight (with connector/with cable and conn.)	50g/65g
Connection type	M12 connector, or cable with M12 connector, cable length: 200mm

### Environmental data

Ambient temp. (operation/storage)	-40°C ... +60°C / -40°C ... +70°C
Protective circuit <sup>6)</sup>	2, 3
VDE safety class <sup>7)</sup>	II, all-insulated
Protection class	IP 67, IP 69K
LED class	1 (acc. to EN 60825-1)
Standards applied	IEC 60947-5-2
Certifications	UL 508 <sup>4)</sup>

### Options

<b>Warning output autoControl</b>	PNP transistor, counting principle
Signal voltage high/low	≥ ( $U_B - 2V$ ) / ≤ 2V
Output current	max. 100mA
<b>Activation input active</b>	
Transmitter active/not active	≥ 8V / ≤ 2V
Activation/disable delay	≤ 1ms
Input resistance	10kΩ ± 10%

- 1) Typ. operating range limit: max. attainable range without performance reserve
- 2) Operating range: recommended range with performance reserve
- 3) Average life expectancy 100,000 h at an ambient temperature of 25°C
- 4) For UL applications: for use in class 2 circuits only
- 5) The push-pull switching outputs must not be connected in parallel
- 6) 2=polarity reversal protection, 3=short-circuit protection for all transistor outputs
- 7) Rating voltage 50V

## Tables

0	50	60
---	----	----

	Operating range [m]
	Typ. operating range limit [m]

## Diagrams

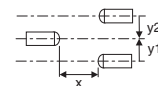
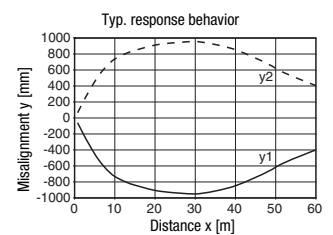

## Remarks

A light axis consists of a transmitter and a receiver with the following designations:

- (I)LSR = complete light axis
- LSSR = transmitter
- (I)LSER = receiver

- **Approved purpose:**  
This product may only be used by qualified personnel and must only be used for the approved purpose. This sensor is not a safety sensor and is not to be used for the protection of persons.
- **Alignment indicator:**  
(‘E’ see dimensioned drawing)  
**Yellow LED =**  
light path free - with reserve  
**Yellow LED, flashing =**  
light path free - no performance reserve

## LSR 46B

## Throughbeam photoelectric sensor with alignment indicator

### Order guide

The sensors listed here are preferred types; current information at [www.leuze.com](http://www.leuze.com).

	Designation	Part no.
<b>With M12 connector</b>		
Complementary switching output	LSSR 46B-S12	50108526 (Tr)
	LSER 46B/66-S12	50108532 (R)
Activation input, complementary switching output	LSSR 46B.8-S12	50108527 (Tr)
	LSER 46B/66-S12	50108532 (R)
Warning output, display low performance reserve	LSSR 46B-S12	50108526 (Tr)
	ILSER 46B/4-S12	50108536 (R)
Sensitivity adjustment, complementary switching output	LSSR 46B-S12	50108526 (Tr)
	LSER 46B/66.1-S12	50108533 (R)
<b>Cable with M12 connector</b>		
Complementary switching output	LSSR 46B,200-S12	50108528 (Tr)
	LSER 46B/66,200-S12	50108534 (R)
<b>Cable, cable length 2m</b>		
Complementary switching output	LSSR 46B	50108529 (Tr)
	LSER 46B/66	50108535 (R)

### Type key

L	S	E	R	4	6	B	/	6	6	D	.	1	-	S	1	2
---	---	---	---	---	---	---	---	---	---	---	---	---	---	---	---	---

#### Operating principle

LSSR	Throughbeam photoelectric sensor, transmitter with light visible red light
LSER	Throughbeam photoelectric sensor, receiver
ILSER	Throughbeam photoelectric sensor, receiver with warning output

#### Series

46B	46B Series
-----	------------

#### Switching output

/66	Complementary push-pull switching outputs
/4	Pin 4 PNP switching output, pin 2 no contact or warning output

#### Function characteristics

N/A	Pin 4 light switching; with push-pull, PNP light switching
D	Inverted switching logic

#### Special function

.8	Activation input (on transmitter)
.1	Sensitivity adjustment (on receiver)

#### Electrical connection

N/A	Cable, standard length 2000mm
,200-S12	Cable, length 200 mm with M12 connector
-S12	M12 connector

