

HRTR 3B "VXL"

Reflection light scanner with background suppression

en 01-2013/05 50122233



Dimensioned drawing

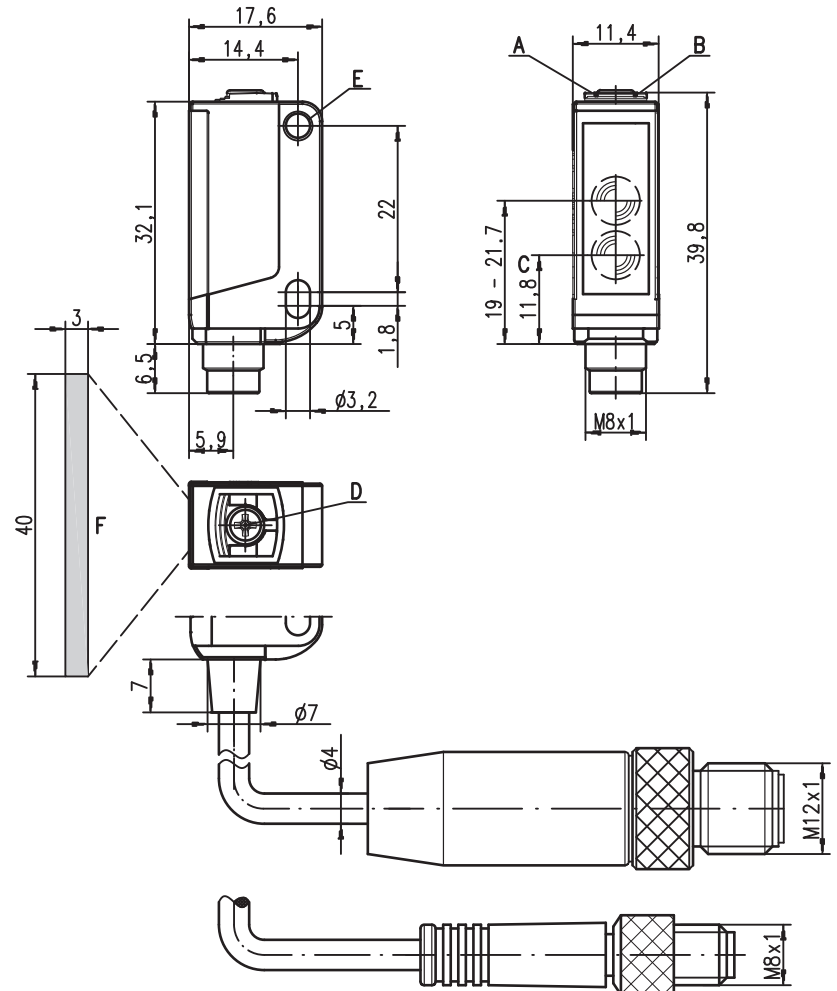

- A** Green indicator diode
- B** Yellow indicator diode
- C** Optical axis
- D** 8-turn potentiometer for scanning range adjustment
- E** Mounting sleeve
- F** Light spot of 5x30mm at a scanning range of 70mm



10 ... 90mm
80mm with
black-white error < 20%



- Reflection light scanner with visible red light
- Rectangular light spot guarantees the reliable detection of:
 - Top layers of syringe trays
 - Top layers of ampule trays
 - Paper and plastic webs in front of glass containers
- Small and compact construction with robust plastic housing, protection class IP 67 for industrial application
- A²LS- Active Ambient Light Suppression
- Push-pull switching outputs

Electrical connection

Connector, 4-pin

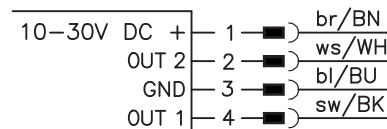

Cable, 4 wires

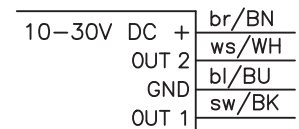

Connector, 3-pin

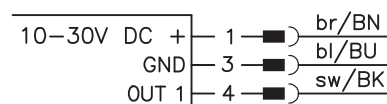

Accessories:

(available separately)

- Mounting systems (BT 3...)
- Cable with M8 or M12 connector (K-D ...)

We reserve the right to make changes • DS_HRTR3B_VXL_en_50122233.fm

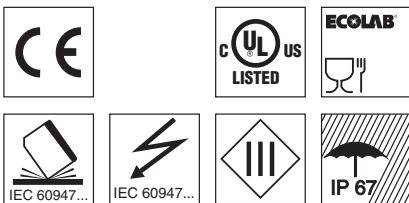

Specifications

Optical data

Typ. scanning range limit ¹⁾ 10 ... 90mm
 Scanning range ²⁾ see tables
 Adjustment range 20 ... 90mm
 Light spot approx. 5 x 30mm² at 70mm
 Light source ³⁾ LED (modulated light)
 Wavelength 620nm (visible red light)

Timing

Switching frequency 1,000Hz
 Response time 0.5ms
 Delay before start-up ≤ 300ms (acc. to. IEC 60947-5-2)

Electrical data

Operating voltage U_B ⁴⁾ 10 ... 30VDC (incl. residual ripple)
 Residual ripple ≤ 15% of U_B
 Open-circuit current ≤ 15mA
 Switching output .../66 ⁵⁾ 2 push-pull switching outputs
 pin 2: PNP dark switching, NPN light switching
 pin 4: PNP light switching, NPN dark switching
 .../6 ⁵⁾ 1 push-pull switching output
 pin 4: PNP light switching, NPN dark switching
 light/dark switching
 Signal voltage high/low ≥ ($U_B - 2V$) / ≤ 2V
 Output current max. 100mA
 Scanning range adjustable via 8-turn potentiometer

Indicators

Green LED ready
 Yellow LED object detected - reflection

Mechanical data

Housing ⁶⁾ plastic (PC-ABS); 1 attachment sleeve, nickel-plated steel
 Optics cover plastic (PMMA)
 Weight with connector: 10g
 with 200mm cable and connector: 20g
 with 2m cable: 50g
 2m cable (cross section 4x0.20mm²),
 connector M8 metal,
 0.2m cable with connector M8 or M12

Connection type

Environmental data

Ambient temp. (operation/storage) -30°C ... +55°C / -30°C ... +70°C
 Protective circuit ⁷⁾ 2, 3
 VDE safety class III
 Protection class IP 67
 Light source Exempt group (in acc. with EN 62471)
 Standards applied IEC 60947-5-2
 Certifications UL 508 ⁴⁾

- 1) Typ. scan. range limit: max. achievable scanning range for light objects (white 90%)
- 2) Scanning range: recommended scanning range for objects with different diffuse reflection
- 3) Average life expectancy 100,000h at an ambient temperature of 25°C
- 4) For UL applications: for use in class 2 circuits according to NEC only
- 5) The push-pull switching outputs must not be connected in parallel
- 6) Patent Pending Publ. No. US 7,476,848 B2
- 7) 2=polarity reversal protection, 3=short circuit protection for all transistor outputs

Remarks

Adapter plate:

BT 3.2 (part no. 50103844) for alternate mounting on 25.4 mm hole spacing (Omron E3Z, Sick W100...)

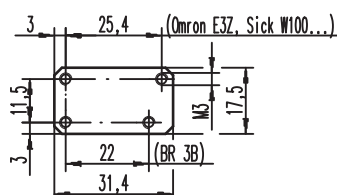

Tables

1	10	80	90
2	12	70	75
3	12	60	65

1	white 90%
2	gray 18%
3	black 6%

Scanning range [mm]
 Typ. scanning range limit [mm]

Diagrams

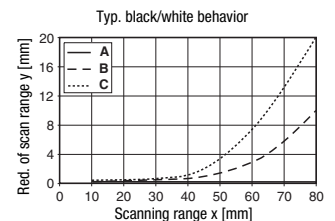
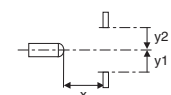
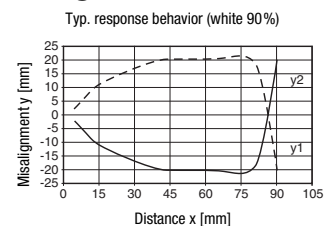

- A white 90%
- B gray 18%
- C black 6%

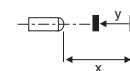

Remarks

Mounting system:



- ① = BT 3 (part no. 50060511)
- ②+③ = BT 3.1 ¹⁾ (part no. 50105585)
- ①+②+③ = BT 3B (part no. 50105546)

1) Packaging unit: PU = 10 pcs.

HRTR 3B "VXL"

Reflection light scanner with background suppression

Order guide

Selection table		Order code →
Equipment ↓		HRTR 3B/66-VXL-S8 Part no. 50122262
Switching output	2 x push-pull switching output 1 x push-pull switching output	●
Switching function	1 PNP light switching and NPN dark switching output	●
	1 PNP dark switching and NPN light switching output	●
Connection	M8 connector, metal, 4-pin	●
	M8 connector, metal, 3-pin	
	200mm cable with M8 connector, 4-pin	
	2000mm cable, 4-wire	
Indicators	green LED: ready	●
	yellow LED: switching output	●

Application notes



- **Approved purpose:**
This product may only be used by qualified personnel and must only be used for the approved purpose. This sensor is not a safety sensor and is not to be used for the protection of persons.
- Install the sensor at a distance of 60 ... 80mm from the top layer.
- Position the sensor at an approx. 20° angle (tip plug side towards the top layer).
- Set the sensor with the adjusting spindle so that the top layer will be detected reliably.

