

## Technical data sheet

### Switch cabinet

Part no.: 50142330

LSC708-000-100

#### Contents

- Technical data
- Dimensioned drawings
- Electrical connection
- Notes
- Accessories



For illustration purposes only

## Technical data

### Basic data

Series	CMS 7xxi
Suitable for	CMS 700i contour measurement system

### Electrical data

Protective circuit	Polarity reversal protection
	Short circuit protected
	Transient protection
Output current, continuous current per channel, max.	100 mA

### Performance data

Supply voltage $U_B$	100 ... 263 V
Open-circuit current	250 mA

### Inputs

Number of digital switching inputs	4 Piece(s)
------------------------------------	------------

### Switching inputs

Type	Digital switching input
Voltage type	DC
Switching voltage	24 V, VIN

### Outputs

Number of digital switching outputs	4 Piece(s)
-------------------------------------	------------

### Switching outputs

Type	Digital switching output
Voltage type	AC
Switching voltage	24 V, VIN

### Interface

Type	EtherNet TCP/IP
<b>Ethernet</b>	
Function	Configuration / process data

### Connection

Number of connections	11 Piece(s)
<b>Connection 1</b>	
Function	Earthing
Type of connection	Screw fitting
Material	Metal
<b>Connection 2</b>	
Function	Voltage supply
Type of connection	Mains plug
Material	Metal
<b>Connection 3</b>	
Function	External Ethernet TCP/IP connection
Type of connection	Connector
Thread size	M12
Type	Female
Material	Metal
No. of pins	4 -pin
Encoding	D-coded

### Connection 4

Type of connection	Connector
Thread size	M12
Type	Female
Material	Metal
No. of pins	8 -pin
Encoding	A-coded

### Connection 5

Function	Rotary encoder connection (not in combination with length measuring light curtain)
Type of connection	Connector
Thread size	M12
Type	Female
Material	Metal
No. of pins	8 -pin
Encoding	A-coded

### Connection 6

Function	Digital switching input
Type of connection	Connector
Thread size	M12
Type	Female
Material	Metal
No. of pins	4 -pin
Encoding	A-coded

### Connection 7

Function	Digital switching input
Type of connection	Connector
Thread size	M12
Type	Female
Material	Metal
No. of pins	4 -pin
Encoding	A-coded

### Connection 8

Function	Digital switching output
Type of connection	Connector
Thread size	M12
Type	Female
Material	Metal
No. of pins	4 -pin
Encoding	A-coded

### Connection 9

Function	Digital switching output
Type of connection	Connector
Thread size	M12
Type	Female
Material	Metal
No. of pins	4 -pin
Encoding	A-coded

### Mechanical data

Design	Cubic
Dimension (W x H x L)	380 mm x 380 mm x 210 mm
Housing material	Metal
Housing color	Gray

## Technical data

### Operation and display

Type of display	LED
Number of LEDs	3 Piece(s)
Type of configuration	performed via webConfig
Operational controls	Rotary switch

### Environmental data

Ambient temperature, operation	0 ... 45 °C
Ambient temperature, storage	-20 ... 70 °C

### Classification

ECLASS 5.1.4	27279290
ECLASS 8.0	27279290
ECLASS 9.0	27270992
ECLASS 10.0	27270992
ECLASS 11.0	27270992
ECLASS 12.0	27270992
ECLASS 13.0	27270992
ECLASS 14.0	27270992
ETIM 5.0	EC002498
ETIM 6.0	EC003015
ETIM 7.0	EC003015
ETIM 8.0	EC003015
ETIM 9.0	EC003015

## Dimensioned drawings

All dimensions in millimeters

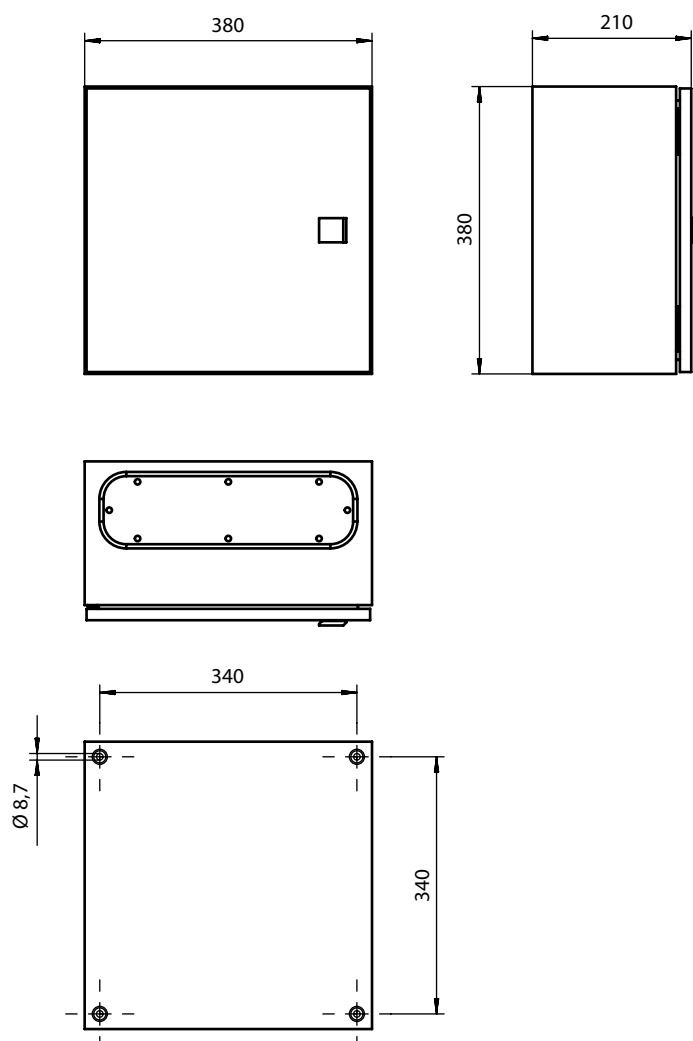

# Dimensioned drawings

## Switch cabinet connection diagram

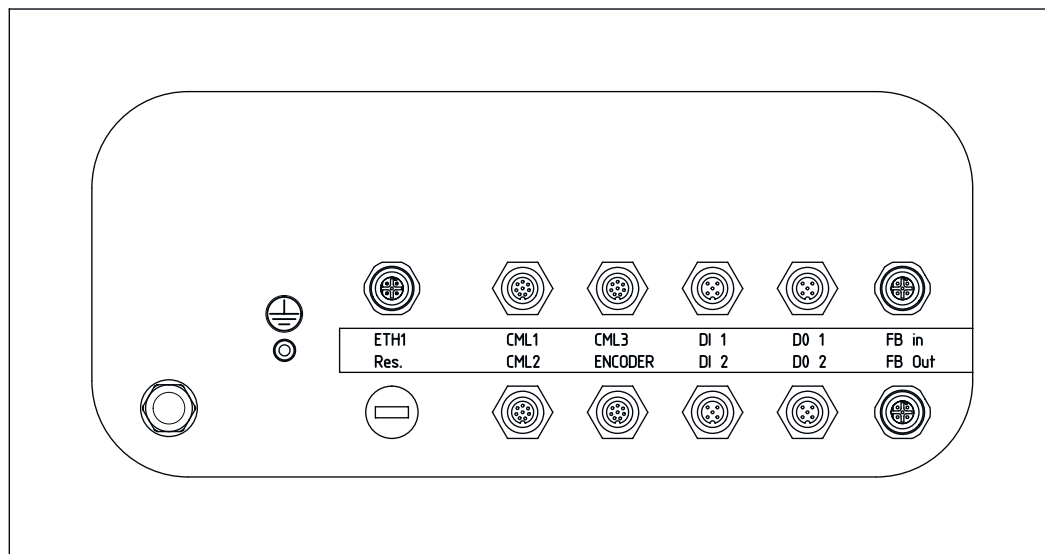

## Electrical connection

### Connection 1

Function	Earthing
Type of connection	Screw fitting
Material	Metal

### Connection 2

Function	Voltage supply
Type of connection	Mains plug
Material	Metal

### Connection 3

### ETH1

Function	External Ethernet TCP/IP connection
Type of connection	Connector
Thread size	M12
Type	Female
Material	Metal
No. of pins	4 -pin
Encoding	D-coded

Pin	Pin assignment
1	TD+
2	RD+
3	TD-
4	RD-

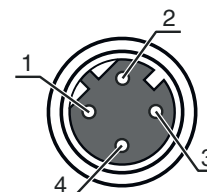

## Electrical connection

### Connection 4

### CML1 / CML2 / CML3

Type of connection	Connector
Type of connection	applicable for the connections CML1, CML2 and CML3
Thread size	M12
Type	Female
Material	Metal
No. of pins	8 -pin
Encoding	A-coded

#### Pin Pin assignment

Pin	Pin assignment
1	V+
2	IO1
3	GND
4	IO-Link
5	IO2
6	IO3
7	IO4
8	GND

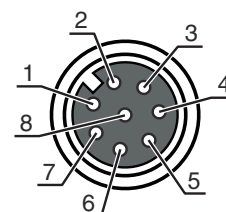

### Connection 5

### Encoder

Function	Rotary encoder connection (not in combination with length measuring light curtain)
Type of connection	Connector
Thread size	M12
Type	Female
Material	Metal
No. of pins	8 -pin
Encoding	A-coded

#### Pin Pin assignment

Pin	Pin assignment
1	U-
2	U+
3	A
4	B
5	N
6	A inv.
7	B inv.
8	N inv.

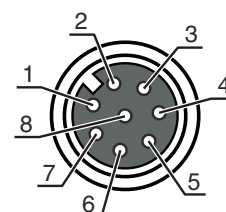

### Connection 6

### DI1

Function	Digital switching input
Type of connection	Connector
Thread size	M12
Type	Female
Material	Metal
No. of pins	4 -pin
Encoding	A-coded

#### Pin Pin assignment

Pin	Pin assignment
1	+24 V
2	DI1
3	GND
4	DI2

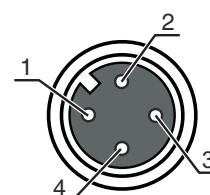

## Electrical connection

### Connection 7

### DI2

Function	Digital switching input
Type of connection	Connector
Thread size	M12
Type	Female
Material	Metal
No. of pins	4 -pin
Encoding	A-coded

Pin	Pin assignment
-----	----------------

1	+24 V
2	DI3
3	GND
4	DI4

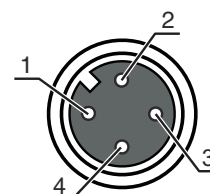

### Connection 8

### DO1

Function	Digital switching output
Type of connection	Connector
Thread size	M12
Type	Female
Material	Metal
No. of pins	4 -pin
Encoding	A-coded

Pin	Pin assignment
-----	----------------

1	+24 V
2	DO1
3	GND
4	DO2

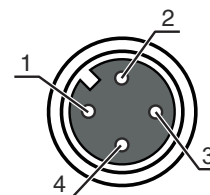

### Connection 9

### DO2

Function	Digital switching output
Type of connection	Connector
Thread size	M12
Type	Female
Material	Metal
No. of pins	4 -pin
Encoding	A-coded

Pin	Pin assignment
-----	----------------

1	+24 V
2	DO3
3	GND
4	DO4

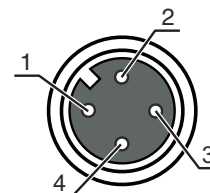

## Notes



**Observe intended use!**



- ⚠ This product is not a safety sensor and is not intended as personnel protection.
- ⚠ The product may only be put into operation by competent persons.
- ⚠ Only use the product in accordance with its intended use.

## Accessories

### Connection technology - Interconnection cables

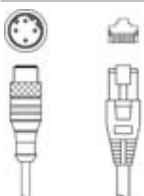
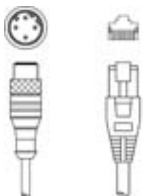
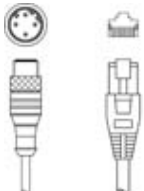
	Part no.	Designation	Article	Description
	50135082	KSS ET-M12-4A-RJ45-A-P7-100	Interconnection cable	Suitable for interface: Ethernet Connection 1: Connector, M12, Axial, Male, D-coded, 4 -pin Connection 2: RJ45 Shielded: Yes Cable length: 10,000 mm Sheathing material: PUR
	50135083	KSS ET-M12-4A-RJ45-A-P7-150	Interconnection cable	Suitable for interface: Ethernet Connection 1: Connector, M12, Axial, Male, D-coded, 4 -pin Connection 2: RJ45 Shielded: Yes Cable length: 15,000 mm Sheathing material: PUR
	50135084	KSS ET-M12-4A-RJ45-A-P7-300	Interconnection cable	Suitable for interface: Ethernet Connection 1: Connector, M12, Axial, Male, D-coded, 4 -pin Connection 2: RJ45 Shielded: Yes Cable length: 30,000 mm Sheathing material: PUR

#### Note



- ⚠ A list with all available accessories can be found on the Leuze website in the Download tab of the article detailed page.