

## Technical data sheet

### Contour measurement system

Part no.: 50143582  
CMS708i-ENC1-0640-0720

#### Contents

- Set consists of
- Technical data
- Dimensioned drawings
- Electrical connection
- Diagrams
- Notes
- Accessories



For illustration purposes only



# Set consists of

|   | Quantity | Part no. | Designation                 | Article                   | Description  |
|---|----------|----------|-----------------------------|---------------------------|--|
|     | 2        | 424417   | BT-2P40                     | Mounting bracket set      | Bore hole 1: M6<br>Bore hole 2: M6<br>Design of mounting device: Mounting clamp<br>Fastening, at system: Groove mounting<br>Mounting bracket, at device: Groove mounting<br>Type of mounting device: Clampable, Suitable for mounting in UDC-S2, DC-S2 device columns<br>Material: Metal |
|    | 1        | 50118744 | CML730i-R05-640.A/L-M12     | Light curtain receiver    | Operating range: 0.1 ... 4.5 m<br>Interface: IO-Link<br>Connection: Connector, M12, Axial, 8 -pin  |
|    | 1        | 50118745 | CML730i-R05-720.A/L-M12     | Light curtain receiver    | Operating range: 0.1 ... 4.5 m<br>Interface: IO-Link<br>Connection: Connector, M12, Axial, 8 -pin  |
|   | 1        | 50118583 | CML730i-T05-640.A-M12       | Light curtain transmitter | Operating range: 0.1 ... 4 m<br>Connection: Connector, M12, Axial, 5 -pin  |
|  | 1        | 50118584 | CML730i-T05-720.A-M12       | Light curtain transmitter | Operating range: 0.1 ... 4 m<br>Connection: Connector, M12, Axial, 5 -pin  |
|  | 2        | 50129781 | KDS DN-M12-5A-M12-5A-P3-050 | Interconnection cable     | Suitable for interface: DeviceNet, CANopen<br>Connection 1: Connector, M12, Axial, Female, A-coded, 5 -pin<br>Connection 2: Connector, M12, Axial, Male, A-coded, 5 -pin<br>Shielded: Yes<br>Cable length: 5,000 mm<br>Sheathing material: PUR   |
|  | 3        | 50135146 | KDS S-M12-8A-M12-8A-P1-050  | Interconnection cable     | Connection 1: Connector, M12, Axial, Female, A-coded, 8 -pin<br>Connection 2: Connector, M12, Axial, Male, A-coded, 8 -pin<br>Shielded: Yes<br>Cable length: 5,000 mm<br>Sheathing material: PUR   |
|  | 1        | 50144568 | LMSMA35500024KH 10M16       | Rotary encoder            |  |
|   | 1        | 50142930 | LSC708-ENC-100              | Switch cabinet            | Supply voltage: 100 ... 263 V, AC<br>Switching inputs: 4 Piece(s)<br>Switching outputs: 4 Piece(s)<br>Connections: 11 Piece(s)   |

## Technical data

### Basic data

|             |                                       |
|-------------|---------------------------------------|
| Series      | CMS 7xxi                              |
| Contains    | 1x dongle CMS700<br>1x rotary encoder |
| Order guide | Additional models on request          |

### Functions

|           |   |
|-----------|---|
| Functions | For a minimum object height $\geq 5$ mm |
|-----------|---|

### Optical data

|                                    |                            |
|------------------------------------|----------------------------|
| Operating range                    | 0.1 ... 4.5 m              |
| Operating range                    | Guaranteed operating range |
| Operating range, transparent media | 0.1 ... 1.75 m             |
| Operating range limit              | Typical operating range    |
| Operating range limit              | 0.1 ... 6 m                |
| Measurement field length 1         | 640 mm                     |
| Measurement field length 2         | 720 mm                     |
| Beam spacing                       | 5 mm                       |

### Electrical data

|  |   |
|--|---|
| Protective circuit                                   | Polarity reversal protection<br>Short circuit protected<br>Transient protection |
| Output current, continuous current per channel, max. | 100 mA  |

#### Performance data

|                      |               |
|----------------------|---------------|
| Supply voltage $U_B$ | 100 ... 263 V |
| Open-circuit current | 250 mA        |

#### Inputs

|                                    |            |
|------------------------------------|------------|
| Number of digital switching inputs | 4 Piece(s) |
|------------------------------------|------------|

#### Switching inputs

|                   |                         |
|-------------------|-------------------------|
| Type              | Digital switching input |
| Voltage type      | DC                      |
| Switching voltage | 24 V, VIN               |

#### Outputs

|                                     |            |
|-------------------------------------|------------|
| Number of digital switching outputs | 4 Piece(s) |
|-------------------------------------|------------|

#### Switching outputs

|                   |                          |
|-------------------|--------------------------|
| Type              | Digital switching output |
| Voltage type      | AC                       |
| Switching voltage | 24 V, VIN                |

### Interface

|                   |                              |
|-------------------|------------------------------|
| Type              | EtherNet TCP/IP              |
| Ethernet Function | Configuration / process data |

### Connection

|                       |             |
|-----------------------|-------------|
| Number of connections | 11 Piece(s) |
|-----------------------|-------------|

#### Connection 1

|                    |               |
|--------------------|---------------|
| Function           | Earthing      |
| Type of connection | Screw fitting |
| Material           | Metal         |

#### Connection 2

|                    |                |
|--------------------|----------------|
| Function           | Voltage supply |
| Type of connection | Mains plug     |
| Material           | Metal          |

#### Connection 3

|                    |  |
|--------------------|--|
| Function           | Width measuring light curtain connection |
| Type of connection | Connector                                |
| Thread size        | M12                                      |
| Type               | Female                                   |
| Material           | Metal                                    |
| No. of pins        | 4 -pin                                   |
| Encoding           | D-coded                                  |

#### Connection 4

|                    |   |
|--------------------|---|
| Function           | Height measuring light curtain connection |
| Type of connection | Connector                                 |
| Thread size        | M12                                       |
| Type               | Female                                    |
| Material           | Metal                                     |
| No. of pins        | 8 -pin                                    |
| Encoding           | A-coded                                   |

#### Connection 5

|                    |  |
|--------------------|--|
| Function           | Rotary encoder connection (not in combination with length measuring light curtain) |
| Type of connection | Connector  |
| Thread size        | M12  |
| Type               | Female   |
| Material           | Metal  |
| No. of pins        | 8 -pin   |
| Encoding           | A-coded  |

#### Connection 6

|                    |                                     |
|--------------------|-------------------------------------|
| Function           | External Ethernet TCP/IP connection |
| Type of connection | Connector                           |
| Thread size        | M12                                 |
| Type               | Female                              |
| Material           | Metal                               |
| No. of pins        | 4 -pin                              |
| Encoding           | A-coded                             |

#### Connection 7

|                    |                                   |
|--------------------|-----------------------------------|
| Function           | PROFINET IN connection (optional) |
| Type of connection | Connector                         |
| Thread size        | M12                               |
| Type               | Female                            |
| Material           | Metal                             |
| No. of pins        | 4 -pin                            |
| Encoding           | A-coded                           |

#### Connection 8

|                    |           |
|--------------------|-----------|
| Type of connection | Connector |
| Thread size        | M12       |
| Type               | Female    |
| Material           | Metal     |
| No. of pins        | 4 -pin    |
| Encoding           | A-coded   |

## Technical data

### Connection 9

|                    |           |
|--------------------|-----------|
| Type of connection | Connector |
| Thread size        | M12       |
| Type               | Female    |
| Material           | Metal     |
| No. of pins        | 4 -pin    |
| Encoding           | A-coded   |

### Mechanical data

|                     |  |
|---------------------|--|
| Design              | Cubic  |
| Housing material    | Metal  |
| Metal housing       | Aluminum   |
| Lens cover material | Plastic  |
| Housing color       | Gray   |
|                     | Red  |
| Note                | Dimensions of individual set items, see dimensioned drawings |

### Operation and display

|                       |                         |
|-----------------------|-------------------------|
| Type of display       | LED                     |
| Number of LEDs        | 3 Piece(s)              |
| Type of configuration | performed via webConfig |
| Operational controls  | Rotary switch           |

### Environmental data

|                                |               |
|--------------------------------|---------------|
| Ambient temperature, operation | 0 ... 45 °C   |
| Ambient temperature, storage   | -20 ... 70 °C |

### Classification

|                       |          |
|-----------------------|----------|
| Customs tariff number | 90314990 |
| ECLASS 5.1.4          | 27270910 |
| ECLASS 8.0            | 27270910 |
| ECLASS 9.0            | 27270910 |
| ECLASS 10.0           | 27270910 |
| ECLASS 11.0           | 27270910 |
| ECLASS 12.0           | 27270910 |
| ECLASS 13.0           | 27270910 |
| ECLASS 14.0           | 27270910 |
| ETIM 5.0              | EC002549 |
| ETIM 6.0              | EC002549 |
| ETIM 7.0              | EC002549 |
| ETIM 8.0              | EC002549 |
| ETIM 9.0              | EC002549 |

## Dimensioned drawings

All dimensions in millimeters

### Light curtain transmitter and receiver



- |   |                                     |   |                           |
|---|-------------------------------------|---|---------------------------|
| A | Beam spacing 5 mm                   | L | Profile length 1 = 648 mm |
| B | Measurement field length 1 = 640 mm | L | Profile length 2 = 728 mm |
| B | Measurement field length 2 = 720 mm | T | Transmitter               |
| F | M6 thread                           | R | Receiver                  |
| G | Fastening groove                    | Y | 2.5 mm                    |

## Dimensioned drawings

### Switch cabinet

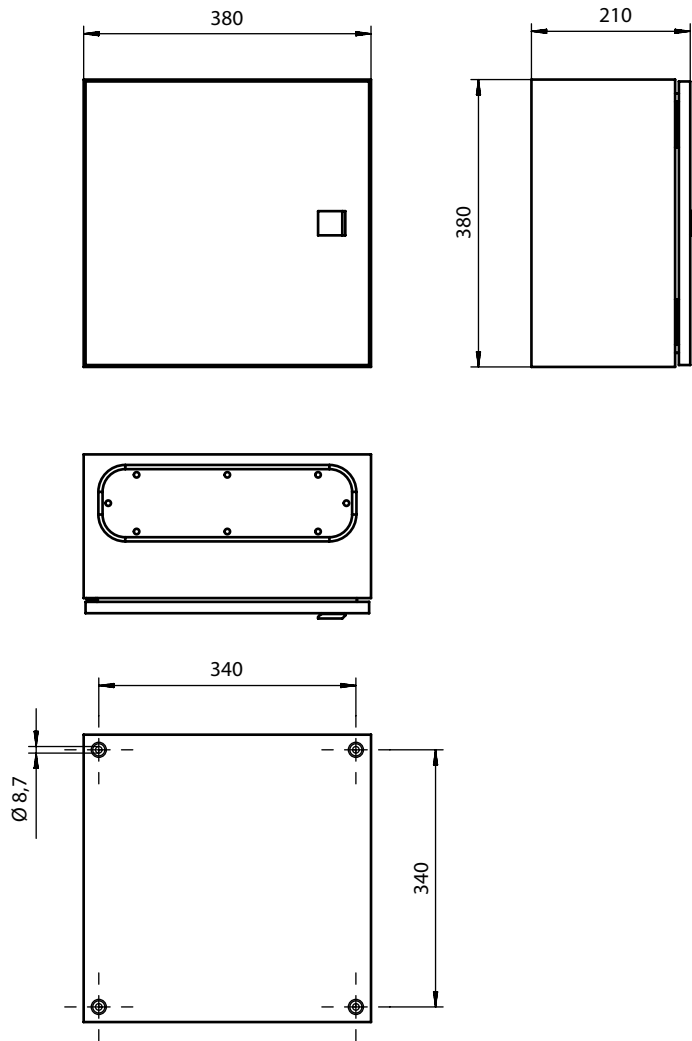

## Dimensioned drawings

### Rotary encoders

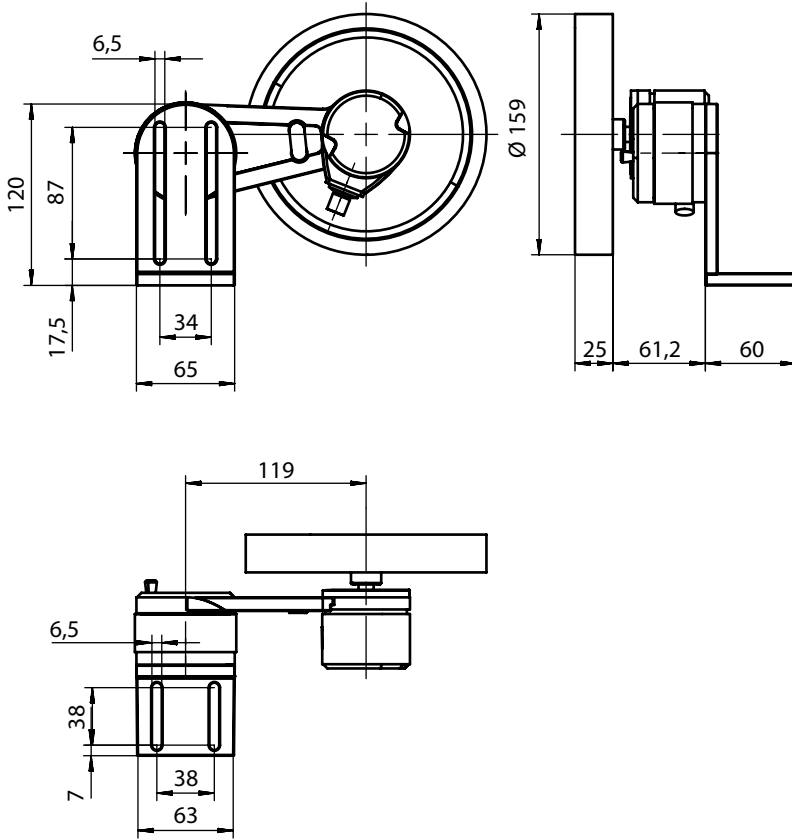

## Dimensioned drawings

### Mounting bracket



## Electrical connection

### Connection 1

|                    |               |
|--------------------|---------------|
| Function           | Earthing      |
| Type of connection | Screw fitting |
| Material           | Metal         |

### Connection 2

|                    |                |
|--------------------|----------------|
| Function           | Voltage supply |
| Type of connection | Mains plug     |
| Material           | Metal          |

### Connection 3

### ETH1

|                    |  |
|--------------------|--|
| Function           | Width measuring light curtain connection |
| Type of connection | Connector                                |
| Thread size        | M12                                      |
| Type               | Female                                   |
| Material           | Metal                                    |
| No. of pins        | 4 -pin                                   |
| Encoding           | D-coded                                  |



## Electrical connection

| Pin | Pin assignment |
|-----|----------------|
| 1   | TD+            |
| 2   | RD+            |
| 3   | TD-            |
| 4   | RD-            |



| Connection 4       | CML1 / CML2 / CML3                        |
|--------------------|---|
| Function           | Height measuring light curtain connection |
| Type of connection | Connector                                 |
| Thread size        | M12                                       |
| Type               | Female                                    |
| Material           | Metal                                     |
| No. of pins        | 8 -pin                                    |
| Encoding           | A-coded                                   |

| Pin | Pin assignment |
|-----|----------------|
| 1   | V+             |
| 2   | IO1            |
| 3   | GND            |
| 4   | IO-Link        |
| 5   | IO2            |
| 6   | IO3            |
| 7   | IO4            |
| 8   | GND            |

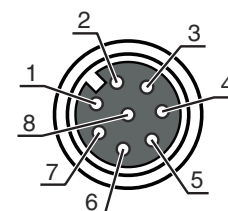

| Connection 5       | Encoder  |
|--------------------|--|
| Function           | Rotary encoder connection (not in combination with length measuring light curtain) |
| Type of connection | Connector  |
| Thread size        | M12  |
| Type               | Female   |
| Material           | Metal  |
| No. of pins        | 8 -pin   |
| Encoding           | A-coded  |

| Pin | Pin assignment |
|-----|----------------|
| 1   | U-             |
| 2   | U+             |
| 3   | A              |
| 4   | B              |
| 5   | N              |
| 6   | A inv.         |
| 7   | B inv.         |
| 8   | N inv.         |
| 9   | Shield         |

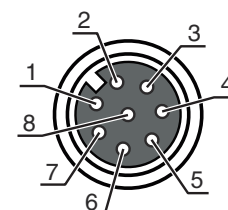

| Connection 6       | DI1                                 |
|--------------------|-------------------------------------|
| Function           | External Ethernet TCP/IP connection |
| Type of connection | Connector                           |
| Thread size        | M12                                 |
| Type               | Female                              |
| Material           | Metal                               |
| No. of pins        | 4 -pin                              |
| Encoding           | A-coded                             |

## Electrical connection

| Pin | Pin assignment |
|-----|----------------|
| 1   | +24 V          |
| 2   | DI1            |
| 3   | GND            |
| 4   | DI2            |

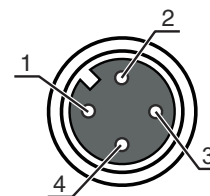

| Connection 7       | DI2                               |
|--------------------|-----------------------------------|
| Function           | PROFINET IN connection (optional) |
| Type of connection | Connector                         |
| Thread size        | M12                               |
| Type               | Female                            |
| Material           | Metal                             |
| No. of pins        | 4 -pin                            |
| Encoding           | A-coded                           |

| Pin | Pin assignment |
|-----|----------------|
| 1   | +24 V          |
| 2   | DI3            |
| 3   | GND            |
| 4   | DI4            |

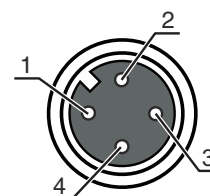

| Connection 8       |           |
|--------------------|-----------|
| Type of connection | Connector |
| Thread size        | M12       |
| Type               | Female    |
| Material           | Metal     |
| No. of pins        | 4 -pin    |
| Encoding           | A-coded   |

| Pin | Pin assignment |
|-----|----------------|
| 1   | +24 V          |
| 2   | DO1            |
| 3   | GND            |
| 4   | DO2            |

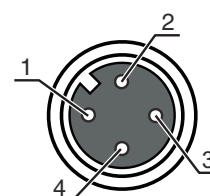

| Connection 9       |           |
|--------------------|-----------|
| Type of connection | Connector |
| Thread size        | M12       |
| Type               | Female    |
| Material           | Metal     |
| No. of pins        | 4 -pin    |
| Encoding           | A-coded   |

| Pin | Pin assignment |
|-----|----------------|
| 1   | +24 V          |
| 2   | DO3            |
| 3   | GND            |
| 4   | DO4            |

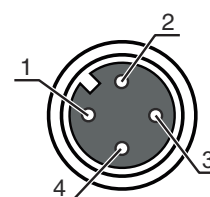

# Diagrams



x Total measuring length from width and height measuring light curtain [mm]  
 y Max. conveyor speed [m/s]

## Notes

**Observe intended use!**

- This product is not a safety sensor and is not intended as personnel protection.
- The product may only be put into operation by competent persons.
- Only use the product in accordance with its intended use.

## Accessories

### Connection technology - Interconnection cables

|  | Part no. | Designation                 | Article               | Description   |
|--|----------|-----------------------------|-----------------------|---|
|  | 50135082 | KSS ET-M12-4A-RJ45-A-P7-100 | Interconnection cable | Suitable for interface: Ethernet<br>Connection 1: Connector, M12, Axial, Male, D-coded, 4 -pin<br>Connection 2: RJ45<br>Shielded: Yes<br>Cable length: 10,000 mm<br>Sheathing material: PUR |

## Accessories

|  | Part no. | Designation                 | Article               | Description   |
|--|----------|-----------------------------|-----------------------|---|
|  | 50135083 | KSS ET-M12-4A-RJ45-A-P7-150 | Interconnection cable | Suitable for interface: Ethernet<br>Connection 1: Connector, M12, Axial, Male, D-coded, 4 -pin<br>Connection 2: RJ45<br>Shielded: Yes<br>Cable length: 15,000 mm<br>Sheathing material: PUR |
|  | 50135084 | KSS ET-M12-4A-RJ45-A-P7-300 | Interconnection cable | Suitable for interface: Ethernet<br>Connection 1: Connector, M12, Axial, Male, D-coded, 4 -pin<br>Connection 2: RJ45<br>Shielded: Yes<br>Cable length: 30,000 mm<br>Sheathing material: PUR |

## Mounting technology - Other

| Part no. | Designation   | Article             | Description   |
|----------|---------------|---------------------|---|
| 50143670 | BT 708M-MRSET | Mounting device set | Design of mounting device: Profile kit<br>Fastening, at system: Screw type / vertical<br>Mounting bracket, at device: Groove mounting<br>Type of mounting device: Rigid<br>Material: Aluminum<br>Shock absorber: No |
| 50143671 | BT 70EM-MRSET | Mounting device set | Design of mounting device: Profile kit<br>Fastening, at system: Screw type / vertical<br>Mounting bracket, at device: Groove mounting<br>Type of mounting device: Rigid<br>Material: Aluminum<br>Shock absorber: No |
| 50143669 | BT 710M-MRSET | Mounting device set | Design of mounting device: Profile kit<br>Fastening, at system: Screw type / vertical<br>Mounting bracket, at device: Groove mounting<br>Type of mounting device: Rigid<br>Material: Aluminum<br>Shock absorber: No |
| 50142039 | BT 712M-MRSET | Mounting device set | Design of mounting device: Profile kit<br>Fastening, at system: Screw type / vertical<br>Mounting bracket, at device: Groove mounting<br>Type of mounting device: Rigid<br>Material: Aluminum<br>Shock absorber: No |

### Note



A list with all available accessories can be found on the Leuze website in the Download tab of the article detailed page.