

IT 1911i

Industrial 2D-code hand-held scanner
with RF transmission



© 2013

Leuze electronic GmbH + Co. KG

In der Braike 1

D-73277 Owen / Germany

Phone: +49 7021 573-0

Fax: +49 7021 573-199

<http://www.leuze.com>

info@leuze.de

Contents

1	Scope of delivery	5
1.1	IT 1911i xx-3.....	5
1.2	Base station IT 1911i.....	5
2	Installation	6
2.1.1	Switching off the PC.....	6
2.2	Connecting the base station.....	6
2.2.1	Connecting to base station IT 1911i.....	6
2.3	How do I scan codes?	7
2.3.1	Testing the scanner.....	7
3	Technical Data	8
3.1	Pin assignments of the connection cable.....	8
3.1.1	KB 232-1 IT 190x Part no. 50114517.....	8
3.1.2	KB PS2-1 IT190x Part no. 50114519.....	8
3.1.3	KB USB-1 IT 190x Part no. 50114521	8
3.1.4	KB USB-2 IT 190x Part no. 50114523	9
3.2	Reading fields.....	9
4	Resetting the IT 1911i to factory settings	10
5	Configuration	11
5.1	IT 1911i to the serial PC interface.....	12
5.1.1	With KB 232-1 IT190x Part no. 50114517	12
5.1.2	Configuration for the Leuze standard protocol.....	13
5.2	IT 1911i to MA 200i	14
5.2.1	Commissioning.....	14
5.3	IT 1911i to MA 21	17
5.4	IT 1911i to PS2 interface.....	19
5.5	IT 1911i to USB interface (keyboard emulation).....	20
5.6	IT 1911i to USB interface (COM port emulation)	21
5.7	Activating the read process.....	22
5.8	Configuration	22
5.9	Troubleshooting.....	23
6	Type overview	24
7	Accessories/Spare parts	25
7.1	Connecting to Leuze multiNet Plus	26
7.2	Connection to various fieldbuses using MA 200i	26

1 Scope of delivery

1.1 IT 1911i xx-3

- 1. Hand-held scanner IT 1911i
- 2. Rechargeable battery (installed)
- 3. Package insert

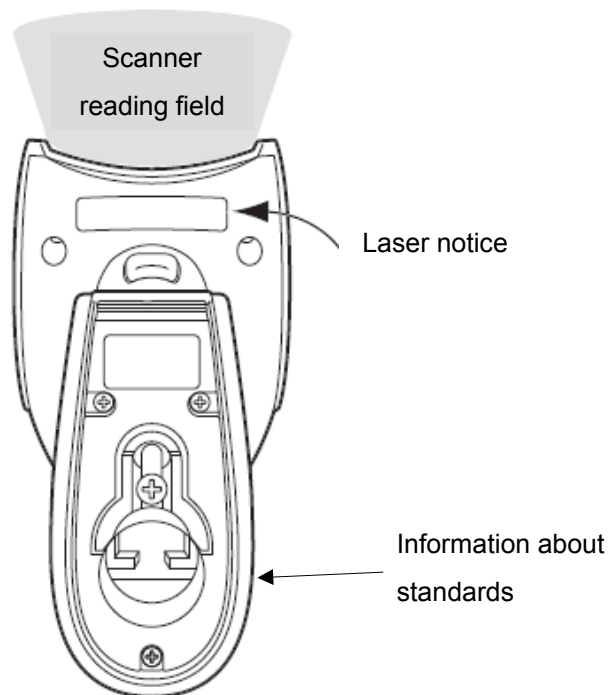

1.2 Base station IT 1911i

- 1. Base station CCB02-100BT

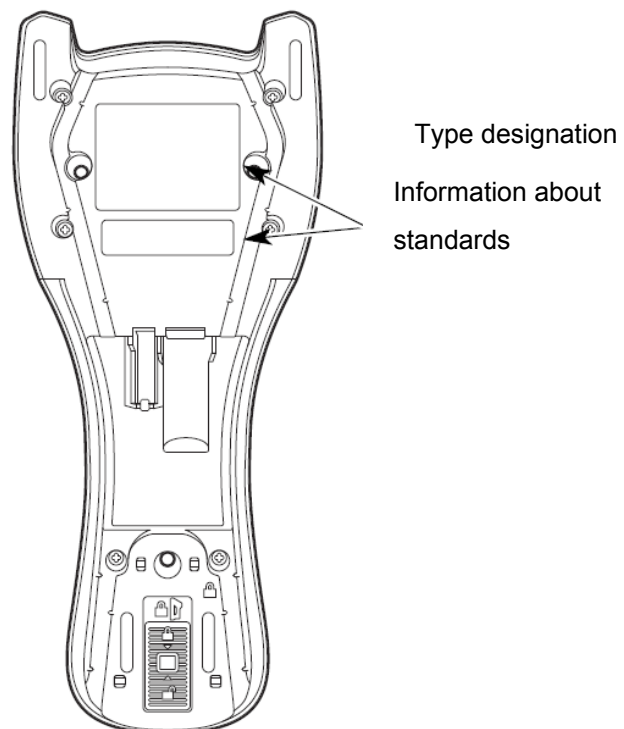

An overview of the types can be found on page 24.

For accessories, see page 25.

2 Installation

2.1.1 Switching off the PC

NOTICE
Make sure that the PC is switched off before connecting the scanner.

2.2 Connecting the base station

Shown in the figure below are the locations for installing the cable on the base station.

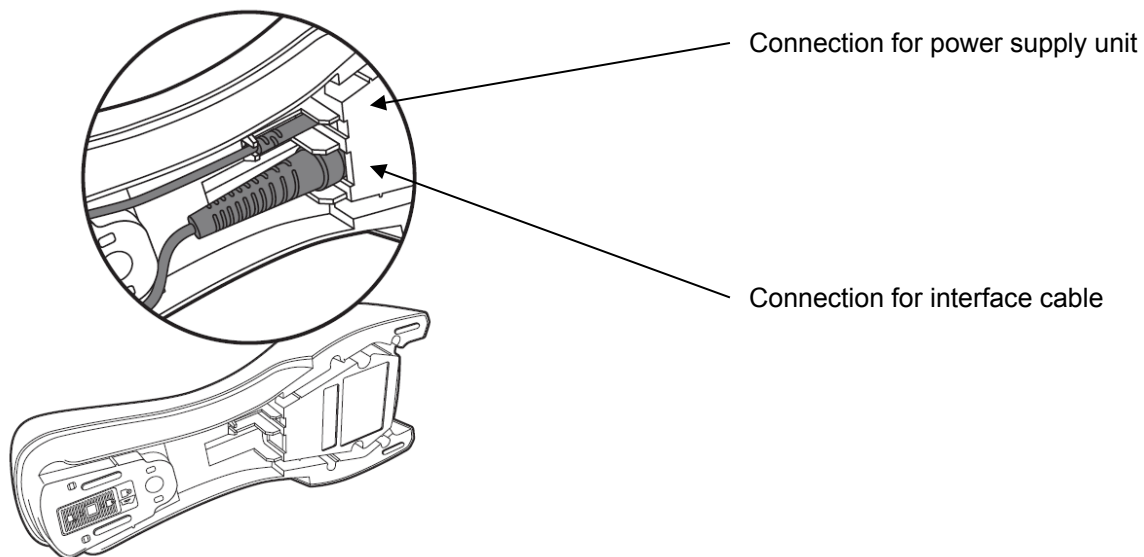

2.2.1 Connecting to base station IT 1911i

1. To secure the connection cable to the base station, proceed as follows: Insert the RJ 41 connector into the socket on the bottom of the base station until the cable clicks into place.
2. Connect the other end of the connection cable to the appropriate connection socket on the PC.
3. You may need a power supply unit for voltage supply if you would like to charge the hand-held scanner at the base station or if you use an RS 232 interface. Use the pin assignments (see page 8) to select the appropriate cable for your application.
4. Connect the power supply unit to the power socket.
5. Configure the hand-held scanner using the codes for the corresponding application; see chapter "5 Configuration" or the external document "User's Guide IT 1910i/1911i".

6. Check the operational readiness of the scanner by pointing the scanning surface towards a flat surface and pulling the trigger. A green target line as well as the red illumination should now be visible. Now scan a sample label. The scanner emits an audible signal to confirm that the label has been read; if necessary, the data are now passed on to the PC.

2.3 How do I scan codes?

This section explains the best way to scan codes:

The scanner must be held at a slight angle to the bar code. (Do not hold the scanner at a right angle to the bar code.)

The green LED line which serves as an alignment aid should be positioned at the center of the code. This ensures that the center point of the camera is aligned with the code.

(The scanner will not be able to detect the label correctly if it is not fully captured by the camera.)

The green LED line is smaller and narrower if the scanner is held closer to the code. Small codes should be read at a smaller reading distance. With larger codes, the reading distance must be large enough so that the camera can capture the complete code.

2.3.1 Testing the scanner

The adjacent bar code can be used for testing the scanner, the module size is 0.5 mm (20 mil)

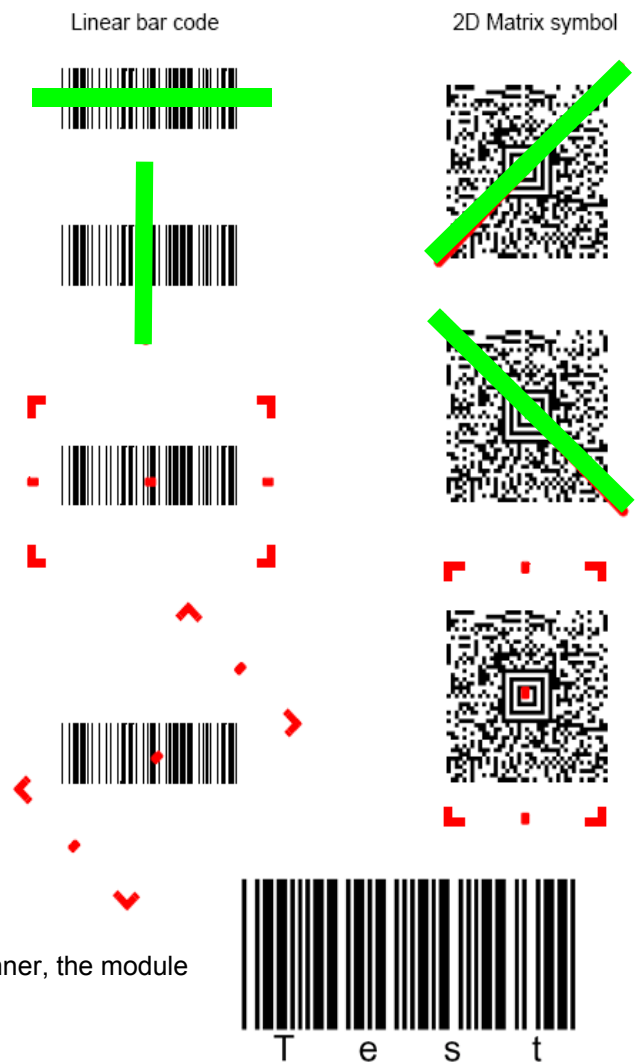

Code 39 bar code sample

3 Technical Data

The technical data can be found in the data sheet for the IT 1911i.

3.1 Pin assignments of the connection cable

3.1.1 KB 232-1 IT 190x Part no. 50114517

Helix cable, maximum length 3 m. Signal level 0 and +5 volts →TTL

Pin assignments of the 9-pin D-sub socket (female) for cable CBL-020-300-C00

Pin number	Signal	Designation
1	nc	Not used
2	TX	Transmit data
3	RX	Receiving line / Receive Data
4	nc	Not used
5	GND	Ground connection
6	DTR	Data set ready (+5 volt connected to output)
7	CTS	Clear to send
8	RTS	Request to send
9	VCC IN	4.5 – 5.5 V DC (if no power supply unit is connected to the power supply unit connection)

For the suitable power supply unit for IT 190x (100 - 230 V/50 – 60 Hz), see chapter 7. The power supply unit connection on the cable is not used.

3.1.2 KB PS2-1 IT190x Part no. 50114519

Helix cable, maximum length 3 m.

Pin assignments of the Mini DIN socket or connector for cable CBL-720-300-C00

Pin connector	Pin socket	Signal	Designation
1	-	PC Data	PC data line
2	2	NC	Not used
3	3	GND	Ground connection
4	4	VCC IN	5 Volts DC
5	-	PC Clock	PC clock line
6	6	NC	Not used
-	1	KB data	Keyboard data line
-	2	KB clock	Keyboard clock line

3.1.3 KB USB-1 IT 190x Part no. 50114521

Straight cable, maximum length 3 m.

Pin assignments of USB type A connector for cable CBL-500-300-S00

USB type A connector	Signal	Designation
1	VCC IN	5 Volts DC
2	Data -	Data line -
3	Data -	Data line +
4	GND	Ground connection

3.1.4 KB USB-2 IT 190x Part no. 50114523

Pin assignments of USB type A connector for cable CBL-500-500-C00:
as with part no. 50114521, but helix cable, maximum length 5 m.

3.2 Reading fields

IT 1911i ER-3

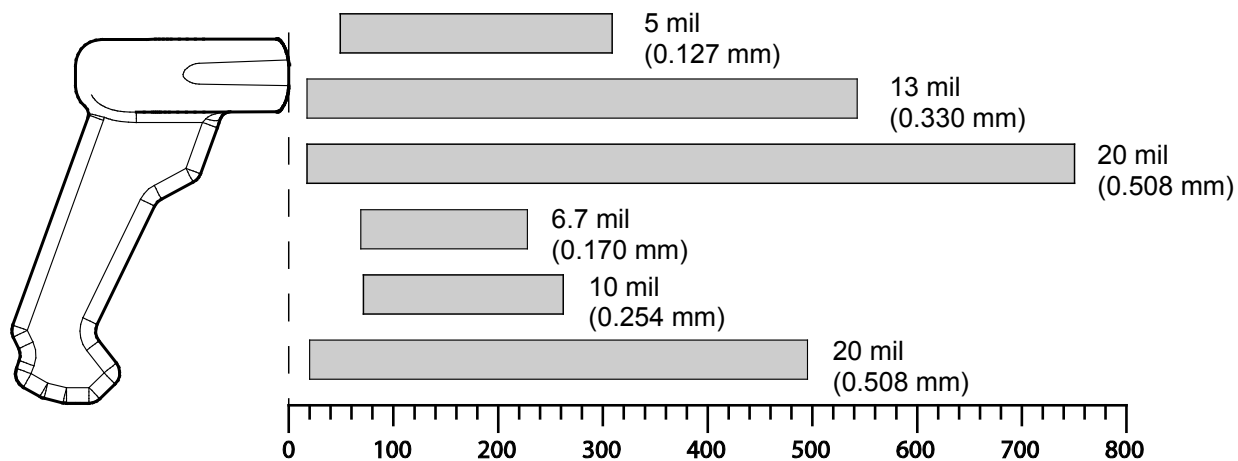

Typ. reading distance ¹⁾ [mm]

1) Dependent on code module

4 Resetting the IT 1911i to factory settings

To reset all parameters to factory settings, scan the bar code shown below.

 **Attention!**

All settings are lost!



Standard Product Default Settings

Return the IT 1911i to the base station so that the settings can be accepted. Successful reading is confirmed by an acoustic signal and the red LED on the base station going out briefly.

You may then continue making settings or operation of the device.

5 Configuration

Usually, bar codes are used to configure the hand-held scanner. Select the desired bar code and scan it (see chapter 2.3). The configuration is then immediately accepted and executed.

A second option is to configure the hand-held scanner with the USB and RS 232 interfaces with the aid of the VisualXpress PC program. You can download and install this program from our homepage at www.leuze.com. The program can be used to make settings and transfer them to the hand-held scanner. The configuration can also be stored so that it can be reused at a later time.

The standard applications are described and summarized below.

5.1 IT 1911i to the serial PC interface

5.1.1 With KB 232-1 IT190x Part no. 50114517

For pin assignments, see chapter 3.1.1.

Please connect the base station for IT 1911i acc. to the adjacent figure.

Required parts:

1x	50122434	IT 1911i ER-3
1x	50122431	Base station IT 1911i
1x	50114517	KB 232-1 IT 190x
1x	50123862	Power supply unit



RS-232 Interface

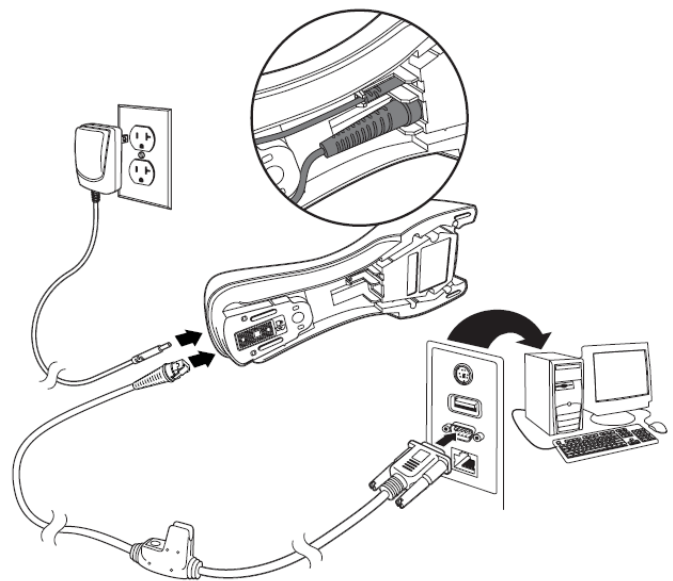

RS 232 transmission with 115200 baud, 8 data bits, 1 stop bit, no parity, suffix CR/LF.

Return the IT 1911i to the base station so that the settings can be accepted. Successful reading is confirmed by an acoustic signal and the red LED on the base station going out briefly.

5.1.2 Configuration for the Leuze standard protocol

Leuze standard protocol:

RS 232 with 9600 baud, 8 data bits, 1 stop bit, no parity, prefix STX and suffix CR/LF

Factory settings

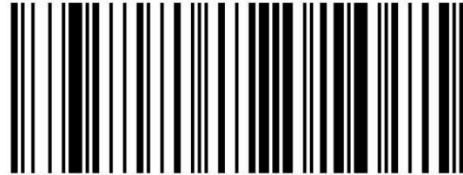

Return the IT 1911i to the base station so that the settings can be accepted. Successful reading is confirmed by an acoustic signal and the red LED on the base station going out briefly.

To configure the device, please scan the codes in the specified order.

Successful reading is confirmed by an acoustic signal and the red LED on the base station going out briefly.

RS 232 baud rate: 9600



Prefix STX



Suffix CR/LF



Alternatively, the following Aztec configuration code can also be used:

The individual pieces of bar code information are again provided in succession in the Aztec configuration code.

Return the IT 1911i to the base station so that the settings can be accepted. This procedure is concluded with an acoustic signal.



5.2 IT 1911i to MA 200i

RS 232 transmission with 9600 baud, 8 data bits, 1 stop bit, no parity, suffix CR/LF.

Required parts:

1x	50122434	IT 1911i ER-3	
1x	50122431	Base station IT 1911i	
1x	50114517	KB 232-1 IT 190x	
1x	50123862	Power supply unit	
1x	50113397	KB JST-HS-300	
1x	50112893	MA 204i	Profibus gateway
or	50112892	MA 208i	Ethernet gateway
or	50112891	MA 248i	Profinet gateway

5.2.1 Commissioning

- Open the MA 200i
- Guide KB JST-HS-300 with the PG cable gland through the threaded hole and insert the 12-pin JST connector
- Connect the base station with the RS 232 cable
- Connect the RS 232 cable to the 9-pin D-sub connector
- Set the address using the address switch
- Insert the field bus connection cable
- Apply the voltage supply.

Please connect the base station acc. to the following figure.

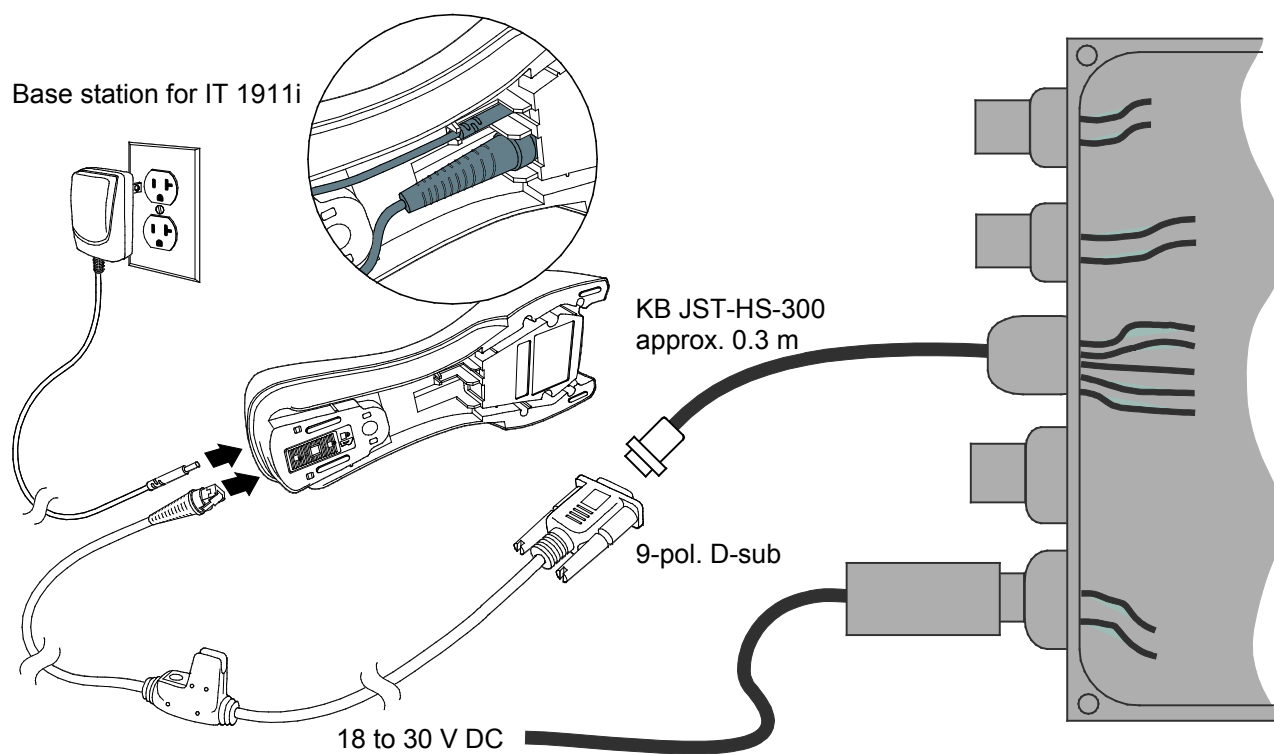

Details on connecting the MA 200i can be found in "Technical description MA 200i".

NOTICE

You can find the configuration codes on the next page.

5.2.1.1 Configuration

Factory settings



Return the IT 1911i to the base station so that the settings can be accepted. This procedure is concluded with an acoustic signal.

To configure the device, please scan the codes in the specified order.

Successful reading is confirmed by an acoustic signal and the red LED on the base station going out briefly.

RS 232 baud rate: 9600



Suffix CR/LF



Alternatively, the following Aztec configuration code can also be used:

The individual pieces of bar code information are again provided in succession in the Aztec configuration code.

Return the IT 1911i to the base station so that the settings can be accepted. This procedure is concluded with an acoustic signal.



5.3 IT 1911i to MA 21

RS 232 transmission with 9600 baud, 7 data bits, 1 stop bit, even parity, suffix CR/LF.

Required parts:

1x	50122434	IT 1911i ER-3
1x	50122431	Base station IT 1911i
1x	50114517	KB 232-1 IT190x
1x	50123862	Power supply unit
1x	50035421	KB 021 Z
1x	50030481	MA 21 100

5.3.1.1 Pin assignments KB021 Z

Core color	Signal	Terminal assignments MA 21
brown	(RXD)	26
white	(TXD)	27
blue	(GND)	28
red	(VCC)	⊗
black	(GND)	⊗
bare (shield)	(PE)	21

5.3.1.2 Configuration

Factory settings

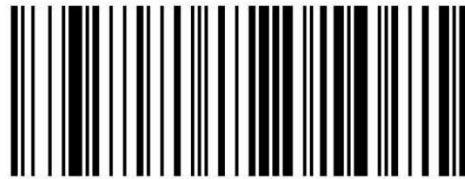

Return the IT 1911i to the base station so that the settings can be accepted. This procedure is concluded with an acoustic signal.

To configure the device, please scan the codes in the specified order.

Successful reading is confirmed by an acoustic signal and the red LED on the base station going out briefly.

RS 232 baud rate: 9600



7 data bits, even parity, 1 stop bit



Suffix CR/LF

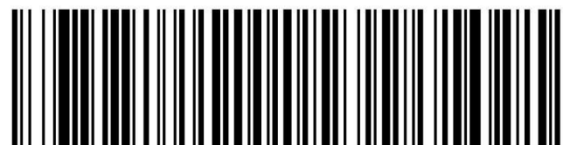

Alternatively, the following Aztec configuration code can also be used:

The individual pieces of bar code information are again provided in succession in the Aztec configuration code.

Return the IT 1911i to the base station so that the settings can be accepted. This procedure is concluded with an acoustic signal.



5.4 IT 1911i to PS2 interface

The operation of the IT 1911i in keyboard-wedge mode is described in this chapter. A PC keyboard is emulated in this operating mode. The data which are read in are written directly to the currently activated program. Thus, the data can be processed further in all standard programs.

Required parts:

1x	50122434	IT 1911i ER-3
1x	50122431	Base station IT 1911i
1x	50114519	KB PS2-1 IT190x
1x	50123862	Power supply unit

Please connect the base station acc. to the figure below.

To do this, proceed as follows:

1. Switch off the PC.
2. Unplug the keyboard.
3. Connect the cable for the base station between the keyboard and the PC.
4. Switch the PC back on.
5. Scan the code shown below.

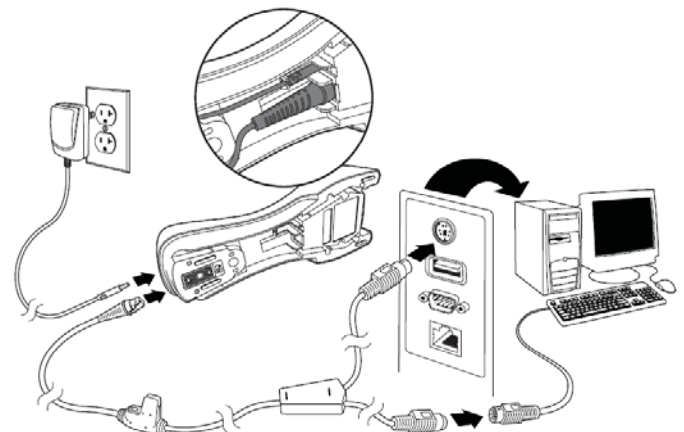
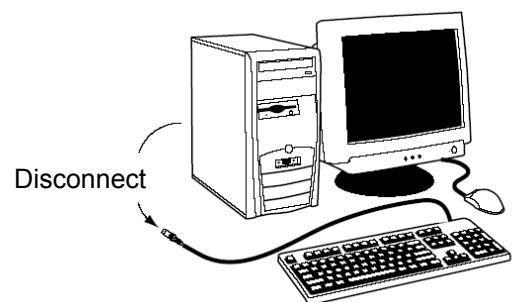

NOTICE

To charge the IT 1911i, the power supply unit must be plugged in and the hand-held scanner placed in the base station.

5.4.1.1 Configuration

PS2 keyboard emulation with CR LF

Return the IT 1911i to the base station so that the settings can be accepted. This procedure is concluded with an acoustic signal.



5.5 IT 1911i to USB interface (keyboard emulation)

The operation of the IT 1911 in keyboard-wedge mode on a USB port is described in this chapter. A PC keyboard is emulated in this operating mode. The data which are read in are written directly to the currently activated program. Thus, the data can be processed further in all standard programs.

Required parts:

1x	50122434	IT 1911i ER-3			
1x	50122431	Base station IT 1911i			
1x	50114521	KB USB-1 IT190x	or	50114523	KB USB-2 IT190x
1x	50123862	Power supply unit			

Please connect the base station acc. to the figure below.

To do this, proceed as follows:

1. Connect the cable for the base station to a free USB port.
2. The scanner acknowledges this connection with an acoustic signal.
3. Scan the code shown below.

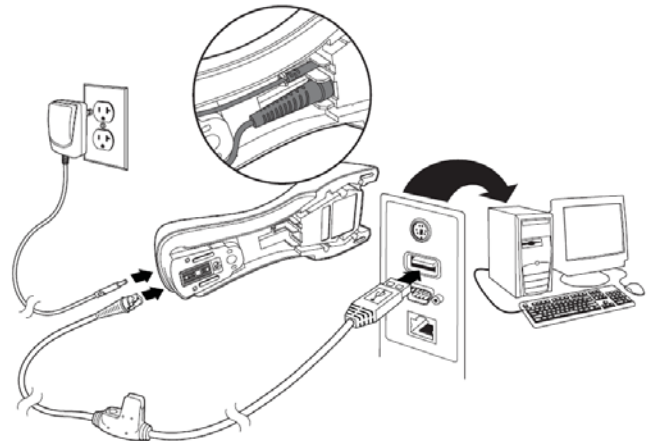

NOTICE

To charge the IT 1911i, the power supply unit must be plugged in and the hand-held scanner placed in the base station.

5.5.1.1 Configuration

USB keyboard emulation with CR LF

Return the IT 1911i to the base station so that the settings can be accepted. This procedure is concluded with an acoustic signal.



5.6 IT 1911i to USB interface (COM port emulation)

The operation of the IT 1911i as a serial interface on a USB port is described in this chapter. A COM interface is emulated in this operating mode. The data which are read in are sent to a new COM interface. The driver with which you emulate this COM interface can be downloaded from our homepage at www.leuze.com. Thus, the data can be processed further in programs which expect data via COM interfaces.

Required parts:

1x	50122434	IT 1911i ER-3		
1x	50122431	Base station IT 1911i		
1x	50114521	KB USB-1 IT190x	or	50114523 KB USB-2 IT190x
1x	50123862	Power supply unit		

Please connect the base station acc. to the figures below.

To do this, proceed as follows:

1. Install the USB serial driver for the IT 1911i.
2. Connect the cable for the base station to a free USB port.
3. The scanner acknowledges this connection with an acoustic signal.
4. Scan the code shown below.
5. Open a terminal program or your program for the serial interface, select the new COM port, and make the following settings: baud rate 115200, 8 data bits, 1 stop bit and no parity. A CR is transmitted as suffix (or terminator).

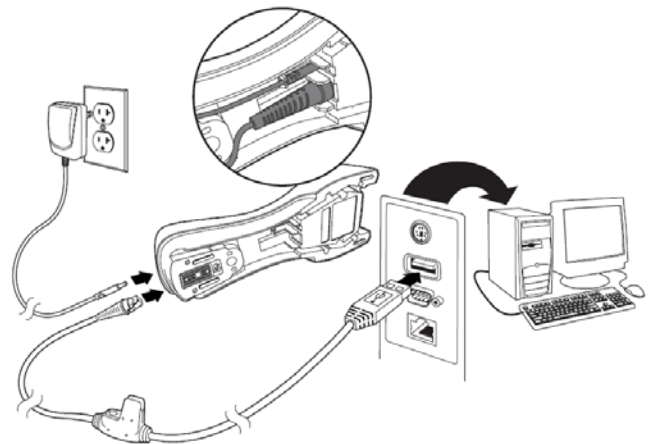

NOTICE

To charge the IT 1911i, the power supply unit must be plugged in and the hand-held scanner placed in the base station.

5.6.1.1 Configuration

COM port emulation on the next free COM address with 38400 baud, 8 data bits, 1 stop bit, no parity and a CR as suffix.



Return the IT 1911i to the base station so that the settings can be accepted. This procedure is concluded with an acoustic signal.

5.7 Activating the read process

To activate the read process, a trigger signal is to be sent via the serial RS 232 interface or USB interface (COM port emulation only). The command is to be sent at the set baud rate, parity, and data and stop bits.

The activation command is: **SYN T CR** ASCII decimal values: 022; 084; 013

To cancel read readiness, send a deactivation.

The deactivation command is: **SYN U CR** ASCII decimal values: 022; 085; 013

Following a successful read operation, the IT 1911i deactivates itself.

The second option is to use the trigger button to establish read readiness.

5.8 Configuration



Further details on configuration, such as parameters for code type release, number of digits, etc., can be found in the User's Guide IT 1910i/1911i.

5.9 Troubleshooting

For problem detection and troubleshooting, examine your scanner as follows:









1. If the scanner is supplied with power via the connection cable, the scanner and PC must be connected to each other before the scanner is commissioned. The PC must supply the scanner with 5 V DC. Check the manual for your PC to ensure that the power supply is adequate for connecting your scanner.
2. Make certain that the connection cable is securely connected to the PC. You can find information on properly connecting the scanner in the manual for your PC. Support is also available from your technical staff.
3. If your system operates with an external voltage supply, make certain that the power supply unit is properly connected to the scanner.
4. Check that the connection cable is securely connected to the base station. At the base station, please loosen the cable using a small pin: the connector is unlocked.
5. If, even after performing all of these measures, the scanner is not ready for operation, replace the power supply unit with a different recommended power supply unit which you are certain functions properly.
6. Make certain that your scanner's interface is compatible with the PC. Further information on this topic can be found in the manual for your PC. Also check whether the scanner has been configured for the desired application. This information is given in the User's Guide IT 1910i/1911i.
7. Check whether the bar code labels which you would like to scan are of suitable quality and that the used bar code type is recognized by your scanner. Damaged bar code labels (crinkled, torn or soiled) may be recognized poorly or not at all by the scanner. If you suspect that the problem lies with the quality of the label, check the read readiness with a label of relatively good quality.
8. If the problems are still not corrected, please contact the Leuze electronic hotline (see chapter 8).

6 Type overview

IT series			
Part no.	Designation	Interface	Figure
Industrial hand-held reader for bar codes and 2D-codes			
50122434	IT 1911i ER-3	Bluetooth class 1	
Base station with communication and charging function			
50122431	Base station for IT 1911i	Bluetooth class 1 PS2 / USB / TTL RS 232	

All devices are supplied without cable. Cables must be ordered separately; see chapter "7 Accessories/Spare parts".

7 Accessories/Spare parts

Accessories for IT series					IT 1911i	Base station for IT 1911i
Part no.	Designation	Length, type	P/N no.	Figure		5V
50114519	KB PS2-1 IT 190x PS2 cable for IT 190x	3 m spiral	CBL-720-300-C00		-	X
50114521	KB USB-1 IT 190x USB cable for IT 190x	3 m straight	CBL-500-300-S00		-	X
50114523	KB USB-2 IT 190x USB cable for IT 190x	5 m spiral	CBL-500-500-C00		-	X
50114517	KB 232-1 IT 1900 RS 232 cable for IT 190x	3 m spiral	CBL-020-300-C00		-	X
50123862	NT Base IT 1911i Voltage supply for the base station (5 V DC), RS 232 cable and base station	1.8 m straight	PS-05-1000W-C		-	X
50105384	Battery for IT 1911i, 3820, 4820 and IT 6320	3.7 V / 2000 mAh	100000495		X	-
50114494	BAT-Charger-4 Desk-EU Charging station with power supply unit for up to 4 batteries	2 x 1.5 m straight	MB4-BAT-SCN01EUD0		X	-
50120444	BT Wallholder HS65x8	wall mount; plastic	11-66553-06R		X	
50107034	Rope for IT3800i/4800/6300	steel rope; plastic	ToolBaIE		X	

7.1 Connecting to Leuze multiNet Plus

- MA 21 100 Interface converter / multiNet plus Part no. 50030481
- KB 021 Z Connection cable MA xx to IT 1911i Part no. 50035421

7.2 Connection to various fieldbuses using MA 200i

- MA 204i **Profibus** gateway Part no. 50112893
or
- MA 208i **Ethernet** gateway Part no. 50112892
or
- MA 248i **Profinet** gateway Part no. 50112891
- KB JST-HS-300 Connection cable MA xx to IT 1911i Part no. 50113397

8 Service and support

24-hour on-call service at:

+49 (0) 7021 573-0

Service hotline:

+49 (0) 7021 573-123

Monday to Thursday 8.00 a.m. to 5.00 p.m. (UTC+1)

Friday 8.00 a.m. to 4.00 p.m. (UTC+1)

E-mail:

service.identify@leuze.de

Return address for repairs:

Service center

Leuze electronic GmbH + Co. KG

In der Braike 1

D-73277 Owen / Germany